

BUY WITH CONFIDENCE.

Over 10,000 items shipped the same day from our ISO 9001:2000 quality certified facility. From Advantage to Shome, we sell the best products at the best possible prices and back them with our 100% satisfaction guarantee.

FAUCETS AND EXTERNAL TRIM

ADVANTAGE™
Heavy Duty Commercial
Grade Deck Mount
Pre-rinse Unit

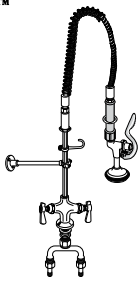

SEE PAGE 196
18-110

ADVANTAGE™
3-1/2" Sink
Opening x 2"
Drain Opening
Heavy Duty
Commercial Twist
Handle Waste

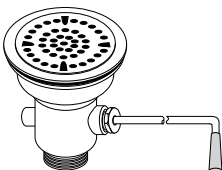

SEE PAGE 215
55-735

Alsons™
Chrome Plated
Hand Held Shower
Complete Assembly



SEE PAGE 249
13-237

**American
PLUMBER™**
Slimline Under-Sink
Water Filter



SEE PAGE 217
55-063

GERBER
Brass Trip
Waste & Overflow

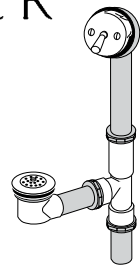

SEE PAGE 246
53-111

**ISE
IN-SINK-ERATOR**
3/4 Horsepower
Stainless Steel
Food Waste Disposer
Compact



SEE PAGE 220
54-202

NEOPERL®
Chromed Brass
Combo Slotless
Aerator



SEE PAGE 232
23-144

**DELTA
FAUCET COMPANY**
GENUINE PARTS
Lavatory & Kitchen
REBUILD KIT



SEE PAGE 237
22-882

ADVANTAGE™
Chrome Plated
Cast Brass Washerless
Two Handle
Lavatory Faucet

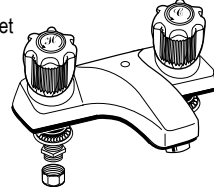

SEE PAGE 201
19-160

ADVANTAGE™
Chrome Plated
Cast brass Washerless
Single Lever Handle
Kitchen Faucet
with Spray



SEE PAGE 200
19-651

Kwik-Rinse™
Spray Head
100% water and
air tested before
shipment



SEE PAGE 230
23-261

Chrome Plated Cast Brass
Compression Two Handle
Add-a-Shower Complete for
Leg Tubs

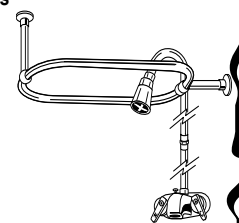

SEE PAGE 211
14-405

USE YOUR CREDIT CARD AT TIME OF PURCHASE AND **SAVE 2% ON ALL ORDERS,**
SAVE 5% ON ALL ORDERS OVER \$500 OR SAVE 10% ON ALL ORDERS OVER \$1000

FAX **1-800-982-5934** www. **HODES CO.** .com PHONE **1-800-777-6500**
PREFERRED PLUMBING PRODUCTS 193



ADVANTAGE™

COMMERCIAL, HEAVY DUTY COMBINATION WALL FAUCET FOOD SERVICE GRADE WITH 8" SPOUT

COMPARE TO:
CHICAGO #540LD-L8
FISHER #3251
T&S #B230 W60X

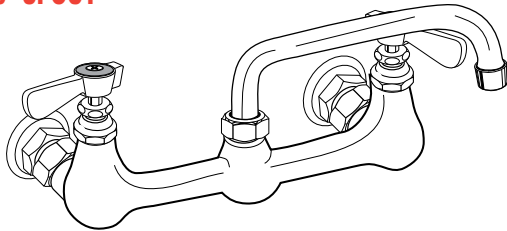

- 8" center
- Heavy duty construction with extra heavy chrome plating
- Solid brass casting
- 1/2" IPS connections
- Internal parts interchangeable with other major brands repair parts
- Complete line of repair parts available
- 8" Heavy duty swing spout
- Complies with all low lead requirements of NSF 61 and California proposition 65
- 1 per box - 6 per case

18-100 Genuine Advantage Wall Faucet With 8" Spout **94.55**

ADVANTAGE™

COMMERCIAL, HEAVY DUTY COMBINATION WALL FAUCET FOOD SERVICE GRADE WITH 10" SPOUT

COMPARE TO:
CHICAGO #540LD-L9
FISHER #3252
T&S #B230 W61

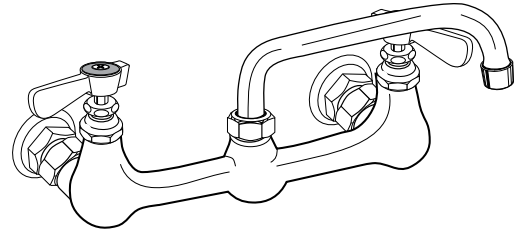

- 8" center
- Heavy duty construction with extra heavy chrome plating
- Solid brass casting
- 1/2" IPS connections
- Internal parts interchangeable with other major brands repair parts
- Complete line of repair parts available
- 10" Heavy duty swing spout
- Complies with all low lead requirements of NSF 61 and California proposition 65
- 1 per box - 6 per case

18-101 Genuine Advantage Wall Faucet With 10" Spout **96.78**

ADVANTAGE™

COMMERCIAL, HEAVY DUTY COMBINATION WALL FAUCET FOOD SERVICE GRADE WITH 12" SPOUT

COMPARE TO:
CHICAGO #540LD-L12
FISHER #3253
T&S #B231

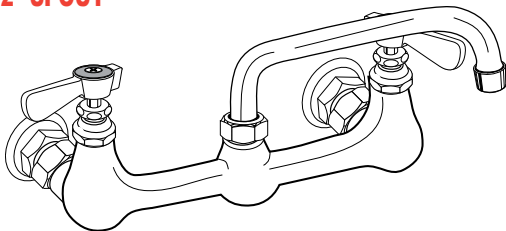

- 8" center
- Heavy duty construction with extra heavy chrome plating
- Solid brass casting
- 1/2" IPS connections
- Internal parts interchangeable with other major brands repair parts
- Complete line of repair parts available
- 12" Heavy duty swing spout
- Complies with all low lead requirements of NSF 61 and California proposition 65
- 1 per box - 6 per case

18-102 Genuine Advantage Wall Faucet With 12" Spout **99.88**

ADVANTAGE™

COMMERCIAL, HEAVY DUTY COMBINATION WALL FAUCET FOOD SERVICE GRADE WITH 14" SPOUT

COMPARE TO:
CHICAGO #540LD-L15
FISHER #3254
T&S #B230 W63X

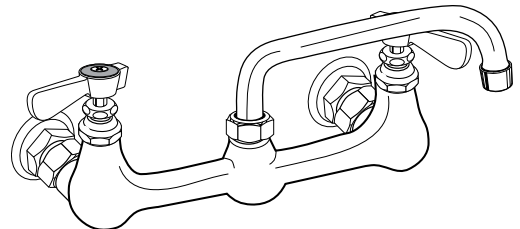

- 8" center
- Heavy duty construction with extra heavy chrome plating
- Solid brass casting
- 1/2" IPS connections
- Internal parts interchangeable with T&S™ and Dormont™ repair parts
- Complete line of repair parts available
- 14" Heavy duty swing spout
- Complies with all low lead requirements of NSF 61 and California proposition 65
- 1 per box - 6 per case

18-103 Genuine Advantage Wall Faucet With 14" Spout **102.39**

USE YOUR CREDIT CARD AT TIME OF PURCHASE AND SAVE 2% ON ALL ORDERS, SAVE 5% ON ALL ORDERS OVER \$500 OR SAVE 10% ON ALL ORDERS OVER \$1000

FAX 1-800-982-5934 www.HODES CO.com PHONE 1-800-777-6500
194 **HODES CO. PROFFERED PLUMBING PRODUCTS**



ADVANTAGE™

**AUTOMATIC
WORK RANGE FAUCET
FOOD SERVICE GRADE**

COMPARE TO:
CHICAGO #334
FISHER #4750
T&S #B578-1

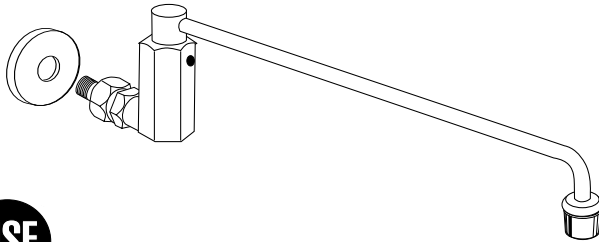

- Heavy duty chrome plated construction
- 12" spout
- 3/8" MIP with flange
- Swing spout forward to turn on, back to turn off
- Complies with all low lead requirements of NSF 61 and California proposition 65
- 1 per box - 20 per case

18-109 Genuine Advantage 12" Spout **33.06**

ADVANTAGE™

**HEAVY DUTY
ADD-ON FAUCET**

COMPARE TO:
CHICAGO #G13A-56
FISHER #2901
T&S #B155

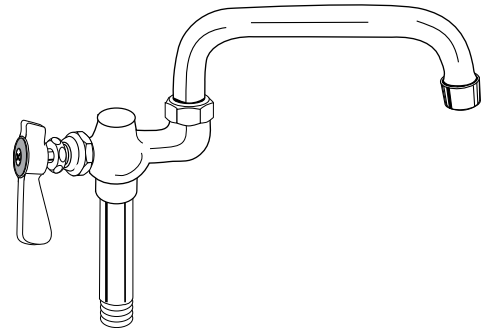

- 6" spout
- Heavy duty chrome plated brass construction
- Use with Advantage™ pre-rinse units
- Fits T&S™ and other major brands pre-rinse units
- Complies with all low lead requirements of NSF 61 and California proposition 65
- 1 per box - 6 per case

18-112 Genuine Advantage Add-On Faucet with 6" Spout **50.72**

ADVANTAGE™

**COMMERCIAL
SERVICE
SINK FAUCET**

COMPARE TO:
CHICAGO #897RF
T&S #B665-BSTR

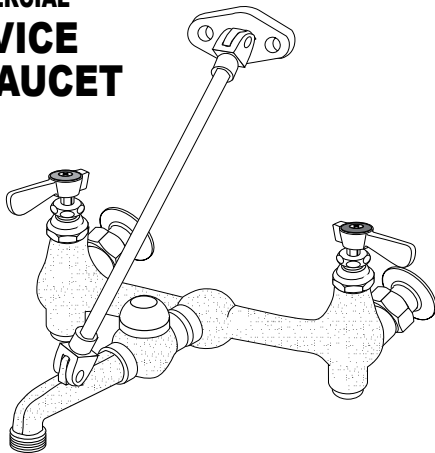

- Heavy duty chrome plated rough brass construction
- 8" center, 7" rigid spout
- 1/2" NPT inlets, 3/4" hose thread outlet
- Pail hook and top brace
- With vacuum breaker and wall flange
- Built-in stop device with screwdriver slot provides separate shut off for each valve
- 1 per box - 4 per case

18-150 Genuine Advantage Service Sink Faucet. **138.26**

**INNOVATIVE SOLUTIONS
FOR
PROGRESSIVE PLUMBERS**

Custom product labeling
Bar coded bin labels
Scanning reorder devices
Customized min/max stock levels
for your shop inventory
Shelving, bin boxes, software, shop
& truck design

HONOR THY PLUMBER™

**USE YOUR CREDIT CARD AT TIME OF PURCHASE AND SAVE 2% ON ALL ORDERS,
SAVE 5% ON ALL ORDERS OVER \$500 OR SAVE 10% ON ALL ORDERS OVER \$1000**

FAX 1-800-982-5934 www.HODESCO.com PHONE 1-800-777-6500





ADVANTAGE™
**HEAVY DUTY
COMMERCIAL GRADE
DECK MOUNT
PRE-RINSE UNIT**

COMPARE TO:
CHICAGO #919
FISHER #2110WB
T&S #B113B

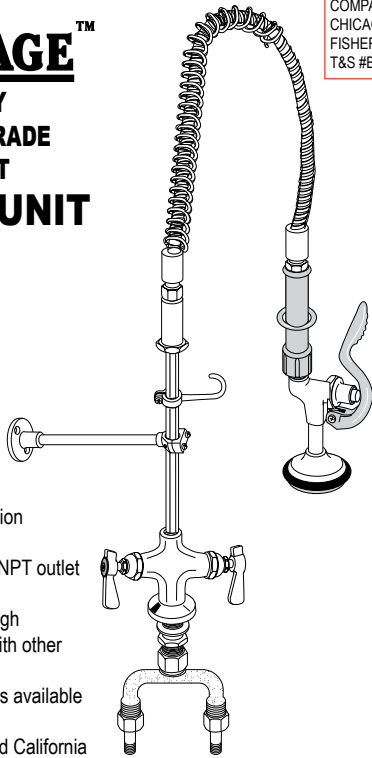

- Deck mount
- Single hole, 4" centers
- Heavy duty brass construction
- Chrome plated
- Universal 1/4" NPT or 1/2" NPT outlet
- 12" wall bracket included
- Unit is approximately 45" high
- All parts interchangeable with other major brands
- Complete line of repair parts available
- Complies with all low lead requirements of NFS 61 and California proposition 65

18-110 Genuine Advantage Deck Mount Pre-Rinse Faucet **220.52**

ADVANTAGE™
**HEAVY DUTY
COMMERCIAL GRADE
WALL MOUNT
PRE-RINSE UNIT**

COMPARE TO:
CHICAGO #510GC
FISHER #2110WB
T&S #B133B

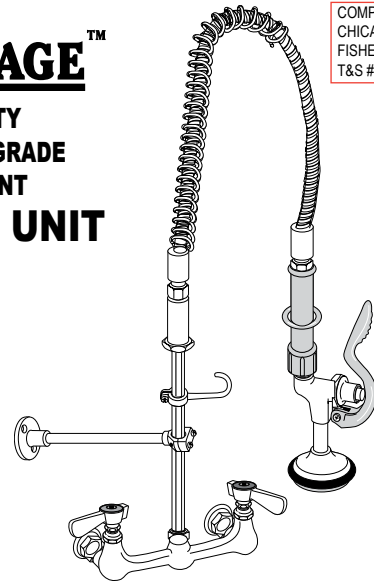

- Wall mount
- Heavy duty chrome plated brass construction
- 1/2" FIP inlets
- 8" centers
- 12" wall bracket included
- Unit is approximately 45" high
- All parts interchangeable with other major brands
- Complete line of repair parts available
- Complies with all low lead requirements of NSF 61 and California proposition 65

18-111 Genuine Advantage Wall Mount Pre-Rinse Faucet **220.52**

ADVANTAGE™
**INTERNAL
REPAIR KIT**

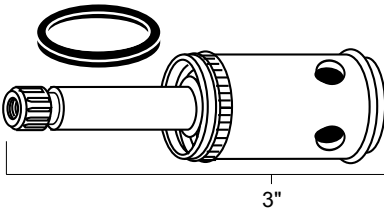

3"



- Contains all parts required to rebuild and repair Advantage™ Faucets #18-100, 18-101, 18-102, 18-103 and pre rinse units #18-110, 18-111, 18-112
- Interchangeable with other major brands of faucets
- Complies with all low lead requirements of NSF 61 and California proposition 61

28-125L Genuine Advantage Cold Side Repair Kit **23.60**
28-125R Genuine Advantage Hot Side Repair Kit **23.60**



SAME DAY SHIPPING

Same day shipping is available on all orders placed by 4:00 p.m. E.S.T. (including private label orders!!). Deliveries are Monday – Friday. Most customers in the contiguous U.S. receive their order just 1 to 2 days after we send it out. Large items shipped by freight line may take longer. Customers located in 2 or 3 day ship areas may request Priority Overnight Service.

**USE YOUR CREDIT CARD AT TIME OF PURCHASE AND SAVE 2% ON ALL ORDERS,
SAVE 5% ON ALL ORDERS OVER \$500 OR SAVE 10% ON ALL ORDERS OVER \$1000**



ADVANTAGE™

COMPARE TO:
CHICAGO #87-30
FISHER #2918
T&S #B44H

PRE-RINSE UNIT FOOD SERVICE GRADE 44" HOSE ASSEMBLY

- Stainless steel flexible hose
- Includes handle
- Reinforced spring collar for improved durability and flexibility
- Interchangeable with other major brands
- Complies with all low lead requirements of NSF 61 and California proposition 65
- 1 per package - 12 per case

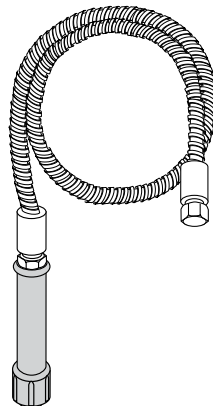

18-113 Genuine Advantage 44" Hose Assembly **55.78**

ADVANTAGE™

COMPARE TO:
CHICAGO #87-45
FISHER #2918-60
T&S #B60H

PRE-RINSE UNIT FOOD SERVICE GRADE 60" HOSE ASSEMBLY

- Stainless steel flexible hose
- Includes handle
- Reinforced spring collar for improved durability and flexibility
- Interchangeable with other major brands
- Complies with all low lead requirements of NSF 61 and California 65
- 1 per package - 12 per case

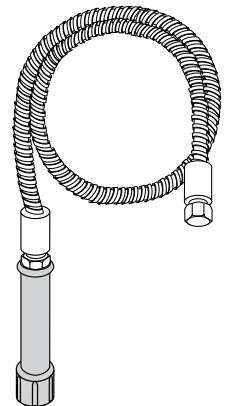

18-114 Genuine Advantage 60" Hose Assembly **57.74**

ADVANTAGE™

COMPARE TO:
CHICAGO #87-54
FISHER #2918-68
T&S #B68H

PRE-RINSE UNIT FOOD SERVICE GRADE 72" HOSE ASSEMBLY

- Stainless steel flexible hose
- Includes handle
- Reinforced spring collar for improved durability and flexibility
- Interchangeable with other major brands
- Complies with all low lead requirements of NSF 61 and California proposition 65
- 1 per package - 12 per case

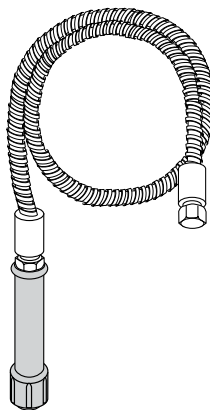

18-115 Genuine Advantage 72" Hose Assembly **76.63**

ADVANTAGE™

PRE-RINSE UNIT SPRING

- Chrome plated finish
- Heat treated steel
- Interchangeable with other major brands
- 1 per package - 12 per case

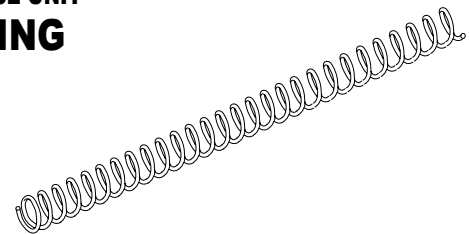

18-120 Genuine Advantage Spring **13.86**

ADVANTAGE™

COMPARE TO:
T&S #2856-40

PRE-RINSE UNIT SPRAY VALVE BONNET ASSEMBLY

- Replacement bonnet assembly for Advantage spray valve #18-116 and pre-rinse units 18-110 and 18-111
- Interchangeable with other major brands
- Complies with all low lead requirements of NSF 61 and California proposition 65
- 1 per package - 12 per case

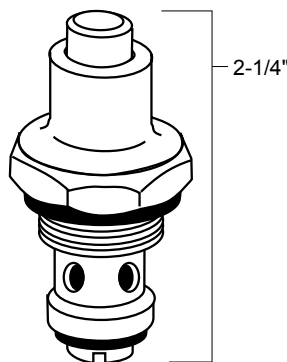

18-117 Genuine Advantage Bonnet Assembly **22.19**

ADVANTAGE™

COMPARE TO:
CHICAGO #80
FISHER #2949
T&S #B107

PRE-RINSE UNIT SPRAY VALVE ASSEMBLY

- Heavy duty construction
- Easy grip, contour handle
- Includes locking ring
- Interchangeable with other major brands
- Complies with all low lead requirements of NSF 61 and California proposition 65
- 1 per package - 6 per case

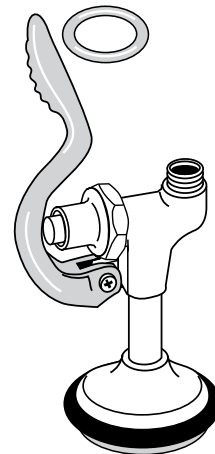

18-116 Genuine Advantage Spray Valve Assembly **37.48**

USE YOUR CREDIT CARD AT TIME OF PURCHASE AND SAVE 2% ON ALL ORDERS, SAVE 5% ON ALL ORDERS OVER \$500 OR SAVE 10% ON ALL ORDERS OVER \$1000

**FAX
1-800-982-5934**

www.HODES CO.com
PREFERRED PLUMBING PRODUCTS

**PHONE
1-800-777-6500**



ADVANTAGE™

**PRE-RINSE UNIT
SPRING
RETAINER**

COMPARE TO:
FISHER #2924-6000
T&S #821-40

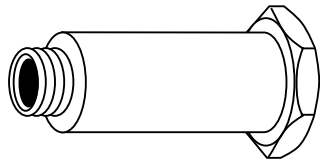

- Chrome plated finish
- Fits standard 3/8" risers
- 1 per package - 6 per case

18-121 Genuine Advantage Spring Retainer **12.82**

ADVANTAGE™

**PRE-RINSE UNIT
RISER HOOK**

COMPARE TO:
CHICAGO #850
FISHER #2907
T&S #B166

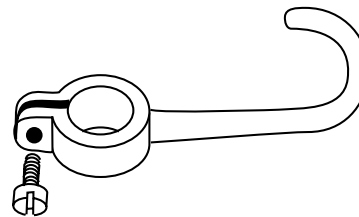

- Chrome plated finish
- Universal fit
- 1 per package - 6 per case

18-124 Genuine Advantage Riser Hook **10.23**

ADVANTAGE™

**PRE-RINSE UNIT
RISER**

COMPARE TO:
FISHER #2927-4300
T&S #369-40

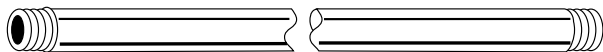

- Chrome plated finish
- 3/8" MIP
- 24" length
- Complies with all low lead requirements of NSF 61 and California proposition 65
- 1 per package - 6 per case

18-122 Genuine Advantage Riser **27.58**

ADVANTAGE™

**PRE-RINSE UNIT
WALL BRACKET**

COMPARE TO:
CHICAGO #903Q
FISHER #2902-12
T&S #B109

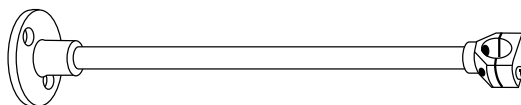

- Chrome plated finish
- Universal fit
- 12" length
- 1 per package - 6 per case

18-123 Genuine Advantage Wall Bracket **20.80**

ADVANTAGE™

ADVANTAGE™

**PRE-RINSE UNIT
SPRAY VALVE
BUMPER RING**

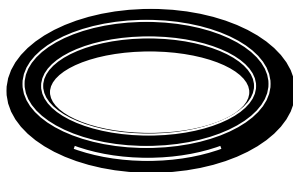

- Fits Advantage spray valve #18-116
- Interchangeable with other major brands
- Complies with all low lead requirements of NSF 61 and California proposition 65
- 3 per package - 36 per case

SOLD 3 PER PACKAGE ONLY

18-118 Genuine Advantage Bumper Ring **2.71**

ADVANTAGE™

**PRE-RINSE UNIT
SPRAY VALVE
FACE PLATE**

COMPARE TO:
T&S #1121-45

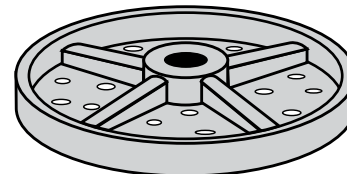

- Fits Advantage spray valve #18-116
- Interchangeable with other major brands
- Complies with all low lead requirements of NSF 61 and California proposition 65
- 1 per package - 12 per case

18-119 Genuine Advantage Spray Valve Face Plate **4.23**

**USE YOUR CREDIT CARD AT TIME OF PURCHASE AND SAVE 2% ON ALL ORDERS,
SAVE 5% ON ALL ORDERS OVER \$500 OR SAVE 10% ON ALL ORDERS OVER \$1000**



How Would You Like to See Your Name on the Products You Sell and Install?

Well, now you can. Advertise your business with every product you purchase from Hodesco. Just imagine the impact of YOUR LOGO and YOUR PHONE NUMBER appearing on each product. Without private labels, you receive a yellow Hodesco label. The labels shown to the right go to customers already on the program. Order yours today!



HOW MUCH DOES IT COST?

ABSOLUTELY FREE - ALWAYS!!

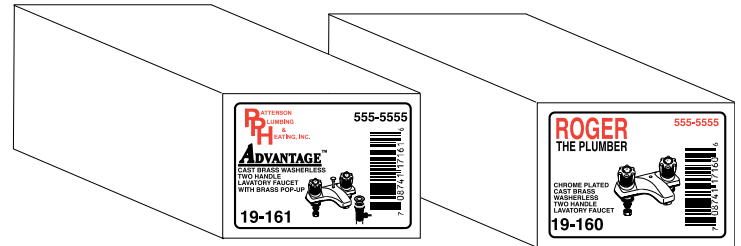

IT'S AS EASY AS 1-2-3!

1. Fax or mail your logo or business card.
2. Choose your label color:
 - White (Blue Ink)
 - White (Red Ink)
 - White (Green Ink)
 - White (Black Ink)
 - Yellow (PANTONE Yellow)
3. We'll keep this information on file and you can have every order private labeled!

HONOR THY PLUMBER™

PRIVATE LABELS

USE YOUR CREDIT CARD AT TIME OF PURCHASE AND SAVE 2% ON ALL ORDERS, SAVE 5% ON ALL ORDERS OVER \$500 OR SAVE 10% ON ALL ORDERS OVER \$1000

FAX 1-800-982-5934 www.HODESCO.com PHONE 1-800-777-6500





ADVANTAGE™

**CHROME PLATED
CAST BRASS WASHERLESS
SINGLE LEVER HANDLE
KITCHEN FAUCET**

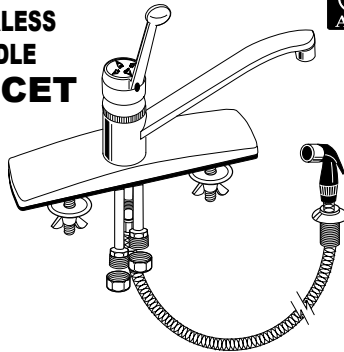

- Solid brass construction
- Adjustable 6" and 8" centers
- 1/2" IPS connections
- Deluxe chrome finish
- 2.0 GPM at 60 PSI
- 100% Water and Air Tested
- NSF certified
- ISO 9002 certified
- UPC/IAPMO approved
- On/off, hot/cold color handle indicators
- 1 per bar coded display box 6 per case

19-650 Kitchen Faucet less Spray **57.43**
19-651 Kitchen Faucet with Spray(shown) **59.70**

ADVANTAGE™

**CHROME PLATED
CAST BRASS WASHERLESS
TWO HANDLE
KITCHEN FAUCET**

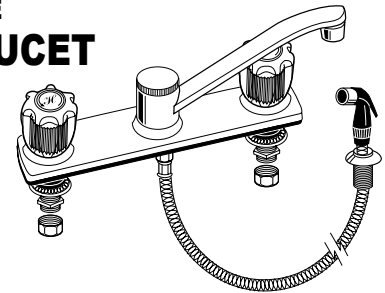

- Solid brass construction
- 8" centers
- 1/2" IPS connections
- Acrylic handles
- Deluxe chrome finish
- 2.0 GPM at 60 PSI
- NSF certified
- UPC/IAPMO approved
- ISO 9002 certified
- 1 per bar coded display box 6 per case

19-550 Kitchen Faucet less Spray **37.44**
19-551 Kitchen Faucet with Spray(shown) **43.91**

ADVANTAGE™

**CHROME PLATED
CAST BRASS CERAMIC DISC
TWO HANDLE GOOSENECK
KITCHEN FAUCET**

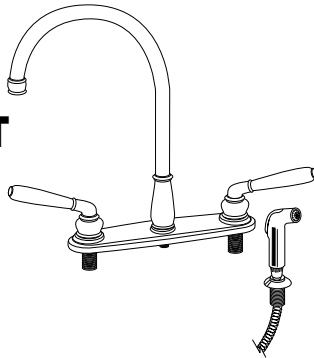

- Solid brass construction
- 8" centers
- 1/2" IPS connections
- Brass deco lever handles
- Brass waterways
- 12" hi-arc gooseneck spout
- 8 1/2" reach
- NSF certified UPC/IAPMO approved
- 1 per bar coded display box 6 per case
- ISO 9002 certified

19-750 Kitchen Faucet less Spray **65.02**
19-751 Kitchen Faucet with Spray(shown) **72.11**

ADVANTAGE™

**CHROME PLATED
CAST BRASS CERAMIC DISC
SINGLE LEVER HANDLE
KITCHEN FAUCET**

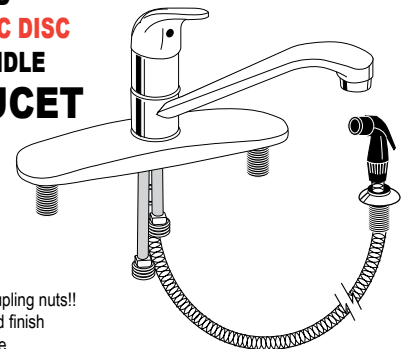

- 8" centers 1/2" IPS connections
- 100% water and air tested
- 2.0 GPM at 60 PSI
- NSF certified
- ISO 9002 certified
- UPC/IAPMO approved
- Hot/cold color handle indicator
- With solid forged brass locknuts & coupling nuts!!
- Lifetime warranty on workmanship and finish
- 1 per bar coded display box 6 per case

19-470 Chrome Kitchen Faucet less Spray **91.58**
19-471 Chrome Kitchen Faucet with Spray(shown) **96.86**

ADVANTAGE™

ADVANTAGE™

**CHROME PLATED
CAST BRASS CERAMIC DISC
SINGLE LEVER HANDLE
KITCHEN FAUCET
WITH PULL-OUT SPRAY SPOUT**

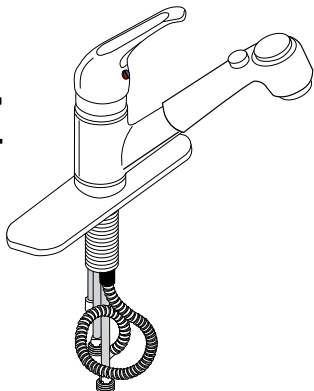

- Solid brass construction
- For 3 hole sinks
- 1/2" IPS connections
- Chrome finish
- 2.0 GPM at 60 PSI
- Pull-out spray spout
- Push button aerated stream or rinsing spray
- 59" retractable hose
- ISO 9002 certified
- UPC/IAPMO approved
- NSF certified
- Hot/cold color handle indicators
- 1 per bar coded display box 6 per case

19-265 Kitchen Faucet with Pull-Out Spray **129.36**

ADVANTAGE™

**CHROME PLATED
CAST BRASS WASHERLESS
SINGLE LOOP HANDLE
KITCHEN FAUCET
WITH SPRAY**

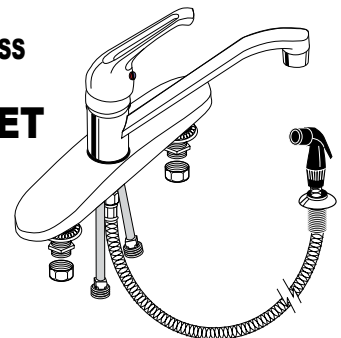

- Solid brass construction
- 8" centers
- 1/2" IPS connections
- Deluxe chrome finish
- 2.0 GPM at 60 PSI
- Includes spray head and hose
- 100% Water and Air Tested
- NSF certified
- ISO 9002 certified
- UPC/IAPMO approved
- Hot/cold color handle indicator
- 1 per bar coded display box 6 per case

19-461 Chrome Kitchen Faucet with Spray **58.88**

EUROSTYLE

**USE YOUR CREDIT CARD AT TIME OF PURCHASE AND SAVE 2% ON ALL ORDERS,
SAVE 5% ON ALL ORDERS OVER \$500 OR SAVE 10% ON ALL ORDERS OVER \$1000**

Fax 1-800-982-5934 www.HODESCO.com PHONE 1-800-777-6500
200 **HODESCO** PREFERRED PLUMBING PRODUCTS

BAR & LAVATORY FAUCETS



FAUCETS AND EXTERNAL TRIM

ADVANTAGE™

CHROME PLATED CAST BRASS WASHERLESS TWO HANDLE BAR FAUCET

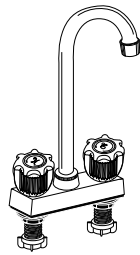

- Solid brass construction
- 4" centers 1/2" IPS connections
- Acrylic handles Chrome finish
- 10" high tubular spout
- 2.0 GPM at 60 PSI
- NSF certified
- ISO 9002 certified
- UPC/IAPMO approved
- 1 per bar coded display box
- 6 per case

19-174 Bar Faucet **35.27**

ADVANTAGE™

CHROME PLATED CAST BRASS WASHERLESS SINGLE HANDLE LAVATORY FAUCET WITH BRASS POP-UP ASSEMBLY

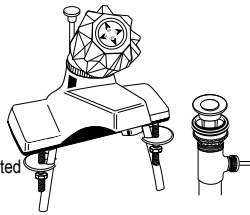

- Solid brass construction
- 4" centers
- Copper connections
- Acrylic handle
- Deluxe chrome finish
- 2.0 GPM at 60 PSI
- Includes brass pop-up assembly
- 100% Water and Air Tested
- NSF certified
- UPC/IAPMO approved
- ISO 9002 certified
- 1 per bar coded display box
- 6 per case

19-356 Lavatory Faucet with Brass Pop-Up **47.91**

ADVANTAGE™

CHROME PLATED CAST BRASS WASHERLESS LEVER HANDLE LAVATORY FAUCET



NEW

19-363 Lever Handle Lavatory Faucet **42.26**

ADVANTAGE™

CHROME PLATED CAST BRASS WASHERLESS TWO HANDLE LAVATORY FAUCET

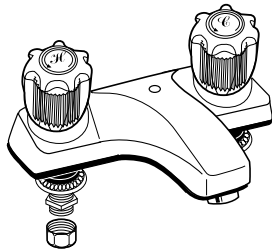

- Solid brass construction
- 4" centers
- 1/2" IPS connections
- Acrylic handles
- Deluxe chrome finish
- 2.0 GPM at 60 PSI
- 100% Water and Air Tested
- NSF certified
- UPC/IAPMO approved
- ISO 9002 certified
- 1 per bar coded display box
- 6 per case

19-160 Lavatory Faucet **27.81**

ADVANTAGE™

CHROME PLATED CAST BRASS CERAMIC DISC SINGLE LEVER HANDLE LAVATORY FAUCET WITH 7" SUPPLIES

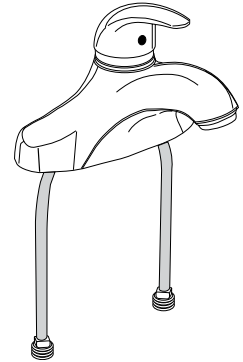

- 100% water and air tested
- 2.0 GPM at 60 PSI
- 4" centers
- NSF certified
- ISO 9002 certified
- UPC/IAPMO approved
- Lifetime warranty on workmanship and finish
- 1 per bar coded display box 6 per case

19-371 Lavatory Faucet with Pop-Up **74.09**

ADVANTAGE™

CHROME PLATED CAST BRASS WASHERLESS SINGLE HANDLE LAVATORY FAUCET WITH BRASS POP-UP ASSEMBLY

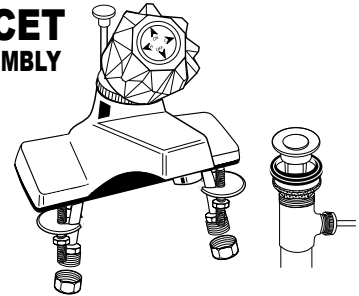

- Solid brass construction
- 4" centers
- 1/2" IPS connections
- Acrylic handle
- Deluxe chrome finish
- 2.0 GPM at 60 PSI
- Includes brass pop-up assembly
- 100% Water and Air Tested
- NSF certified
- UPC/IAPMO approved
- ISO 9002 certified
- 1 per bar coded display box
- 6 per case

19-361 Lavatory Faucet with Brass Pop-Up **38.98**

ADVANTAGE™

CHROME PLATED CAST BRASS WASHERLESS TWO HANDLE LAVATORY FAUCET WITH BRASS POP-UP ASSEMBLY

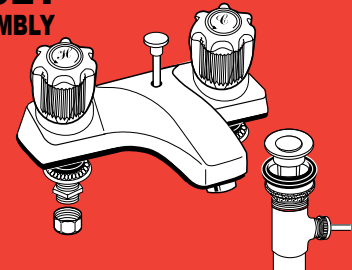

- Solid brass construction
- 4" centers
- 1/2" IPS connections
- Acrylic handles
- Deluxe chrome finish
- 2.0 GPM at 60 PSI
- Includes brass pop-up assembly
- 100% Water and Air Tested
- UPC/IAPMO approved
- ISO 9002 certified
- 1 per bar coded display box 6 per case
- NSF certified

19-161 Lavatory Faucet with Brass Pop-Up **35.57**

USE YOUR CREDIT CARD AT TIME OF PURCHASE AND SAVE 2% ON ALL ORDERS, SAVE 5% ON ALL ORDERS OVER \$500 OR SAVE 10% ON ALL ORDERS OVER \$1000

FAX 1-800-982-5934 www.HODES CO.com PHONE 1-800-777-6500
PROFFERED PLUMBING PRODUCTS 201

ADVANTAGE™



Case Lot Pricing
available at

www.HodesCo.com

ADVANTAGE™
CHROME PLATED CAST BRASS
COMPRESSION HANDLE
SHOWER FAUCET

LIMITED LIFETIME WARRANTY

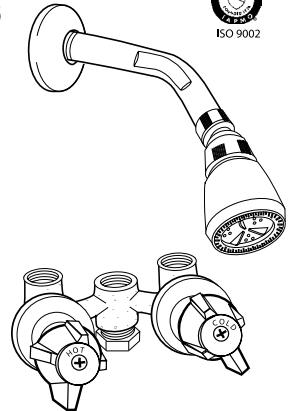

- 3-3/8" centers
- Solid brass construction
- 1/2" IPS Connections
- Chrome handles
- 2.5 GPM at 80 PSI
- 1 per bar coded display box
- 24 per case

16-126 Shower Valve **48.86**

ADVANTAGE™
CAST BRASS WASHERLESS
CHROME PLATED
SINGLE HANDLE
TUB & SHOWER SET

LIMITED LIFETIME WARRANTY

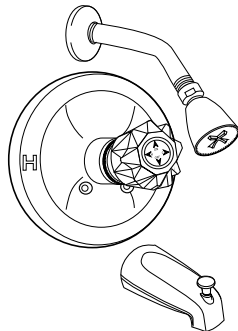

- Solid brass construction
- 1/2" IPS connections
- Acrylic handle
- 2.5 GPM at 80 PSI
- ISO 9002 certified
- 1 per bar coded display box
- 6 per case

17-380 Chrome Plated Tub & Shower Set **54.47**



PAY BY MAJOR CREDIT CARD
WHEN YOU PLACE YOUR ORDER
AND SAVE UP TO AN
ADDITIONAL 10%
OFF OUR ALREADY
INDUSTRY-LOW PRICES!!

ADVANTAGE™

ADVANTAGE™
CHROME PLATED CAST BRASS
COMPRESSION TWO HANDLE
TUB & SHOWER SET

LIMITED LIFETIME WARRANTY

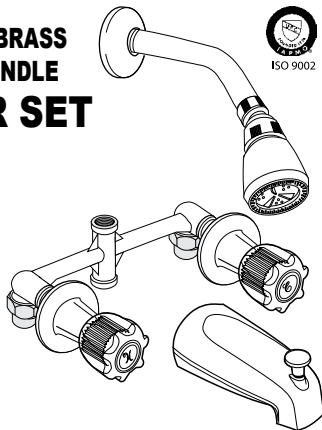

- Solid brass construction
- 1/2" IPS connections
- Acrylic handles
- Chrome trim
- 2.5 GPM at 80 PSI
- 1 per bar coded display box
- 6 per case

16-120 Tub & Shower Set **57.65**

ADVANTAGE™
CHROME PLATED CAST BRASS
THREE HANDLE
TUB & SHOWER SET

LIMITED LIFETIME WARRANTY

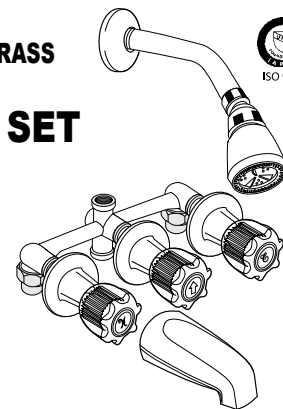

- Solid brass construction
- 1/2" IPS connections
- 8" centerset
- Acrylic handles
- 2.5 GPM at 80 PSI
- ISO 9002 certified
- UPC/ IAPMO approved
- 1 per bar coded display box
- 6 per case

16-118 Chrome Plated Compression Tub & Shower Set **75.48**
16-122 Chrome Plated Washerless Tub & Shower Set **NEW 85.94**

USE YOUR CREDIT CARD AT TIME OF PURCHASE AND SAVE 2% ON ALL ORDERS,
SAVE 5% ON ALL ORDERS OVER \$500 OR SAVE 10% ON ALL ORDERS OVER \$1000

DELTA KITCHEN FAUCETS



FAUCETS AND EXTERNAL TRIM



SP (100) (400)



CHROME PLATED CAST BRASS WASHERLESS SINGLE HANDLE KITCHEN FAUCET WITH SPRAY

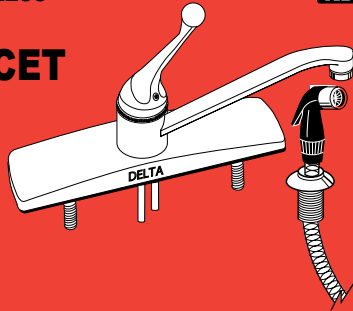

- Solid brass construction
- 8" centers
- Copper connections
- Chrome finish
- 2.0 GPM at 60 PSI
- 1 per bar coded display box

10-600 Kitchen Faucet less Spray **84.55**
 10-601 Kitchen Faucet with Spray(shown) **103.98**



SP (100-WF) (400-WF)



CHROME PLATED CAST BRASS WASHERLESS SINGLE HANDLE KITCHEN FAUCET

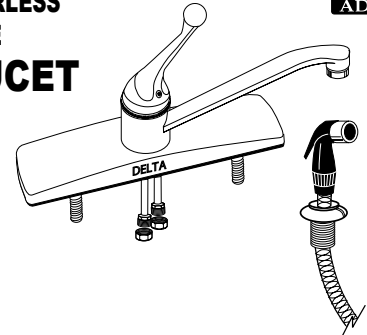

- Solid brass construction
- 8" centers
- 1/2" IPS connections
- Chrome finish
- 2.0 GPM at 60 PSI
- 1 per bar coded display box
- 12 per case

10-603 Kitchen Faucet less Spray **87.14**
 10-605 Kitchen Faucet with Spray(shown) **106.43**

Genuine Delta Parts mean no expensive call backs

Hole punched for pegboard storage

Reorder Item#

Ziplock clear polybag for easy access



Detailed illustration clearly defining kit contents

Barcoding means you'll receive the correct item.

WHY HODES CO?

BECAUSE LIFE'S TOO SHORT TO BE ANYTHING BUT SATISFIED
 ISO 9001:2000 QUALITY SYSTEM CERTIFIED



SP (140-WF) (440-WF)



CHROME PLATED SINGLE HANDLE KITCHEN FAUCET WITH SPRAY

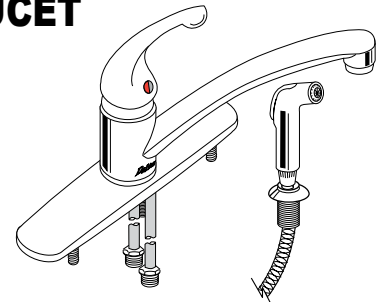

- Swivel spout
- Solid brass construction
- 9" spout reaches 6" in height
- 2.2 GPM
- 3/8" OD or 1/2" IPS inlets
- 1" maximum deck thickness
- 1 per bar coded display box

10-664 Kitchen Faucet less Spray **100.86**
 10-663 Kitchen Faucet with Spray(shown) **124.67**



SP (2102) (2402-TP)

CHROME PLATED CAST BRASS WASHERLESS TWO HANDLE KITCHEN FAUCET WITH SPRAY

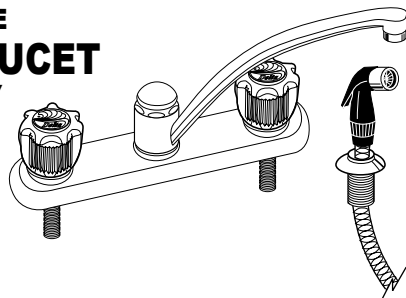

- Solid brass construction
- 8" centers
- 1/2" IPS connections
- Acrylic handles
- Chrome finish
- 2.0 GPM at 60 PSI
- 1 per bar coded display box

10-610 Kitchen Faucet less Spray **65.01**
 10-611 Kitchen Faucet with Spray(shown) **84.34**



SP (2170)

CHROME/WHITE CAST BRASS WASHERLESS TWO HANDLE BAR FAUCET

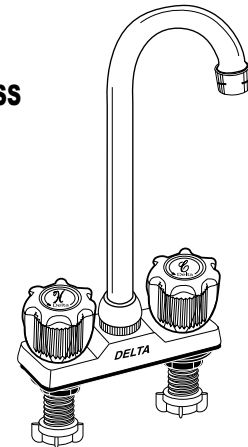

- Solid brass construction
- 4" centers
- 1/2" IPS connections
- Acrylic handles
- Chrome finish
- 10-5/8" high tubular spout
- 2.0 GPM at 60 PSI
- 1 per bar coded display box

10-662 Bar Faucet **103.43**

**USE YOUR CREDIT CARD AT TIME OF PURCHASE AND SAVE 2% ON ALL ORDERS,
 SAVE 5% ON ALL ORDERS OVER \$500 OR SAVE 10% ON ALL ORDERS OVER \$1000**

FAX 1-800-982-5934 www.HODESCO.com PHONE 1-800-777-6500
 203

DELTA



DELTA LAVATORY FAUCETS



(520-MPU)

**CHROME PLATED
CAST BRASS WASHERLESS
SINGLE LEVER HANDLE
LAVATORY FAUCET
WITH BRASS
POP-UP ASSEMBLY**

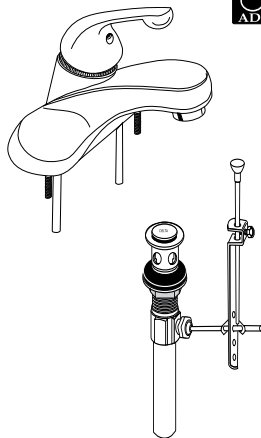

- Solid brass construction
- 4" centers
- Copper connections
- Chrome trim
- 2.0 GPM at 80 PSI
- Includes brass pop-up assembly
- 1 per bar coded display box

10-628 Lavatory Faucet with Brass Pop-Up..... **104.06**



(500-WF) (520-WFMPU)

**CHROME PLATED
CAST BRASS WASHERLESS
SINGLE LEVER HANDLE
LAVATORY FAUCET
WITH BRASS POP-UP ASSEMBLY**

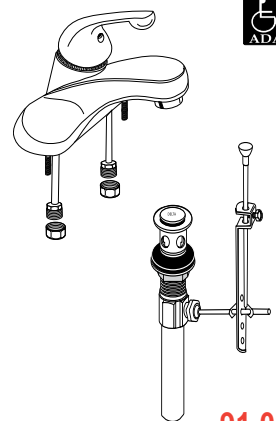

- Solid brass construction
- 4" centers
- 1/2" IPS connections
- Chrome trim
- 2.0 GPM at 80 PSI
- Includes pop-up assembly
- 1 per bar coded display box 12 per case

10-608 Lavatory Faucet less Pop-Up..... **91.03**
10-612 Lavatory Faucet with Pop-Up(shown) **103.20**



(522-MPU)

**CHROME PLATED
CAST BRASS WASHERLESS
SINGLE KNOB HANDLE
LAVATORY FAUCET
WITH BRASS POP-UP ASSEMBLY**

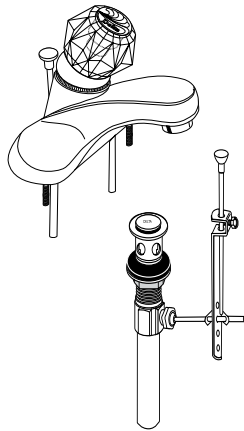

- Solid brass construction
- 4" centers
- Copper connections
- Acrylic handle
- Chrome trim
- 2.0 GPM at 80 PSI
- Includes brass pop-up assembly
- 1 per bar coded display box

10-620 Lavatory Faucet with Brass Pop-Up..... **98.84**



(2502) (2522-MPU)

**CHROME PLATED
CAST BRASS WASHERLESS
TWO HANDLE
LAVATORY FAUCET**

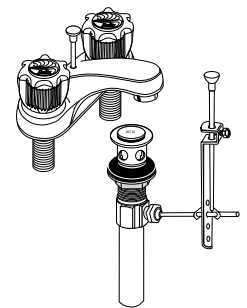

- Solid brass construction
- 4" centerset
- 1/2" IPS connections
- Acrylic handles
- Chrome trim
- 2.0 GPM at 80 PSI
- Red/blue handle indicators
- 1 per bar coded display box

10-625 Lavatory Faucet less Brass Pop-Up..... **55.91**
10-626 Lavatory Faucet with Brass Pop-Up(shown) **75.43**



(2521-LHP)

**CHROME PLATED
CAST BRASS WASHERLESS
LESS TWO HANDLE
LAVATORY FAUCET
WITH BRASS POP-UP ASSEMBLY**

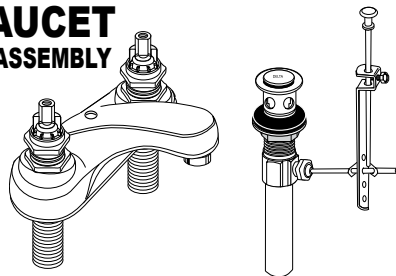

- Solid brass construction
- 4" centers
- 1/2" IPS connections
- Chrome trim
- 2.0 GPM at 80 PSI
- 1 per bar coded display box
- 6 per case

Must order handle bases and accents to complete faucet

10-623 Lavatory LHP Faucet with Brass Pop-Up..... **74.12**



(H22)

**HANDLE
BASE**

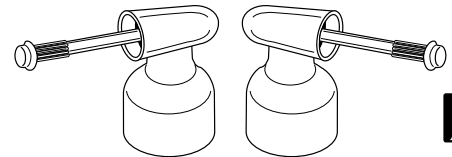

29-630 Chrome Handle Bases..... **30.62**



(A22)

**LAVATORY
HANDLE
ACCENTS**



• Chrome
• Includes pop-up knob and handle inserts
29-636 Genuine Chrome Handle Accents (3 pc set) **15.46**

**USE YOUR CREDIT CARD AT TIME OF PURCHASE AND SAVE 2% ON ALL ORDERS,
SAVE 5% ON ALL ORDERS OVER \$500 OR SAVE 10% ON ALL ORDERS OVER \$1000**

FAX 1-800-982-5934 www.HODESCO.com PHONE 1-800-777-6500
204 **HODESCO** PREFERRED PLUMBING PRODUCTS



HOSE WASHER CARDS!

Actual Size Of Card



“A really dynamic response...ten times more effective than stickers or business cards” – Ohio

“I put 25 in my local barbershop and got 3 jobs within 2 weeks from new customers – all from these cards” – Nebraska

We have sold this copyrighted sales plan to plumbing shops since 1943. Repeat order after repeat order convince us that it is a unique and effective way to make your business known to commercial and residential customers.

The tires on the card are hose washers that are easily removed. Your company name, phone number and service description is printed just the way you want it, and will be remembered when they need service.

Send us your letterhead or business card, or draw us a diagram of what you want. Printing must be limited to the truck panel as shown. **Two color printing included!** Set yourself apart today!

95-501 Box of 1,000 **703.13**

PLEASE ALLOW 3 WEEKS FOR DELIVERY

USE YOUR CREDIT CARD AT TIME OF PURCHASE AND SAVE 2% ON ALL ORDERS, SAVE 5% ON ALL ORDERS OVER \$500 OR SAVE 10% ON ALL ORDERS OVER \$1000

FAX 1-800-982-5934 **www.HODESCO.com** **PHONE 1-800-777-6500**





(T13222) TRIM ONLY
(R10000) VALVE ONLY

**CHROME PLATED
PRESSURE BALANCED
CAST BRASS WASHERLESS
SINGLE HANDLE
SHOWER SET**

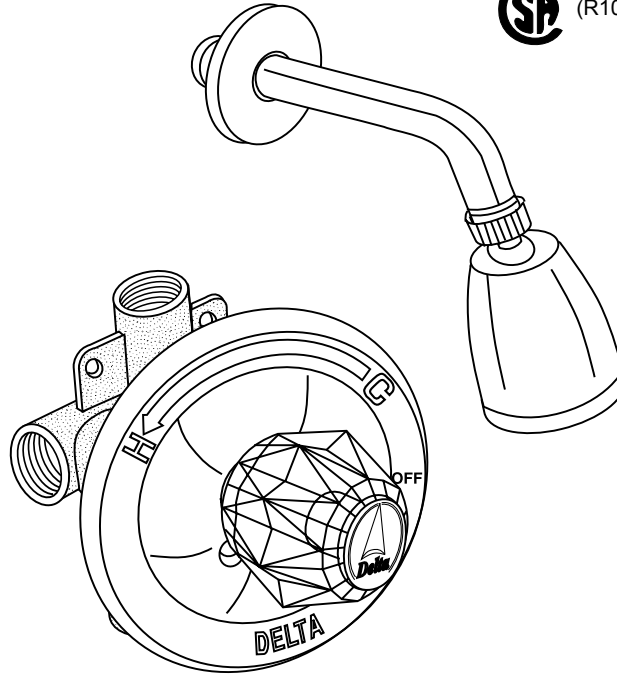

- Solid brass construction
- Scald-Guard® pressure balance mechanism
- Rotational limit stop
- 1/2" IPS connections
- Acrylic handle
- Chrome trim
- 2.5 GPM at 80 PSI
- 1 per box

10-648	Scald-Guard Shower Set (Complete Set).....	108.79
10-646	Shower Set (Trim Only).....	68.81
10-640	Scald-Guard (Valve Only).....	36.76



(T13422) TRIM ONLY
(R10000) VALVE ONLY

**CHROME PLATED
PRESSURE BALANCED
CAST BRASS WASHERLESS
SINGLE HANDLE
TUB & SHOWER SET**

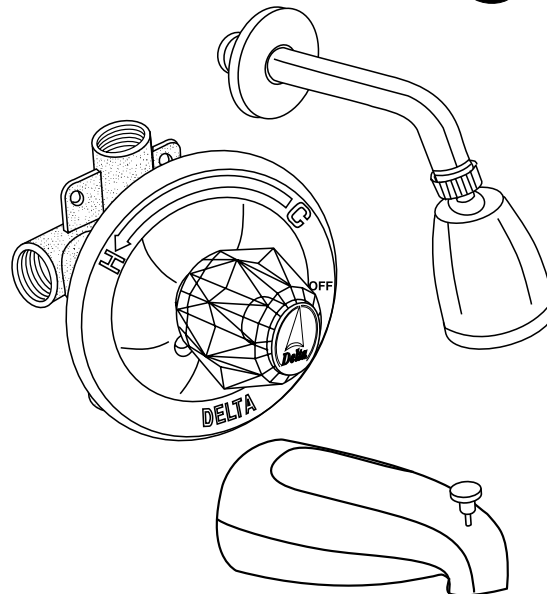

- Solid brass construction
- Scald-Guard® pressure balance mechanism
- Rotational limit stop
- 1/2" IPS connections
- Acrylic handle
- Chrome trim
- 2.5 GPM at 80 PSI
- 1 per box

10-644	Scald-Guard Tub and Shower Set (Complete Set).....	122.38
10-649	Tub and Shower Set (Trim Only).....	85.90
10-640	Scald-Guard (Valve Only).....	36.76

**USE YOUR CREDIT CARD AT TIME OF PURCHASE AND SAVE 2% ON ALL ORDERS,
SAVE 5% ON ALL ORDERS OVER \$500 OR SAVE 10% ON ALL ORDERS OVER \$1000**

GERBER KITCHEN & LAVATORY FAUCETS



FAUCETS AND EXTERNAL TRIM

GERBER (40-400-16) 
CHROME PLATED
CAST BRASS WASHERLESS HARDWATER™
SINGLE LOOP HANDLE
KITCHEN FAUCET
WITH SPRAY

WITH 16" COPPER SUPPLY CONNECTIONS!

- Solid brass construction
- 8" centers
- 3 or 4 hole installation
- 16" copper supply connections
- Loop handle Chrome finish
- Ceramaflo™ ceramic disc cartridge
- 2.0 GPM at 60 PSI 1 per box

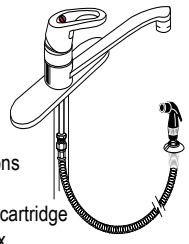

10-153 Kitchen Faucet with Spray **122.48**
 10-154 With IPS Connections **141.88**

GERBER (42-116)
CAST BRASS COMPRESSION
TWO HANDLE
KITCHEN FAUCET

- Solid brass construction
- 8" centers
- 1/2" IPS connections
- Chrome finish
- 8" cast brass spout
- 2.0 GPM at 60 PSI
- 1 per box

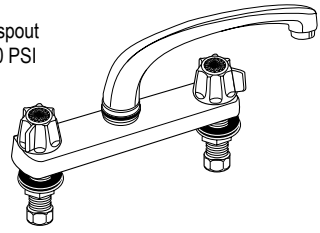

10-150 Kitchen Faucet **86.81**

GERBER (42-216)
CAST BRASS COMPRESSION
TWO HANDLE
KITCHEN FAUCET
WITH SPRAY

- Solid brass construction
- 8" centers
- 1/2" IPS connections
- Chrome finish
- 8" cast brass spout
- 2.0 GPM at 60 PSI
- Includes spray head & hose
- 1 per box

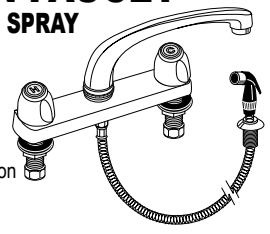

10-151 Kitchen Faucet with Spray **99.64**

GERBER (42-506)
CAST BRASS COMPRESSION
TWO HANDLE
KITCHEN FAUCET
WITH SPRAY

- Solid brass construction
- 8" centers
- 1/2" IPS connections
- Chrome finish
- 8" D tube spout
- 2.0 GPM at 60 PSI
- Includes spray head & hose
- 1 per box

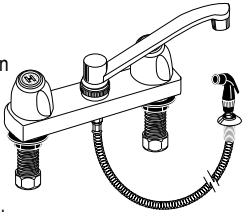

10-155 Kitchen Faucet with Spray **94.19**

GERBER (52-000) (52-010)
CHROME PLATED
CAST BRASS CERAMIC DISC
TWO HANDLE
KITCHEN FAUCET

- Solid brass construction
- 1/2" IPS connections
- Hardwater™ handles
- Chrome finish
- 8" centers
- 2.0 GPM at 60 PSI
- Ceramaflo™ ceramic disc cartridge
- Top mount 10" D tube spout
- 1 per box - 12 per carton

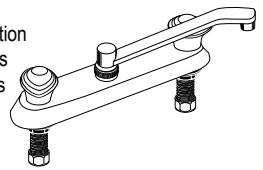

HARDWATER™
 10-157 Kitchen Faucet less Spray **NEW** ... **90.92**
 10-158 Kitchen Faucet with Spray **110.19**

HODES CO.
 PROFFERED PLUMBING PRODUCTS
Case Lot Pricing
 available at
www.HodesCo.com

GERBER (43-431)
CHROME PLATED
CAST BRASS COMPRESSION
TWO HANDLE
LAVATORY FAUCET
WITH BRASS POP-UP ASSEMBLY

- Solid brass construction
- 4" centers
- 1/2" IPS connections
- Chrome trim
- 1.7 GPM at 60 PSI
- Includes brass pop-up assembly

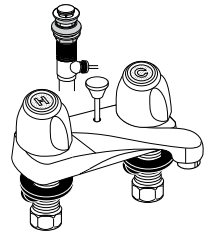

11-100 Lavatory Faucet with Brass Pop-Up. **86.43**

GERBER (40-524-16) 
CHROME PLATED
CAST BRASS WASHERLESS
HARDWATER™ SINGLE LOOP HANDLE
LAVATORY FAUCET
WITH BRASS POP-UP ASSEMBLY

WITH 16" COPPER SUPPLY CONNECTIONS!

- Solid brass construction
- 4" centers
- 16" copper supply connections
- Chrome trim
- Ceramaflo™ ceramic disc cartridge
- With temperature limit stop
- 1.7 GPM at 60 PSI
- 1 per box

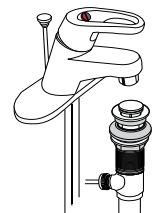

HARDWATER™
 11-102 Lavatory Faucet with Brass Pop-Up **115.88**

GERBER (53-120)
CHROME PLATED
CAST BRASS CERAMIC DISC
TWO HANDLE
LAVATORY FAUCET
WITH BRASS POP-UP ASSEMBLY

- Solid brass construction
- 1/2" IPS connections
- Hardwater™ handles
- Chrome finish
- 4" centerset
- 2.0 GPM at 60 PSI
- Ceramaflo™ ceramic disc cartridge
- Includes brass pop-up assembly
- 1 per box - 12 per carton

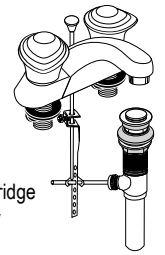

HARDWATER™
 11-108 Lavatory Faucet with Brass Pop-Up. **97.07**

USE YOUR CREDIT CARD AT TIME OF PURCHASE AND SAVE 2% ON ALL ORDERS, SAVE 5% ON ALL ORDERS OVER \$500 OR SAVE 10% ON ALL ORDERS OVER \$1000

FAX 1-800-982-5934 **www.HODES CO.com** **PHONE 1-800-777-6500**





**GERBER
WIDE SPREAD
LAVATORY FAUCET**

(43-071-61)
(44-051-61)

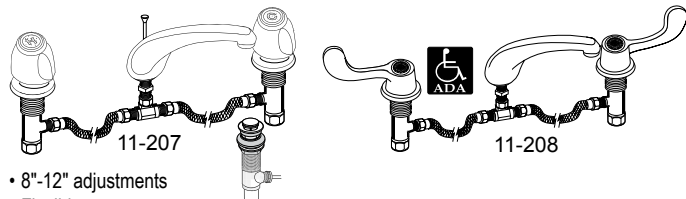

- 8"-12" adjustments
- Flexible connectors

11-207 Lavatory Faucet with Pop-Up **157.69**
11-208 Lavatory Faucet less Pop-Up with Handicap Blade Handles ... **237.55**

**GERBER
CHROME PLATED CAST BRASS
COMPRESSION TWO HANDLE
CORNER PATTERN SHOWER SET**

(47-150-83)

- Solid brass construction
- Union connections
- Sliding sleeve escutcheon
- Left and right hand built-in shower valve
- Priced per pair
- 1 set per box

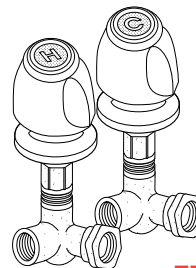

12-191 Corner Shower Valve **77.95**

**GERBER
CHROME PLATED CAST BRASS
COMPRESSION TWO HANDLE
8" CENTER TUB & SHOWER SET**

(48-720-83)

- Solid brass construction
- Sweat and IPS inlet combo connections
- Chrome finish
- Sliding sleeve escutcheon
- With ejector tee
- 1 per box

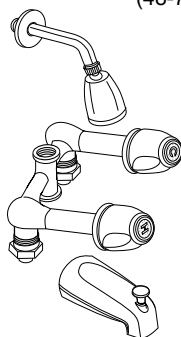

12-180 Tub & Shower Set **108.78**

**GERBER
CHROME PLATED CAST BRASS
WASHERLESS SINGLE LOOP HANDLE
TUB & SHOWER SET
SAFETEMP™ PRESSURE BALANCE VALVE**

(49-730-82)

- Solid brass construction
- 1/2" IPS connections
- Temperature limit stop
- Slip spout
- Chrome finish
- 2.5 GPM at 80 PSI
- 1 per box

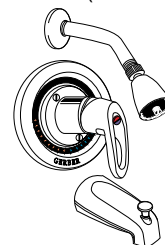

12-183 Safetemp™ Tub & Shower Set **141.42**

**GERBER
CHROME PLATED CAST BRASS
COMPRESSION TWO HANDLE
6" CENTER TUB FILLER SET**

(46-610-83)

- Solid brass construction
- Sweat and IPS inlet combo connections
- Chrome finish
- Sliding sleeve escutcheon
- Includes spout
- 6" center
- 1 per box

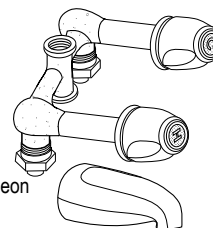

NEW STYLE

12-187 Tub Filler Set **81.57**

**GERBER
CHROME PLATED CAST BRASS
WASHERLESS HARDWATER™
SINGLE LOOP HANDLE
TUB & SHOWER SET
PRESSURE BALANCE VALVE**

(49-830-82)

- Solid brass construction
- 1/2" IPS connections
- Temperature limit stop
- Ceramaflow™ ceramic disc cartridge
- Volume control
- Slip spout
- Chrome finish
- 2.5 GPM at 80 PSI
- 1 per box

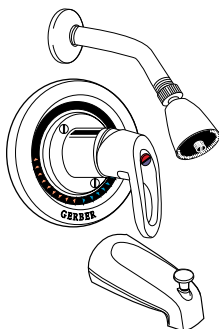

12-184 Hardwater™ Tub & Shower Set **221.26**

**GERBER
CHROME PLATED CAST BRASS
COMPRESSION TWO HANDLE
8 CENTER TUB & SHOWER SET**

(58-400)

- Ceramaflow ceramic disc cartridges
- Body cast of high copper content brass
- Sweat and IPS inlet combo connections
- Chrome finish
- Sliding sleeve escutcheon
- 8" center
- 1 per box



NEW

HARDWATER™

12-192 Tub Filler Set **118.01**

**GERBER
CHROME PLATED
CAST BRASS COMPRESSION
THREE HANDLE
TUB & SHOWER SET**

(48-030-83)

- Solid brass construction
- Sweat and IPS inlet combo connections
- Chrome finish 8" centers
- Sliding sleeve escutcheon
- 2.5 GPM at 80 PSI
- 1 per box

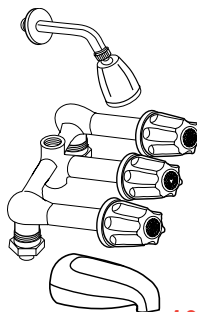

12-181 Tub & Shower Set **108.78**
12-189 With Threaded Escutcheon & Hardwater Handles **141.61**

**GERBER
CHROME PLATED
CAST BRASS COMPRESSION
THREE HANDLE TUB & SHOWER SET**

(47-130-83)

- Solid brass construction
- Sweat and IPS inlet combo connections
- Chrome finish
- Sliding sleeve escutcheon
- 11" centers
- 2.5 GPM at 80 PSI
- 1 per box

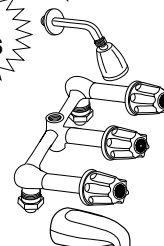

12-102 Tub & Shower Set **144.32**

**USE YOUR CREDIT CARD AT TIME OF PURCHASE AND SAVE 2% ON ALL ORDERS,
SAVE 5% ON ALL ORDERS OVER \$500 OR SAVE 10% ON ALL ORDERS OVER \$1000**

FAX 1-800-982-5934 www.HODESCO.com PHONE 1-800-777-6500
208 **HODESCO** PREFERRED PLUMBING PRODUCTS

MOEN FAUCETS



FAUCETS AND EXTERNAL TRIM

MOEN® OLD # NEW #
(7531) (07425)

CHROME PLATED CAST BRASS WASHERLESS SINGLE LEVER KITCHEN FAUCET

- Solid brass construction
- 8" centerset
- 1/2" IPS connections
- Lever Handle
- Chrome finish
- 2.2 GPM at 60 PSI

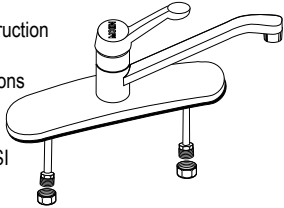

CHATEAU

10-834 Boxed without Spray **89.83**

MOEN® (07430)

CHROME PLATED CAST BRASS WASHERLESS SINGLE LEVER KITCHEN FAUCET WITH SPRAY

- Solid brass construction
- 8" centerset
- 1/2" IPS Connections
- Lever Handle
- Chrome finish
- 2.2 GPM at 60 PSI

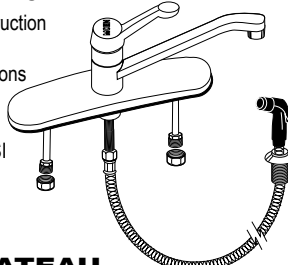

CHATEAU

10-803 Boxed with Spray **113.01**

MOEN® (7910)

CHROME PLATED CAST BRASS WASHERLESS TWO HANDLE KITCHEN FAUCET WITH SPRAY

- Solid brass construction
- 8" centerset
- 1/2" IPS connections
- Chrome finish
- 2.2 GPM at 60 PSI

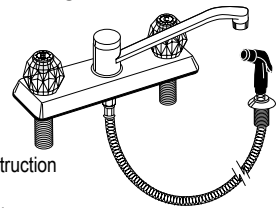

CHATEAU

10-810 Boxed with Spray **111.87**

MOEN® (67900)

CHROME PLATED CAST BRASS WASHERLESS TWO HANDLE KITCHEN FAUCET

- Solid brass construction
- 8" centerset
- 1/2" IPS connections
- Chrome finish
- 2.2 GPM at 60 PSI

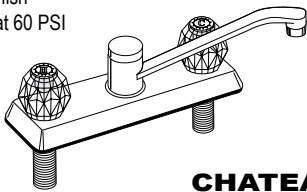

CHATEAU

10-808 Boxed without Spray **84.97**

MOEN® (4621) (64620)

CHROME PLATED CAST BRASS WASHERLESS SINGLE HANDLE LAVATORY FAUCET WITH BRASS POP-UP

- Solid brass construction
- 4" centerset
- 1/2" IPS connections
- Chrome finish
- Clear acrylic handle
- 2.0 GPM at 60 PSI

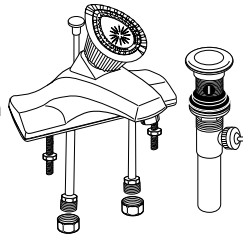

10-815 Boxed IPS with Brass Pop-Up . . . **115.64**

MOEN® (4920) (64919)

CHROME PLATED CAST BRASS WASHERLESS TWO HANDLE LAVATORY FAUCET WITH BRASS POP-UP

- Solid brass construction
- 4" centerset
- 1/2" IPS connections
- Chrome finish
- Clear acrylic handles
- 2.0 GPM at 60 PSI

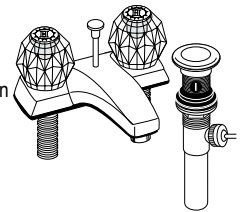

10-835 Boxed with Brass Pop-Up **89.03**

MOEN® (L2353)

POSI-TEMP TUB & SHOWER FAUCET

- Solid brass construction
- Pressure balance
- 4 Port
- Cycling valve
- 1/2" Sweat connection
- Chrome finish
- 1 per box-6 per case

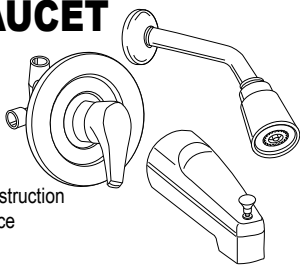

CHATEAU

10-833 Boxed Posi-Temp Tub & Shower Faucet . **121.48**

MOEN® (2995)

TWO HANDLE TUB & SHOWER TRIM

- Standard non-pressure balancing valve
- Acrylic knob handles
- 5-1/2" tub filler spout



CHATEAU

10-870 Boxed Posi-Temp Tub & Shower Faucet . **133.84**

MOEN® (2353)

POSI-TEMP ONE HANDLE VALVE TUB & SHOWER TRIM

- Single handle Posi temp valve and tub and shower trim
- Pressure balancing cycling valve
- Acrylic knob handles
- 4 port
- Adjustable temperature limit stop



CHATEAU

10-871 Boxed Posi-Temp Tub & Shower Faucet . **125.94**

USE YOUR CREDIT CARD AT TIME OF PURCHASE AND SAVE 2% ON ALL ORDERS, SAVE 5% ON ALL ORDERS OVER \$500 OR SAVE 10% ON ALL ORDERS OVER \$1000

FAX 1-800-982-5934

www.HODES CO.com



PHONE 1-800-777-6500



Central Brass® (1177-A)
**CHROME PLATED CAST BRASS
 COMPRESSION TWO HANDLE
 LEDGE BACK
 LAVATORY FAUCET**

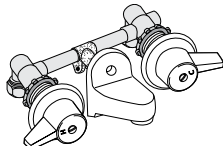

- Solid brass construction
- 1/2" IPS connections
- 4-1/2" to 6" adjustable centers
- Aerator
- Chrome finish
- Fits any ledge back centerset
- 2.0 GPM at 60 PSI
- 1 per box

11-205 Ledge Back Faucet..... **133.76**

Central Brass® (T30128)
**CHROME PLATED CAST BRASS
 COMPRESSION TWO HANDLE
 WALL FAUCET**

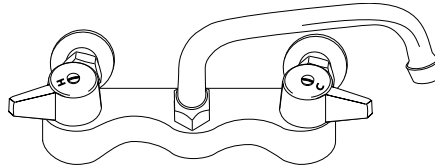

- Metal lever handles
- 8" brass spout
- Piston cartridge
- 7-7/8" - 8-1/2" centers

10-209 Genuine Wall Mount Faucet-Chrome **122.56**

INDIANA BRASS (LB777)
**CHROME PLATED CAST BRASS
 COMPRESSION TWO HANDLE
 LAVATORY FAUCET
 POP-UP ASSEMBLY**

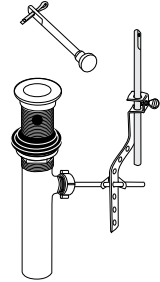

- Solid brass construction
- Chrome finish
- 4-1/2" to 6" adjustable centers
- Fits any ledge back centerset
- Fits 11-205
- 1 per box

11-204 Pop-Up Assembly Only..... **33.94**

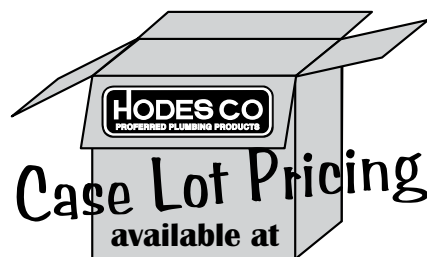

www.HodesCo.com

T&S (B0155)
**ADD-ON FAUCET FOR
 PRE-RINSE UNIT**

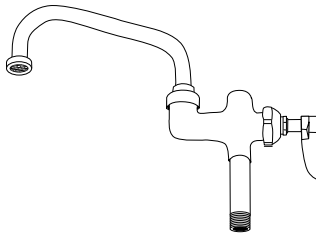

- Adds swinging nozzle to pre-rinse units
- 6" (152mm) nozzle
- Includes 3" nipple as shown (000358-40)

10-364 Genuine Add-On Faucet **99.85**

T&S (B0100)
 (B-0044-H)
**PRE-RINSE SPRAY WITH
 FLEXIBLE STAINLESS STEEL
 HOSE**

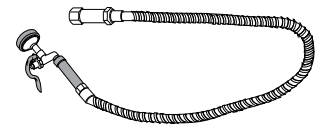

- Designed for heavy duty use in industrial kitchens
- Automatic shut-off valve with spray head (B-0107)
- 3 ft (914mm) flexible stainless steel hose (B-0044-H)
- 1/2" IPS male inlet
- 48" (1219mm) overall length of unit

10-355 Genuine Pre-Rinse Spray **166.43**

10-331 Genuine 44" Hose Less Spray..... **75.78**

T&S (B0113)
PRE-RINSE UNIT

- 4" (102mm) center deck faucet (002824-40)
- Under sink 1/4" IPS tailpieces
- Approx. 48" (1219mm) high
- 15" (381mm) overhang
- 9" (229mm) clearance
- 24" (610mm) riser model 000372-40
- Includes spray valve and flexible stainless steel hose

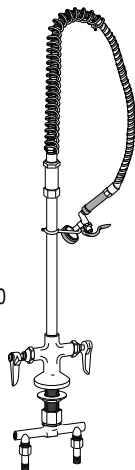

10-381 Genuine Pre-Rinse Unit..... **334.58**

T&S (B0133)
PRE-RINSE UNIT

- 8" (203mm) center wall mounted faucet (002832-40)
- 1/2" IPS female eccentric flanged inlets (00AA)
- 34" (863mm) high
- 15" (457mm) overhang
- 18" (457mm) riser
- Includes spray valve and flexible stainless steel hose

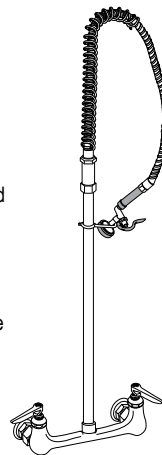

10-338 Genuine Pre-Rinse Unit..... **446.13**

T&S (B0107)
PRE-RINSE SPRAY VALVE

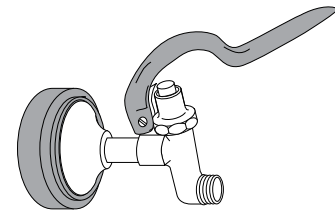

- Used on most T&S pre-rinse units
- Connects directly to T&S flexible stainless steel hose or Roto-Flex handle assembly
- Designed for heavy use in industrial kitchens
- Provides high pressure spray when handle is pressed
- Shuts off when handle is released

10-369 Genuine Spray Assembly **88.91**

**USE YOUR CREDIT CARD AT TIME OF PURCHASE AND SAVE 2% ON ALL ORDERS,
 SAVE 5% ON ALL ORDERS OVER \$500 OR SAVE 10% ON ALL ORDERS OVER \$1000**

FAX 1-800-982-5934 www.HODES CO.com PHONE 1-800-777-6500
 210



ADD-A-SHOWERS



**FAUCETS AND
EXTERNAL TRIM**

**CHROME PLATED CAST BRASS
ADD-A-Shower
FOR BUILT-IN TUBS**

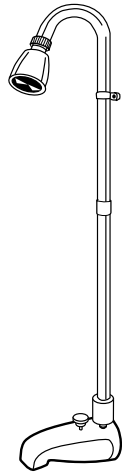

3/8" FIP RISER
CONNECTION

- Solid brass construction
- Brass Riser - 50"
- Chrome Plated Showerhead & Spout
- 3/4" or 3/8" FIP connection
- 1 per bar coded display box

14-103 Add-A-Shower Unit..... **94.78**

**CHROME PLATED BRASS
ADD-A-Shower
FRAME COMPLETE**

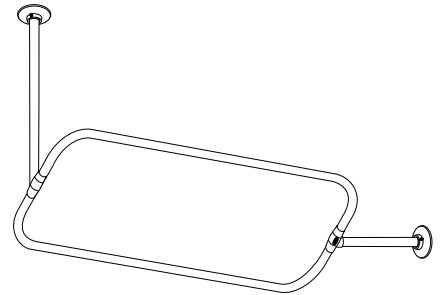

- 24" x 41"
- 10" long wall support
- Chrome finish
- 1 per bar coded display box

14-109 Add-A-Shower Frame Complete..... **65.52**

**CHROME PLATED
CAST BRASS COMPRESSION
TWO HANDLE
ADD-A-Shower
WITH HIGH CODE SPOUT**

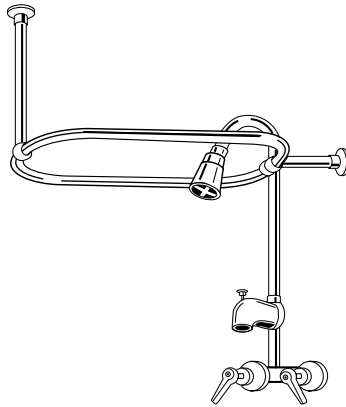

- 3-3/8" centers
- Diverter spout 4" above valve
- Riser - 56"
- 24" x 42" frame
- 10" wall support
- 30" ceiling support
- 2.5 GPM at 80 PSI
- 1 per bar coded display box

14-108 High Code Spout Add-A-Shower..... **334.65**

**CHROME PLATED
CAST BRASS COMPRESSION
TWO HANDLE
ADD-A-Shower
COMPLETE
FOR LEG TUBS**

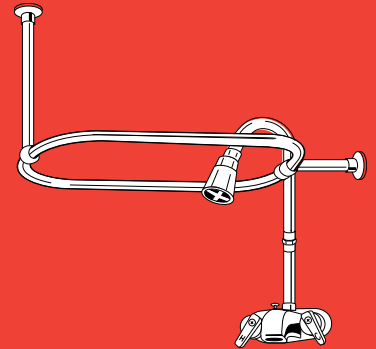

- Solid brass construction
- 3-3/8" centers
- 3/8" x 60" CP brass riser
- 24" x 42" curtain frame
- 10" Wall and 30" Ceiling supports
- Chrome finish
- 2.5 GPM at 80 PSI
- 1 per bar coded display box

14-405 Add-A-Shower Complete..... **122.57**

**CHROME PLATED
CAST BRASS WASHERLESS
TWO HANDLE
ADD-A-Shower
VALVE**

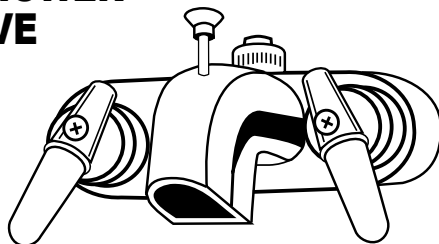

- 3-3/8" centers
- 3/8" FIP coupling connection for riser
- Solid brass construction
- Chrome finish
- 1 per bar coded display box

19-625 Washerless Add-A-Shower Valve..... **89.26**

**CHROME PLATED ALUMINUM
FIT-ALL CEILING
SUPPORT
WITH FLANGE**

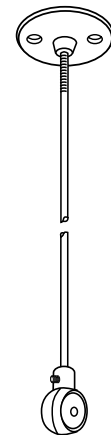

- Flange included
- 6" to 36" adjustable
- For Add-A-Shower frame
- 1 per bar coded display box

13-130 Ceiling Support..... **10.53**

**USE YOUR CREDIT CARD AT TIME OF PURCHASE AND SAVE 2% ON ALL ORDERS,
SAVE 5% ON ALL ORDERS OVER \$500 OR SAVE 10% ON ALL ORDERS OVER \$1000**

FAX 1-800-982-5934 www.HODES CO.com PHONE 1-800-777-6500
PROFFERED PLUMBING PRODUCTS **211**

ADD-A-SHOWE



ADVANTAGE™
CHROME PLATED
CAST BRASS COMPRESSION
TWO HANDLE
LAUNDRY TUB FAUCET

LIMITED LIFETIME WARRANTY

- Solid brass construction
- 4" centers
- Hose end spout
- Chrome finish
- 1 per bar coded display box
- 6 per case

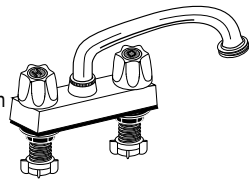

17-533 Laundry Faucet **29.50**

ADVANTAGE™
CAST BRASS COMPRESSION
TWO HANDLE
TOP SUPPLY
LAUNDRY FAUCET

LIMITED LIFETIME WARRANTY

- Solid brass construction
- 3/4" male hose end
- 6" brass spout
- 1/2" IPS union connections
- 2-way brackets for wall or tub mount installations
- 1 per bar coded display box
- 6 per case

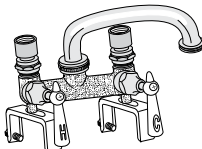

17-530 Top Supply Laundry Faucet **38.87**

GERBER (59-980)
CAST BRASS COMPRESSION
TWO HANDLE
LAUNDRY FAUCET

- Cast brass underbody
- heavy chrome plated brass shell
- 6" swing spout
- 4" centers for mounting
- Ceramic disc cartridge
- 2.2 gpm @ 60 psi
- 1/2" NPSM supply connections w/brass coupling nuts
- Gerber Hardwater handles



NEW

15-138 Laundry Faucet **73.23**

ADVANTAGE™
CAST BRASS
LAUNDRY VALVE



- Male hose outlet
- Convenient supply to machine
- Preserves hoses
- Hot and cold one motion shut-off
- Easy to install
- 1 per box

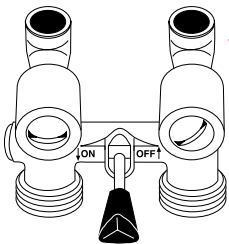

COMPARE WATTS

49-110 ADVANTAGE 1/2" Sweat Laundry Valve . **29.39**

WATTS REGULATOR
CAST BRASS
LAUNDRY VALVE



- Male hose outlet
- Convenient supply to machine
- Preserves hoses
- Hot and cold one motion shut-off
- Easy to install
- 1 per box

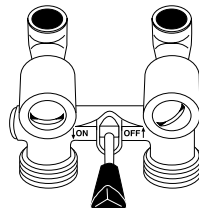

44-110 WATTS 1/2" Sweat Laundry Valve . . . **48.87**

44-111 WATTS 1/2" IPS Laundry Valve . . . **48.87**

GERBER (49-530)
CAST BRASS COMPRESSION
TWO HANDLE
TOP SUPPLY LAUNDRY FAUCET

- 3-1/2" centers
- Clamp-on style
- Chrome lever handles
- 1/2" IPS union inlet
- Hose end spout
- 1 per box

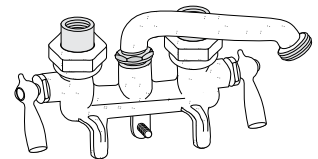

15-131 Top Supply Laundry Faucet **63.04**

GERBER (49-234)
CHROME PLATED
CAST BRASS COMPRESSION
TWO HANDLE
LAUNDRY TUB FAUCET

- 4" centers
- IPS connections
- Hose end connection
- 8" swing spout
- Chrome finish
- 1 per box

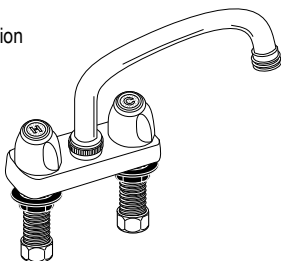

15-132 Laundry Tub Faucet **83.15**

GERBER (49-531) (49-536)
CAST BRASS COMPRESSION TWO HANDLE
TOP SUPPLY LAUNDRY FAUCET
DIRECT SWEAT

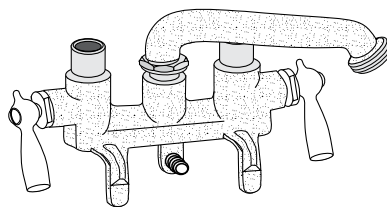

15-133 Top Supply Faucet w/ Hose End Spout. . . **55.55**

15-137 Top Supply Faucet w/ Plain Spout . . . **55.55**

MUSTEE
LAUNDRY TRAY
MOUNTING BLOCK

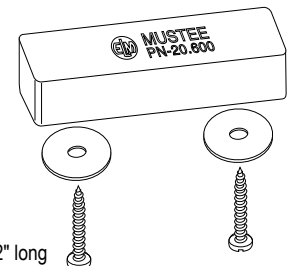

- 1-1/4" wide x 5-1/2" long
- 1-3/8" deep
- Reinforced white plastic
- Used with overhead faucet supply

53-620 Laundry Block. **5.13**

USE YOUR CREDIT CARD AT TIME OF PURCHASE AND SAVE 2% ON ALL ORDERS, SAVE 5% ON ALL ORDERS OVER \$500 OR SAVE 10% ON ALL ORDERS OVER \$1000

SPECIALTY FAUCETS



FAUCETS AND EXTERNAL TRIM

ADVANTAGE™

LIMITED LIFETIME WARRANTY

CHROME PLATED CAST BRASS COMPRESSION TWO HANDLE WALL MOUNT SINK FAUCET

- Solid brass construction
- 8" centers
- 1/2" FIP connections
- Includes soap dish
- 2.0 GPM at 60 PSI
- 1 per bar coded display box
- 12 per case

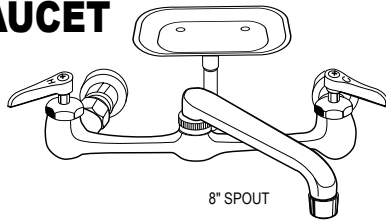

16-121 Brass Sink Faucet with 8" Cast Spout **65.99**

ADVANTAGE™

LIMITED LIFETIME WARRANTY

CHROME PLATED CAST BRASS COMPRESSION TWO HANDLE ADJUSTABLE WALL MOUNT SINK FAUCET

- Solid brass construction
- 12" tubular swing spout
- 7" to 9" adjustable centers
- 1/2" FIP connections
- Includes soap dish
- 2.0 GPM at 60 PSI
- Meets minimum low lead requirements
- 1 per bar coded display box
- 12 per case

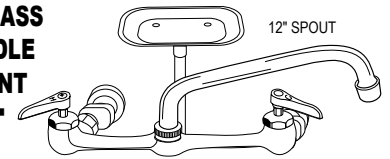

16-145 Brass Adjustable Sink Faucet **72.23**

Central Brass® THE "EXTRA" FAUCET

(281-A)

- Instant hot water
- Filtered water
- Bar sinks
- Other uses

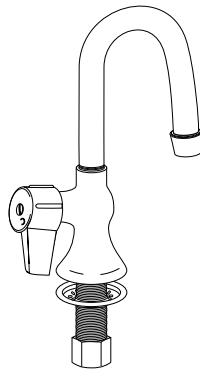

11-202 7" Tall with 2.5 Gal Aerator **100.23**

ADVANTAGE™

LIMITED LIFETIME WARRANTY

CHROME PLATED CAST BRASS COMPRESSION TWO HANDLE WALL MOUNT SINK FAUCET

- Solid brass construction
- 12" tubular swing spout
- 8" centers
- 1/2" FIP connections
- Includes soap dish
- 2.0 GPM at 60 PSI
- Meets minimum low lead requirements
- 1 per bar coded display box
- 12 per case

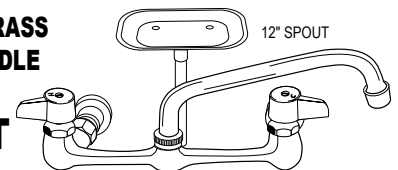

NEW

16-153 Brass Sink Faucet **35.34**

ADVANTAGE™

CHROME PLATED CAST BRASS DRINKING WATER FAUCET WITH GOOSENECK SPOUT

- Touch release or continuous flow
- 1/4" compression inlet
- Meets minimum low lead requirements
- 1 per bar coded display box

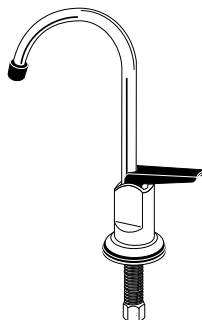

11-195 Drinking Water Faucet **11.41**



SINGLE PANTRY FAUCET

(B-0306)

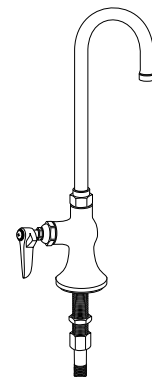

10-349 Swivel Spout (B0306) **108.80**

ADVANTAGE™

LIMITED LIFETIME WARRANTY

CHROME PLATED CAST BRASS "O" PATTERN BATH FAUCET

- Solid brass construction
- Chrome finish
- 3-3/8" centers
- Renewable seats (Hodes Co. Item # 27-372)
- 1 per bar coded display box

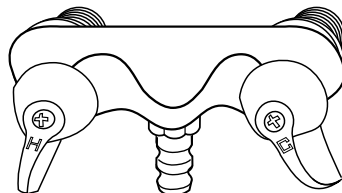

17-140 Bath Faucet **23.94**

ADVANTAGE™

LIMITED LIFETIME WARRANTY

SATIN CHROME PLATED CAST BRASS COMPRESSION TWO HANDLE INDUSTRIAL SHOWER FAUCET

- Solid brass construction
- Satin chrome plated
- 1/2" IPS union connection
- Self-cleaning showerhead
- Includes soap dish
- 2.5 GPM at 60 PSI
- 1 per bar coded display box

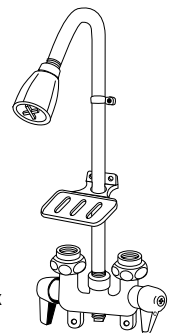

17-100 Industrial Shower Faucet **43.99**

USE YOUR CREDIT CARD AT TIME OF PURCHASE AND SAVE 2% ON ALL ORDERS, SAVE 5% ON ALL ORDERS OVER \$500 OR SAVE 10% ON ALL ORDERS OVER \$1000

FAX
1-800-982-5934

www. **HODES CO.** .com
PROFFERED PLUMBING PRODUCTS

PHONE
1-800-777-6500
213

SPECIALTY FAUCETS



ADVANTAGE™



CHROME PLATED CAST BRASS SINGLE BASIN FAUCET

- With aerator
- Solid brass construction
- Chrome finish
- Replaceable brass stem & seat
- Self-closing handle
- NSF certified
- 1 per bar coded display box

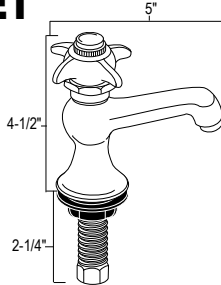

17-214 Single Basin Faucet **23.61**

ADVANTAGE™

CHROME PLATED CAST BRASS BASIN FAUCETS WITH RENEWABLE SEATS

- Renewable seats
- Priced per pair
- Cross handles
- Hot and cold index buttons
- Meets minimum low lead requirements
- 1 pair per bar coded display box

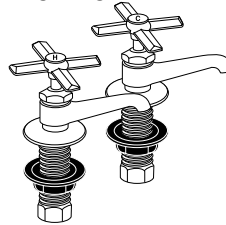

17-212 Pair of Basin Faucets **23.61**

ADVANTAGE™

CHROME PLATED CAST BRASS HEAVY PATTERN BASIN FAUCET

- With aerator
- Renewable seats
- Priced per pair
- Cross handles
- Hot and cold index buttons
- Meets minimum low lead requirements
- 1 pair per bar coded display box

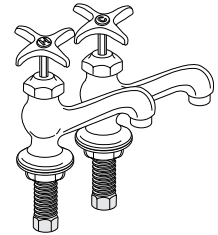

11-216 Pair of Cross Handle Basin Faucets ... **64.67**

ADVANTAGE™



HEAVY DUTY CHROME PLATED CAST BRASS BUBBLER FAUCET

- Solid brass construction
- Chrome plated
- 3/8" FIP inlet
- Includes bubbler cartridge
- NSF certified
- 1 per bar coded display box
- 100 per case

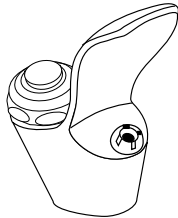

24-900 Bubbler Faucet **41.20**



PAY BY MAJOR CREDIT CARD WHEN YOU PLACE YOUR ORDER AND SAVE UP TO AN ADDITIONAL 10% OFF OUR ALREADY INDUSTRY-LOW PRICES!!

Central Brass® (360)
CHROME PLATED BUBBLER HEAD

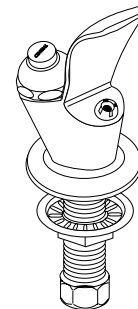

10-312 Bubbler Head with 1/2" Shank... **135.23**

SPECIALTY FAUCETS

Central Brass® (355-A)
"SLOW CLOSING" BASIN COCK

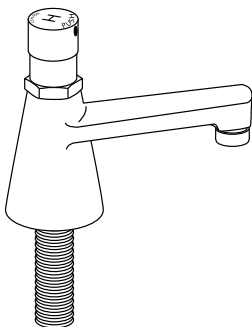

10-703 Basin Cock with Hot Index Button **111.47**

ELKAY® (92715C)
PROJECTOR

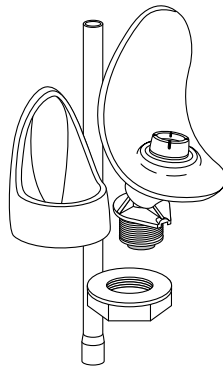

24-360 Elkay Kit (92715C) **26.01**

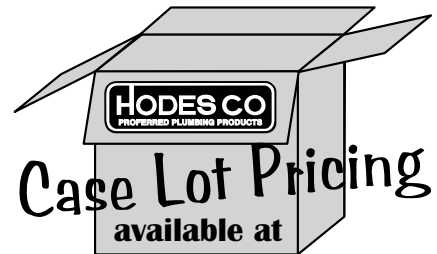

www.HodesCo.com

USE YOUR CREDIT CARD AT TIME OF PURCHASE AND SAVE 2% ON ALL ORDERS, SAVE 5% ON ALL ORDERS OVER \$500 OR SAVE 10% ON ALL ORDERS OVER \$1000

FAX 1-800-982-5934 www.HODESCO.com PHONE 1-800-777-6500
214



COMMERCIAL DRAINS



**FAUCETS AND
EXTERNAL TRIM**

ADVANTAGE™

(FRANKLIN# 100-1000)
(T&S B-3920)



3" SINK OPENING
X

**1-1/2" DRAIN OPENING
HEAVY DUTY COMMERCIAL
LEVER WASTE**

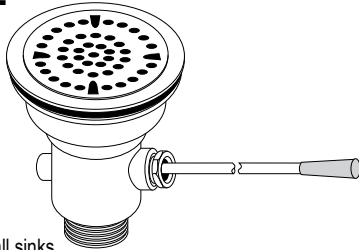

- Heavy nickel plated bronze body
- Stainless steel strainer and flange
- Counter sunk flange will fit virtually all sinks
- 2" male outside threads
- 1-1/2" female inside threads

55-728 Genuine Advantage Lever Waste **69.61**

ADVANTAGE™

(FRANKLIN# 100-1034)
(T&S# B-3921)



3" SINK OPENING
X

**2" DRAIN OPENING
HEAVY DUTY COMMERCIAL
LEVER WASTE**

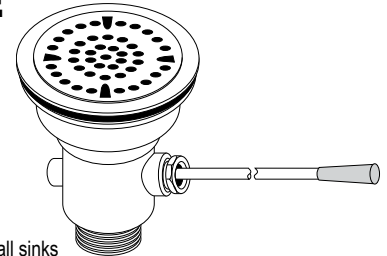

- Heavy nickel plated bronze body
- Stainless steel strainer and flange
- Counter sunk flange will fit virtually all sinks

55-729 Genuine Advantage Lever Waste **69.61**

ADVANTAGE™

(FRANKLIN# 100-1012)
(T&S# B-3922)



3-1/2" SINK OPENING
X

**1-1/2" DRAIN OUTLET
HEAVY DUTY COMMERCIAL
LEVER WASTE**

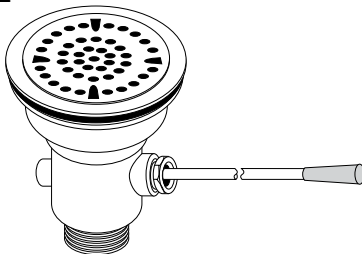

- Heavy nickel plated bronze body
- Stainless steel strainer and flange
- Counter sunk flange will fit virtually all sinks

55-730 Genuine Advantage Lever Wastes **69.61**

ADVANTAGE™

(FRANKLIN# 100-1035)
(T&S# B-3923)



3-1/2" SINK OPENING
X

**2" DRAIN OUTLET
HEAVY DUTY COMMERCIAL
LEVER WASTE**

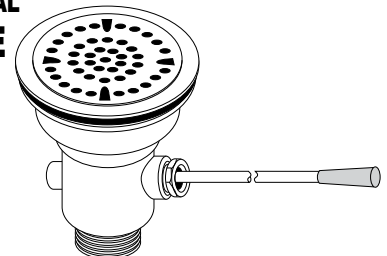

- Heavy nickel plated bronze body
- Stainless steel strainer and flange
- Counter sunk flange will fit virtually all sinks

55-731 Genuine Advantage Lever Waste **69.61**

ADVANTAGE™

(FRANKLIN# 100-1031)
(T&S# B-3912)



3-1/2" SINK OPENING
X

**1-1/2" DRAIN OUTLET
HEAVY DUTY COMMERCIAL
TWIST HANDLE
WASTE**

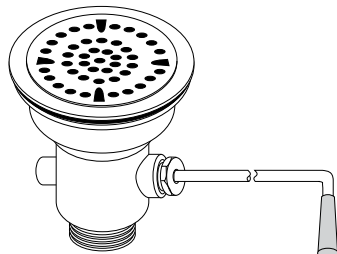

- Heavy nickel plated bronze body
- Stainless steel flange and strainer
- Twist handle
- Counter sunk flange will fit virtually all sinks

55-734 Genuine Advantage Waste **69.61**

ADVANTAGE™

(FRANKLIN# 100-1039)
(T&S# B-3913)



3-1/2" SINK OPENING
X

**2" DRAIN OPENING
HEAVY DUTY COMMERCIAL
TWIST HANDLE
WASTE**

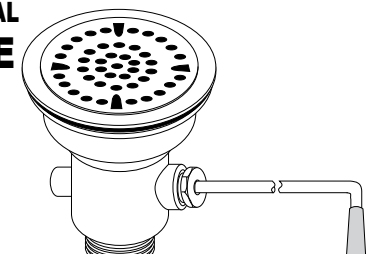

- Heavy nickel plated bronze body
- Stainless steel flange and strainer
- Twist handle
- Counter sunk flange will fit virtually all sinks

55-735 Genuine Advantage Waste **69.61**

**USE YOUR CREDIT CARD AT TIME OF PURCHASE AND SAVE 2% ON ALL ORDERS,
SAVE 5% ON ALL ORDERS OVER \$500 OR SAVE 10% ON ALL ORDERS OVER \$1000**

FAX 1-800-982-5934 www.HODESCO.com PHONE 1-800-777-6500
PROFFERED PLUMBING PRODUCTS 215

COMMERCIAL DRAINS



ADVANTAGE™

(Franklin 100-1011)

**WASTE
REPAIR
KIT**

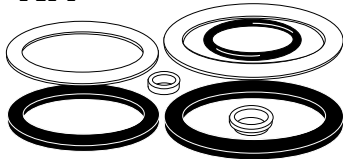

- Repairs both 3" and 3-1/2" lever and trip wastes
- Contains: one each 3" and 3-1/2" flange washer and gasket, body bushing, packing nut bushing and plunger O-Ring
- Interchangeable with Advantage machine products

55-736 Genuine Advantage Waste Repair Kit . . . **14.18**

ADVANTAGE™

(Franklin 100-1027)

**TWIST HANDLE
ASSEMBLY**

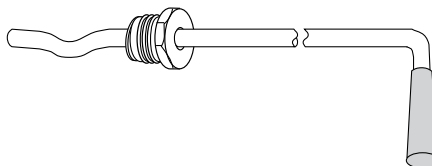

55-742 Genuine Advantage Twist Handle . . . **17.39**

ADVANTAGE™

(Franklin 100-1004)

**PLUNGER
WITH O-RING**

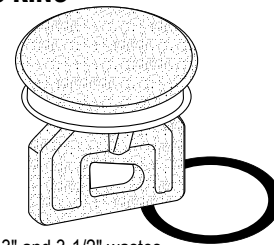

- Repairs both 3" and 3-1/2" wastes
- Repairs both lever and twist handle wastes
- Includes O'Ring

55-741 Genuine Advantage Plunger **14.15**

55-743 Washer Only **1.85**

ADVANTAGE™

(Franklin 100-1005)

**3-1/8" DIAMETER
STAINLESS STEEL
FLAT STRAINER
PLATE**

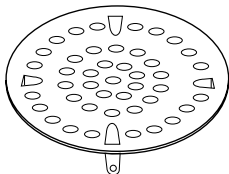

- Repairs both lever and twist handle wastes

55-739 Genuine Advantage Strainer **8.20**

ADVANTAGE™

(Franklin 100-1013)

**3-7/16" DIAMETER
STAINLESS STEEL
FLAT STRAINER
PLATE**

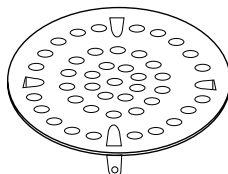

- Repairs both lever and twist handle wastes

55-740 Genuine Advantage Strainer **8.20**

ADVANTAGE™

(Franklin 100-1042)

**DRAIN OUTLET
REDUCER
BUSHING**

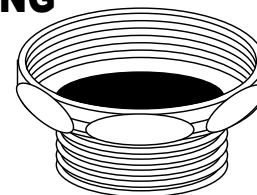

- Reduces 2" drain outlet to 1-1/2" tubing size
- Heavy nickel plated bronze bushing with gasket
- 2" female NPT x 1-1/2" male NPT

55-746 Genuine Advantage Reducer Bushing **14.01**

ADVANTAGE™

(Franklin 100-1010)

**3" STAINLESS STEEL
FACE FLANGE
ASSEMBLY**

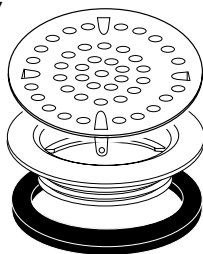

- Repairs both lever and twist handle wastes

55-737 Genuine Advantage Flange **19.97**

ADVANTAGE™

(Franklin 100-1016)

**3-1/2" STAINLESS STEEL
FACE FLANGE
ASSEMBLY**

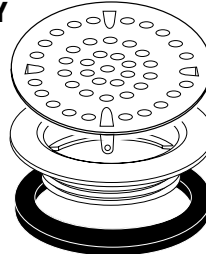

- Repairs both lever and twist handle wastes

55-738 Genuine Advantage Flange **19.97**



**PAY BY MAJOR CREDIT CARD
WHEN YOU PLACE YOUR ORDER
AND SAVE UP TO AN
ADDITIONAL 10%
OFF OUR ALREADY
INDUSTRY-LOW PRICES!!**

**USE YOUR CREDIT CARD AT TIME OF PURCHASE AND SAVE 2% ON ALL ORDERS,
SAVE 5% ON ALL ORDERS OVER \$500 OR SAVE 10% ON ALL ORDERS OVER \$1000**

1-800-982-5934
216

www. **HODES CO.** .com
PREFERRED PLUMBING PRODUCTS

1-800-777-6500

COMMERCIAL DRAIN

AMERICAN PLUMBER



FAUCETS AND EXTERNAL TRIM

American PLUMBER™ SLIMLINE UNDER-SINK WATER FILTER

(W38-PR)

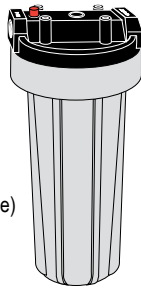

- 3/8" inlet/outlet
- Provides cleaner/better tasting drinking water
- Reduces bad taste/odor, chlorine, sediment, cysts, lead and mercury
- Cartridge not included(see next page)
- Includes pressure relief button
- 1 per package
- 6 per case
- Use 55-079, 55-081, 55-080, 55-070, 55-071, 55-093, 55-098, 55-067 or 55-063 Filters

55-063 Genuine Water Filter **27.15**

American PLUMBER™ WHOLE HOUSE WATER FILTER

(W34-PR)

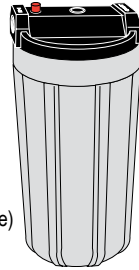

- 3/4" inlet/outlet
- Extends life of household appliances
- Reduces sand, dirt, silt, rust particles and scale particles
- With pressure relief button
- Cartridge not included(see next page)
- 1 per package
- 6 per case
- Use 55-079, 55-081, 55-080, 55-070, 55-071, 55-093, 55-098, 55-067 or 55-063 Filters

55-061 Genuine Water Filter (Grey) **32.58**

55-064 Genuine Water Filter (Clear) **NEW** **43.16**

American PLUMBER™ DELUXE WHOLE HOUSE WATER FILTER

(WVC34)

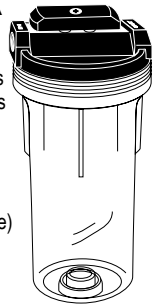

- Includes built-in shut-off valve
- 3/4" inlet/outlet
- Extends life of household appliances
- Reduces sand, dirt, silt, rust particles and scale particles
- Valve-in-Head feature for easy cartridge changes
- With pressure relief button
- Cartridge not included(see next page)
- 5 year limited warranty
- 1 per box
- 6 per case
- Use 55-079, 55-081, 55-080, 55-070, 55-071, 55-093, 55-098, 55-067 or 55-063 Filters

55-060 Genuine Water Filter **59.13**

American PLUMBER™ HEAVY-DUTY WHOLE HOUSE WATER FILTER

(W10-PR)

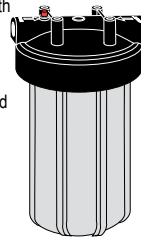

- High flow for house filtration
- 1" inlet/outlet
- Includes pressure relief button - 10" length
- Provides up to 4 times the capacity of standard 3/4" filter housings
- Extends life of household appliances
- Reduces sand, dirt, silt, rust particles, and scale particles
- Cartridge not included(see next page)
- Offers high-flow/heavy sediment capabilities
- 1 per box
- 2 per case
- Use 55-066, 55-065 or 55-094 filter

55-062 Genuine Water Filter **85.46**

American PLUMBER™ UNDER SINK REVERSE OSMOSIS WATER SYSTEM

(WRO-3000)



- 26 Gallons
 - Includes faucet and tubing
- The following standard filters are included:
55-093 & 55-068

55-074 Reverse Osmosis System **440.57**

American PLUMBER™ 3/8" I.D. COMPACT HOUSING

(W385-PR)

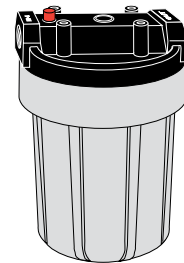

- Includes mounting brackets
 - Use 55-077 filter
- 55-076 Compact Housing **27.15**

American PLUMBER™ MONITORED WHOLE HOUSE CARTRIDGE

(W34-PRM)



- Three color monitor indicates when to change cartridge
- Integral mounting bracket
- 3/4" NPT inlet/outlet
- Equipped with pressure relief valve
- Accepts a wide variety of 2-1/2" to 3" diameter cartridges
- Includes WPD-110, 5 micron sediment cartridge
- Includes WW34 housing wrench #55-086

55-051 Monitored Whole House Cartridge **133.76**

American PLUMBER™ SILICONE O-RING FOR HOT-HIGH PRESSURE HOUSINGS

(W34-ORS)

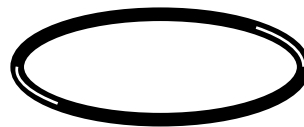

- For 55-060
- 55-040 O-Ring **15.03**

American PLUMBER™ BUNA-N O-RING

(W34-OR)
(W10-OR)
(W38-OR)

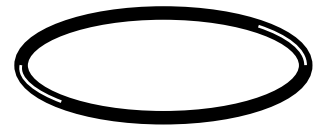

- 55-041 3/4" Standard Housing(55-061) **3.96**
- 55-042 1" & 1-1/2" Standard Housing(55-062) **6.97**
- 55-043 3/8" Slimline & Compact Housing **3.88**

USE YOUR CREDIT CARD AT TIME OF PURCHASE AND SAVE 2% ON ALL ORDERS, SAVE 5% ON ALL ORDERS OVER \$500 OR SAVE 10% ON ALL ORDERS OVER \$1000

FAX 1-800-982-5934 www.HODES CO.com PHONE 1-800-777-6500
PROFFERED PLUMBING PRODUCTS 217

AMERICAN PLUMBER



American PLUMBER™ (152039)

SPANNER WRENCH



Fits all 10" housing and 1" whole house systems

55-087 Spanner Wrench... **13.35**

American PLUMBER™ (152037)

SPANNER WRENCH



Fits item #s 55-060 and 55-061

55-086 Spanner Wrench... **8.28**

American PLUMBER™ (152-040)

MOUNTING BRACKET

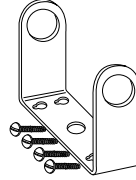

For 3/4" housings

55-088 Mounting Bracket... **10.21**

American PLUMBER™ (150062)

MOUNTING BRACKET

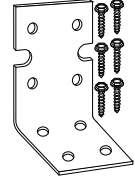

For item #55-062

55-089 Mounting Bracket... **38.82**

American PLUMBER™ (WCC) **NSF** Certified for Use in Food Service

FILTER CARTRIDGE GRANULAR ACTIVATED CARBON

- Reduces chlorine, bad tastes, odor, sand, dirt, silt, rust & scale particles
- Up-flow design maximizes water/carbon contact time for more effective chlorine reduction
- 20 micro nominal filtration
- 6 month filter life
- 500 gallon capacity
- Fits most other standard size water filter housing
- 1 per package
- 4 per case

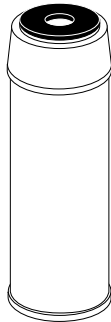

55-068 Genuine Filter Cartridge... **17.82**

American PLUMBER™ (WICSA) **NSF** Certified for Use in Food Service

QUICK CONNECT ICEMAKER FILTER

- Includes quick-connect fittings for easy installation behind refrigeration
- 40-100° F temperature range
- Reduces bad tastes / odors
- 1/4" in-line
- Disposable 6 month replacement date after installations
- 1 per package
- 6 per case



55-069 Genuine Filter Cartridge... **22.13**

American PLUMBER™ (WIC) **NSF** Certified for Use in Food Service

TASTE, ODOR, SCALE ICE MAKER FILTER

1/4" in line filter
12" length



55-084 Ice Maker Filter... **26.87**

American PLUMBER™ (WGC478)

TASTE, ODOR CARBON FILTER

- 20 micron filter



NEW

55-044 Genuine Carbon Filter... **12.80**

American PLUMBER™ (WDGD 5005)

REPLACEMENT CARTRIDGE

- 50 micron x 5 micron
- Dual gradient density sediment cartridge for heavy duty filtration

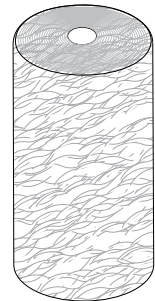

55-094 Genuine Cartridge... **20.34**

American PLUMBER™ (WRC25HD) **NSF** Certified for Use in Food Service

HEAVY-DUTY FILTER CARTRIDGE RADIAL-FLOW CARBON

- Radial - flow design allows higher flow rates
- Reduces chlorine, bad tastes / odors, coarse sand, rust/scale particles
- 25 micron nominal filtration
- 2 month filter life
- 5000 gallon capacity
- Fits most other heavy - duty water filter housings
- 1 per package
- 4 per case

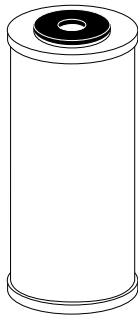

55-066 Genuine Filter Cartridge... **55.33**

American PLUMBER™ (WGCHD)

HEAVY-DUTY FILTER CARTRIDGE

- Up flow design maximizes water/carbon contact time for effective chlorine, taste and odor reduction
- Taste/Odor/Chlorine
- Granular activated carbon
- Flow rate up to 6 GPM
- 20 micron
- Fits #55-062
- 3 month filter life (12,000 gallon capacity)



55-050 Genuine Heavy-Duty Filter Cartridge... **40.67**

American PLUMBER™ (W5CPHD)

HEAVY-DUTY SEDIMENT CARTRIDGE

- Reduces extra fine sand, dirt, silt, Rust and Scale Particles
- 5 micron
- 4 month filter life



NEW

55-045 Genuine Heavy-Duty Cartridge... **23.03**

USE YOUR CREDIT CARD AT TIME OF PURCHASE AND SAVE 2% ON ALL ORDERS, SAVE 5% ON ALL ORDERS OVER \$500 OR SAVE 10% ON ALL ORDERS OVER \$1000

AMERICAN PLUMBER



FAUCETS AND EXTERNAL TRIM

American PLUMBER™ WHOLE HOUSE FILTER CARTRIDGE PLEATED CELLULOSE

(W2OCL)



- Reduces sand, dirt, silt, rust & scale particles
- High dirt-holding capacity for extended cartridge life
- Recommended for chlorinated water supplies
- 20 micro nominal filtration
- 4 month filter life
- 16,000 gallon capacity
- Fits most other standard size water filter housings
- Priced each 12 per case

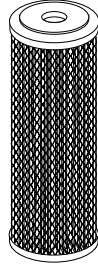

SOLD 2 PER PACKAGE ONLY

55-067 Genuine Filter Cartridge **5.55**

American PLUMBER™ SEDIMENT CARTRIDGE

(W5W)

- Polypropylene wound cord
- Standard length - 10"
- 5 micron



SOLD 2 PER PACKAGE ONLY

55-079 Sediment Cartridge..... **5.37**

American PLUMBER™ SEDIMENT CARTRIDGE

(W5P)

- Spun polypropylene fibers
- 5 micron
- Standard length - 10"

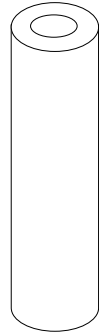

SOLD 2 PER PACKAGE ONLY

55-081 Sediment Cartridge..... **7.51**

American PLUMBER™ SEDIMENT CARTRIDGE

(W30W)

- Polypropylene wound cord
- Standard length - 10"
- 30 micron

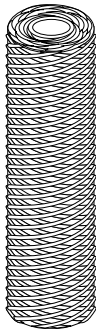

SOLD 2 PER PACKAGE ONLY

55-080 Sediment Cartridge..... **7.36**

American PLUMBER™ POLY-BOND POLYPROPYLENE SEDIMENT DELUXE FILTER CARTRIDGE

(W5PB)

- Micro-fiber construction offers no fiber release 5 micron
- Consistent flow rate and superior filtration performance
- Provides superior chemical resistance & not prone to bacterial attack
- Constructed of quality polypropylene filter media for higher filtration efficiency
- Priced each 12 per case

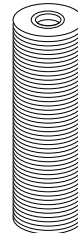

SOLD 2 PER PACKAGE ONLY

55-070 Genuine Filter Cartridge..... **6.73**

American PLUMBER™ SEDIMENT FILTER CARTRIDGE PLEATED POLYESTER

(W50PE)
(W50PEHD)



- Reduces coarse sand rust / scale particles
- Protects plumbing fixtures and valuable applications
- High dirt-holding capacity for extended filter life
- Ideal for well-water applications
- 50 micron nominal standard size water filter housings
- 12 per case

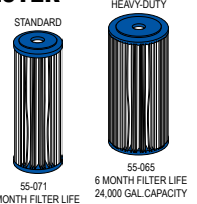

SOLD 2 PER PACKAGE ONLY

55-071 Genuine Standard Priced Each ... **10.01**
Sold 1 Per Package (8 Per Case)

55-065 Genuine Heavy - Duty **21.73**

American PLUMBER™ COMPACT CARTRIDGE

(W5C1P478)

- Taste & odor
- Activated carbon impregnated cellulose
- 4-7/8" length
- 5 micron

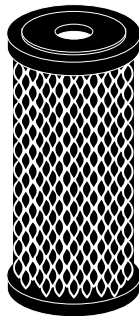

SOLD 2 PER PACKAGE ONLY

55-077 Compact Cartridge..... **9.46**

American PLUMBER™ REPLACEMENT CARTRIDGE

(W5CIP)

- Activated carbon impregnated cellulose
- 5 Micron
- Low end carbon cartridge
- Sediment/Taste/Odor
- Fits any standard 3/8 or 3/4" housing

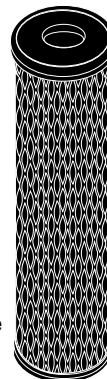

SOLD 2 PER PACKAGE ONLY

55-093 Cartridge..... **10.82**

American PLUMBER™ REPLACEMENT CARTRIDGE

(WLC-R)

- Fits 55-083
- 5 Micron block cartridge
- Taste/Odor/Chemical/Lead/Mercury/Cyst
- Replacement for W-40 cartridge

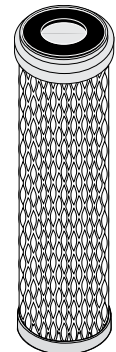

55-098 Cartridge..... **33.94**

USE YOUR CREDIT CARD AT TIME OF PURCHASE AND SAVE 2% ON ALL ORDERS, SAVE 5% ON ALL ORDERS OVER \$500 OR SAVE 10% ON ALL ORDERS OVER \$1000

FAX 1-800-982-5934 www.HODESCO.com PHONE 1-800-777-6500
PROFFERED PLUMBING PRODUCTS 219

AMERICAN PLUMBER



Waste King Legend Series
by Anaheim Manufacturing Company

(9920)

1/2 HORSEPOWER WITH POWER CORD 2 YEAR WARRANTY



- Septic safe
- Best warranty in the industry
- Professional 3-bolt mount
- Vortex powered, permanent magnet motors
- 2600 R.P.M. Stainless steel impellers
- NOT SOLD IN RETAIL BOX STORES

AVAILABLE ONLY TO PLUMBING CONTRACTORS

54-121 Waste King 1/2 Horsepower Disposer 109.26

Waste King Legend Series
by Anaheim Manufacturing Company

(9930)

1/2 HORSEPOWER WITH POWER CORD 5 YEAR WARRANTY



- Septic safe
- Best warranty in the industry
- Professional 3-bolt mount
- Vortex powered, permanent magnet motors
- Lifetime corrosion warranty
- 2600 R.P.M.
- Stainless steel impellers
- NOT SOLD IN RETAIL BOX STORES

AVAILABLE ONLY TO PLUMBING CONTRACTORS

54-122 Waste King 1/2 Horsepower Disposer 133.88

Waste King Legend Series
by Anaheim Manufacturing Company

(9940)

3/4 HORSEPOWER WITH POWER CORD 8 YEAR WARRANTY



- Septic safe
- Best warranty in the industry
- Professional 3-bolt mount
- Vortex powered, permanent magnet motors
- Lifetime corrosion warranty
- 2600 R.P.M. Stainless steel impellers
- NOT SOLD IN RETAIL BOX STORES

AVAILABLE ONLY TO PLUMBING CONTRACTORS

54-123 Waste King 3/4 Horsepower Disposer 183.15

Waste King Legend Series
by Anaheim Manufacturing Company

(9950)

3/4 HORSEPOWER WITH POWER CORD 10 YEAR WARRANTY



- Septic safe
- Best warranty in the industry
- Professional 3-bolt mount
- Lifetime corrosion warranty
- 2700 R.P.M. Stainless steel impellers
- NOT SOLD IN RETAIL BOX STORES

AVAILABLE ONLY TO PLUMBING CONTRACTORS

54-124 Waste King 3/4 Horsepower Disposer 221.68

Waste King Legend Series
by Anaheim Manufacturing Company

(9980) (9980TC)

1 HORSEPOWER DISPOSERS



- Septic safe
- Best warranty in the industry
- Professional 3-bolt mount
- Lifetime corrosion warranty
- NOT SOLD IN RETAIL BOX STORES

AVAILABLE ONLY TO PLUMBING CONTRACTORS

54-125 Waste King 1 Horsepower Disposer 325.43
54-126 Waste King 1 Horsepower Batch Feed Disposer 334.75

NEW

Waste King Legend Series
by Anaheim Manufacturing Company

(9900TC)

3/4 HORSEPOWER BATCH FEED DISPOSER 10 YEAR WARRANTY

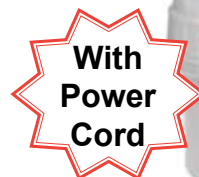

- Septic safe
- Best warranty in the industry
- Professional 3-bolt mount
- NOT SOLD IN RETAIL BOX STORES

AVAILABLE ONLY TO PLUMBING CONTRACTORS

54-130 Waste King 3/4 Horsepower Batch Feed Disposer 295.85

NEW

USE YOUR CREDIT CARD AT TIME OF PURCHASE AND SAVE 2% ON ALL ORDERS, SAVE 5% ON ALL ORDERS OVER \$500 OR SAVE 10% ON ALL ORDERS OVER \$1000



DISPOSERS

See www.HodesCo.com
for Case Lot Pricing



FAUCETS AND EXTERNAL TRIM

in sink erator EvolutionPRO Series

(COMPACT)

3/4 HORSEPOWER STAINLESS STEEL FOOD WASTE DISPOSER

- Soundseal Technology™ - 40% quieter than standard disposer
- Multigrind™ Technology - 2 grind stages vs. 1 in standard disposer
- 34.6 ounce stainless steel grind chamber and components
- For small households or restricted cabinet space
- 3/4 horsepower
- 4 year warranty



COMPACT

54-202 Evolution Compact™ 3/4 Horsepower Disposer **283.62**
54-211 With Service Cord **276.04**

in sink erator EMERSON®

(101)
(101W/C)

1/3 HORSEPOWER FOOD WASTE DISPOSER

- Same as #54-101 (Badger 1) & 54-109 (Badger 1 w/ cord)
- Different color - gray instead of black
- Same warranty - 1 year
- Not sold in retail box stores
- Less expensive
- No ISE print on flange, otherwise, same product

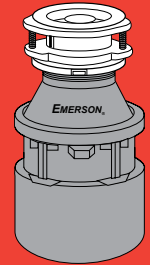

54-901 1/3 Horsepower Disposer **77.66**
54-909 1/3 Horsepower Disposer with Cord **83.28**

in sink erator EvolutionPRO Series

(ESSENTIAL)

3/4 HORSEPOWER HEAVY DUTY STAINLESS STEEL FOOD WASTE DISPOSER

- Soundseal Technology™ - 40% quieter than standard disposer
- Multigrind™ Technology - 2 grind stages vs. 1 in standard disposer
- 40 ounce stainless steel grind chambers and components
- 3/4 horsepower
- 6 year warranty



ESSENTIAL

54-204 Evolution Essential™ 3/4 Horsepower Disposer **326.42**

in sink erator EMERSON®

(202)
(202W/C)

1/2 HORSEPOWER FOOD WASTE DISPOSER

- Shorter than the #54-105 (Badger 5) & 54-110 (Badger 5 w/ cord)
- Different color - gray instead of black
- 1 year warranty
- Not sold in retail box stores
- Less expensive
- No ISE print on flange

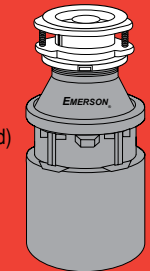

54-905 1/2 Horsepower Disposer **89.00**
54-910 1/2 Horsepower Disposer with Cord **94.56**

in sink erator EvolutionPRO Series

(EXCEL)

ONE HORSEPOWER STAINLESS STEEL FOOD WASTE DISPOSER

- Soundseal Technology™ - 60% quieter than standard disposer
- Multigrind™ Technology - 3 grind stages vs. 1 in standard disposer
- 40 ounce stainless steel grind chamber and components
- Jam-Sensor Circuit™ feature
- Auto-Reverse Grind System™ feature
- 1 horsepower
- 7 year warranty



EXCEL

54-206 Evolution Excel One Horsepower Disposer **526.75**

in sink erator®

(BADGER 1)

1/3 HORSEPOWER FOOD WASTE DISPOSER

- Tough galvanized steel shredder ring
- Stainless steel sink flange
- Exclusive self-service "wrench" frees simple jams
- 1 year warranty
- 1 per box

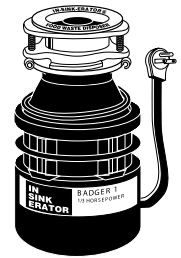

BADGER 1

54-101 ISE 1/3 HP Disposer **97.53**
54-109 ISE 1/3 HP Disposer with Service Cord **100.42**

in sink erator EvolutionPRO Series

(COVER CONTROL)

3/4 HORSEPOWER HEAVY DUTY STAINLESS STEEL FOOD WASTE DISPOSER

- Soundseal Technology™ - 60% quieter than standard disposer
- Multigrind™ Technology - 2 grind stages vs. 1 in standard disposer
- 40 ounce stainless steel grind chamber and components
- Magnetic CoverStart™ activation
- 3/4 horsepower
- 7 year warranty



COVER CONTROL

54-208 Evolution Cover Control 3/4 Horsepower Disposer **348.68**

in sink erator®

(BADGER 5)

1/2 HORSEPOWER FOOD WASTE DISPOSER

- Tough galvanized steel shredder ring
- Stainless steel sink flange
- Exclusive self-service "wrench" frees simple jams
- 2 year warranty
- 1 per box



BADGER 5

54-105 ISE 1/2 HP Disposer **110.18**
54-110 ISE 1/2 HP Disposer with Service Cord **119.13**

**USE YOUR CREDIT CARD AT TIME OF PURCHASE AND SAVE 2% ON ALL ORDERS,
SAVE 5% ON ALL ORDERS OVER \$500 OR SAVE 10% ON ALL ORDERS OVER \$1000**

FAX 1-800-982-5934 www.HODES CO.com PHONE 1-800-777-6500
PROFFERED PLUMBING PRODUCTS 221

DISPOSERS

FAUCETS AND EXTERNAL TRIM



DISPOSER ACCESSORIES



MOUNTING GASKETS

(SMG-00)
(DMG-00)

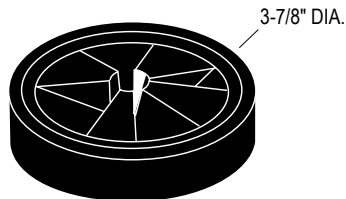

53-334 For Badger Models Only(6) . . . **12.25**
53-335 For Deluxe Models Only(6) . . . **14.21**

CASE

QTY

**QUICK & HOT
HOT WATER
DISPENSER**

H520-U-CH

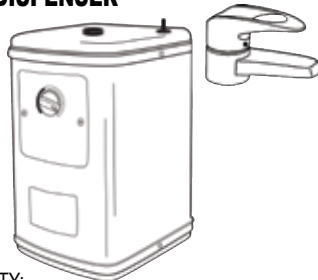

- CAPACITY:
5/8 Gallon (2.3L). Up to 60 cups per hour
- TEMPERATURE RANGE:
Adjustable from 140°F to 190°F (60°C to 88°C)

NEW

54-115 Hot Water Dispenser **364.54**



**CHROME FINISH
HOT WATER
DISPENSER**

(H-990C)

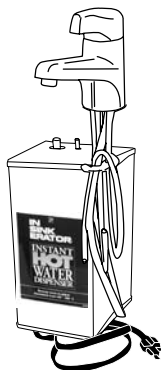

- System provides up to 60 cups of 190° water per hour
- Faucet completely insulated from 190° water
- Die-molded, high efficiency, expanded polystyrene thermal barrier surrounds tank for low heat loss
- Adjustable thermostat, convenient drain, thermally fused to prevent tank damage from dry start-up or loss of water
- Tank is always open to atmospheric pressure and requires no relief valves
- 1/2 gallon capacity insulated tank with drain screw, chrome finish faucet, instant self-closing valve and adjustable thermostat

54-114 Hot Water Dispenser **370.03**

**ISE / BADGER
RUBBER
"HUSH" CUSHION**



SOLD 2 PER PACKAGE ONLY

53-315 Generic Cushion **1.76**

**OUTLET
GASKET**

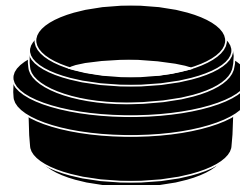

53-324 Genuine Gasket **2.90**

**3 PIECE UNIVERSAL GARBAGE
DISPOSAL KIT**

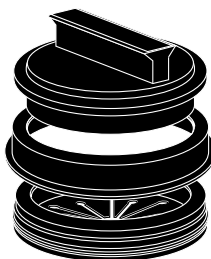

• For Insinkerator and Whirl-A-Way
53-339 Disposal Kit **4.01**



(70966)

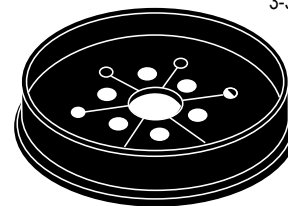

53-332 Genuine Splashguard(6) . . . **10.73**

CASE

QTY

**ISE
IN-SINK-ERATOR
STAINLESS STEEL
STOPPER**

(STPSS)

3-1/4" DIA.

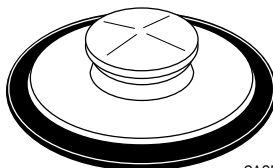

53-331 Genuine S.S. Stopper(6) . . . **19.69**

CASE

QTY

**DISPOSER
ELBOW**

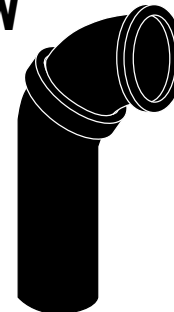

53-323 Disposer Elbow **2.65**

**ISE
IN-SINK-ERATOR
STAINLESS STEEL
SINK
FLANGE**



NEW

54-116 Genuine S.S. Sink Flange **19.79**

**POWER CORD
ASSEMBLY**

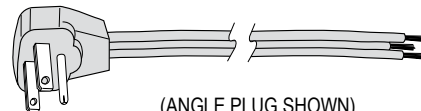

(ANGLE PLUG SHOWN)

- Meets OSHA requirements for indoor use and general purpose applications
 - UL listed
 - 13A – 125V
- 91-318 Generic 4' Straight Plug Cord .(6) . . . **5.53**
91-319 Generic 6' Straight Plug Cord .(6) . . . **7.54**
91-316 Generic 6' Angle Plug Cord . . .(6) . . . **7.40**

CASE

QTY:

**USE YOUR CREDIT CARD AT TIME OF PURCHASE AND SAVE 2% ON ALL ORDERS,
SAVE 5% ON ALL ORDERS OVER \$500 OR SAVE 10% ON ALL ORDERS OVER \$1000**

FAX 1-800-982-5934 www.HODES CO.com PHONE 1-800-777-6500
222

DISPOSER ACCESSORIES

SINK STRAINERS



**FAUCETS AND
EXTERNAL TRIM**

STAINLESS STEEL BASKET STRAINER

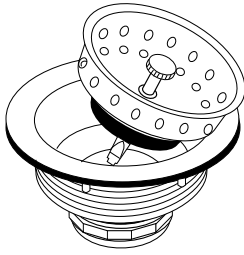

- Solid post
- Steel nut
- Neoprene seat
- 3-1/2" locknut
- 1 per heavy corrugated box

47-050 Complete Basket Strainer..... **4.09**

STAINLESS STEEL BASKET STRAINER

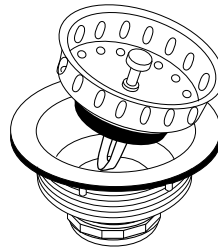

- Steel nut
- Neoprene seat
- 3-1/2" locknut
- 1 per box

52-050 Complete Basket Strainer..... **9.41**

QUICK FIT STAINLESS STEEL BASKET STRAINER

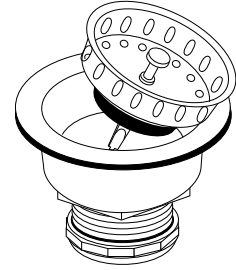

- Neoprene basket
- Cup style strainer
- Deep drawn stainless steel with rolled threads
- Fits 3-1/2" to 4" drain openings
- Metal clip style basket
- 1-1/2" locknut
- 1 per box

52-106 Complete Basket Strainer..... **8.25**

DOMESTIC
COMPARE
IMPORTED

"BALL CHEK" SINK STRAINER

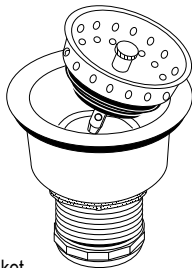

- Stainless steel basket
- Stainless steel body
- Neoprene seat
- Leak-proof "ball chek" positive seal
- Locking shell
- 1 per heavy corrugated box

47-080 Complete Sink Strainer..... **10.34**

"PUSH-N-SEAL" SINK STRAINER

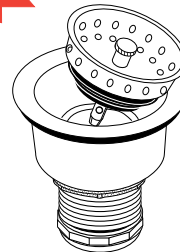

- Stainless steel basket
- Stainless steel body
- Neoprene seat
- Leak-proof "ball-lok" positive seal
- Locking shell
- 1 per box

52-180 Complete Sink Strainer..... **18.55**

DOMESTIC
COMPARE
IMPORTED

GENUINE LUCKY 7 STAINLESS STEEL BASKET STRAINER

(L7)

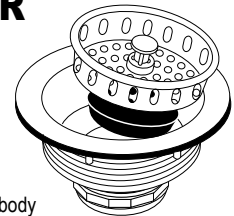

- Chrome plated brass body
- Stainless steel basket
- Metal post
- Heavy locknut
- Extra thick washer
- Machine cut threads

52-007 Lucky 7 Basket Strainer..... **16.63**

DELUXE DEEP DISH STAINLESS STEEL SINK STRAINER

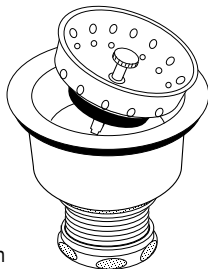

- Deep pattern
- Locking shell
- Neoprene seal
- Brass lock & coupling nuts
- 1 per heavy corrugated box

47-105 Complete Deluxe Strainer..... **11.22**

DELUXE DEEP DISH STAINLESS STEEL SINK STRAINER

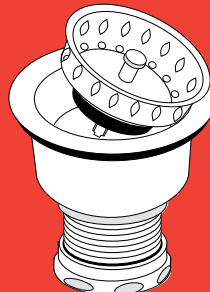

- Deep pattern
- Locking shell
- Neoprene seal
- Brass lock & coupling nuts
- 1 per heavy corrugated box

52-105 Complete Deluxe Strainer..... **20.03**

DOMESTIC
COMPARE
IMPORTED

FORGED BRASS BASKET STRAINER

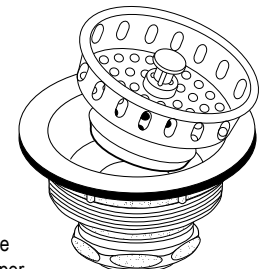

- Polished chrome
- Brass G.J. stopper
- Heavy cut threads
- 3-1/2" brass locknut
- 1-1/2" brass coupling nut
- 1 per heavy corrugated box

52-118 Complete Basket Strainer..... **20.06**

**USE YOUR CREDIT CARD AT TIME OF PURCHASE AND SAVE 2% ON ALL ORDERS,
SAVE 5% ON ALL ORDERS OVER \$500 OR SAVE 10% ON ALL ORDERS OVER \$1000**

**FAX
1-800-982-5934**

www.HODES CO.com
PROFFERED PLUMBING PRODUCTS

**PHONE
1-800-777-6500
223**



**SURELOCK
BASKET STRAINER**

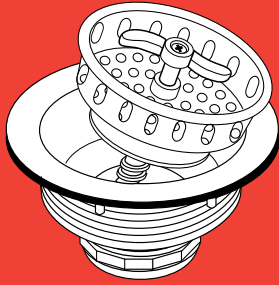

- 3-1/2" diecast locknut
- 1-1/2" coupling nut
- All stainless steel
- 1 per heavy corrugated box

47-070 Complete Basket Strainer **8.13**

**SPIN 'N GRIN
BASKET STRAINER**

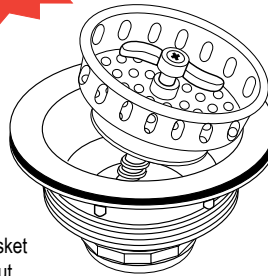

- CP brass body
- Stainless steel basket
- 3-1/2" brass locknut
- 1-1/2" brass coupling nut
- 1 per heavy corrugated box

52-200 Complete CP Basket Strainer **30.57**

**WROUGHT BRASS
STRAINER**

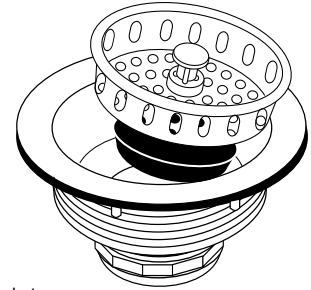

- Universal basket
- Polished chrome
- 3-1/2" D.C. locknut
- 1-1/2" D.C. coupling nut
- 1 per heavy corrugated box

52-109 Complete Wrought Brass Strainer ... **16.68**

**DUPLEX
STRAINER**

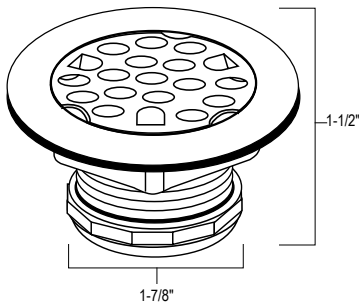

- Stainless steel
- 1-1/2" IPS body — 2-7/8" flange
- 1 per box

52-103 CP Flat Strainer **4.59**

**DEEP DUO
STRAINER**

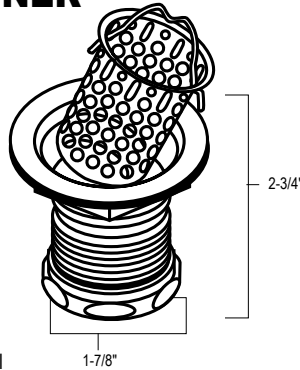

- Stainless steel
- Deep basket
- 1-1/2" IPS body — 2-7/8" flange
- 1 per box

52-102 Complete Duplex Strainer **13.78**



**PAY BY MAJOR CREDIT CARD
WHEN YOU PLACE YOUR ORDER
AND SAVE UP TO AN
ADDITIONAL 10%
OFF OUR ALREADY
INDUSTRY-LOW PRICES!!**

SINK STRAINERS

**EEZ-ON
BASKET STRAINER**

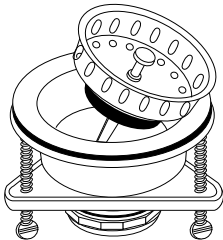

- Fits all sinks
- All stainless steel
- Cuts installation time in half
- Special metal triangular retainer and thumb screws
- Triangular base
- 1 per box

52-137 EEZ-ON Basket Strainer **10.40**

**JR. DUO
STRAINER**

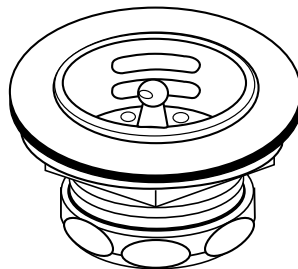

- Stainless steel
- 2-3/4" flange
- 1 per box

52-128 Complete Jr. Duo Strainer **3.24**

**INDUSTRIAL
SINK PLUG**

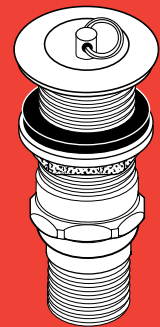

- Cast brass with cast brass stopper
- 1" size with tailpiece
- 1 per heavy corrugated box

52-110 Industrial Sink Plug **12.21**

**USE YOUR CREDIT CARD AT TIME OF PURCHASE AND SAVE 2% ON ALL ORDERS,
SAVE 5% ON ALL ORDERS OVER \$500 OR SAVE 10% ON ALL ORDERS OVER \$1000**

SINK STRAINER CUPS



**FAUCETS AND
EXTERNAL TRIM**

UNIVERSAL BASKET

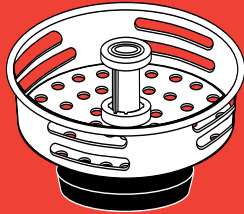

- Stainless steel
- Neoprene stopper
- For many different strainers

52-108 Basket Only **1.77**

SURELOCK BASKET

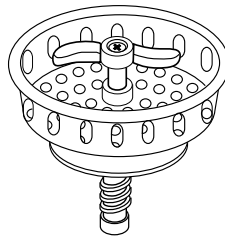

- Basket only for 47-070 strainer

47-171 Basket Only **4.42**

BASKET



- For 52-118 strainers

NEW

52-123 Basket Only **9.35**

LUCKY 7 BASKET



- Stainless steel
- For 52-007 strainers

NEW

52-124 Lucky 7 Basket Only **5.72**

BASKET

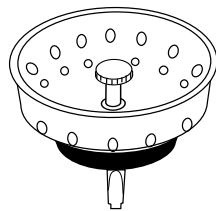

- Stainless steel
- For 47-050, 47-105, 52-050 & 52-105 strainers

47-107 Basket Only **1.57**

BASKET

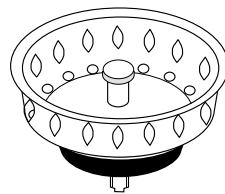

- Stainless steel
- For 47-050, 47-105, 52-050 & 52-105 strainers

52-107 Deluxe Basket Only **5.24**

EEZ-ON BASKET

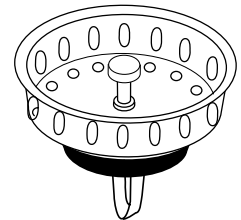

- Basket only for 52-137

52-138 Basket Only **4.61**

"BALL-CHEK" BASKET

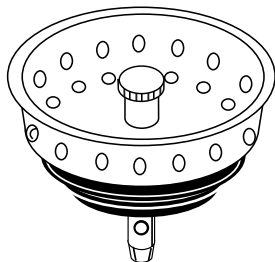

- Basket only for 47-080 strainer

47-081 Basket Only **2.91**

STAINLESS STEEL STRAINERS

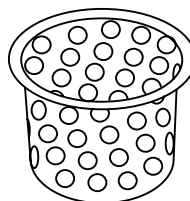

SOLD 2 PER PACKAGE ONLY

52-125 1-1/4" **1.71**

52-126 1-1/2" **1.71**

CHROME PLATED BRASS DEEP BASKET

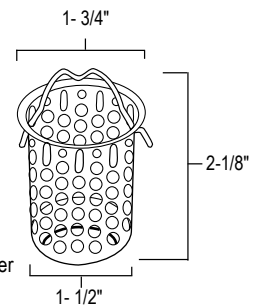

- For use with duo strainer
- Chrome plated brass
- For 52-102 strainer

52-127 Deep Basket Only **4.28**

**USE YOUR CREDIT CARD AT TIME OF PURCHASE AND SAVE 2% ON ALL ORDERS,
SAVE 5% ON ALL ORDERS OVER \$500 OR SAVE 10% ON ALL ORDERS OVER \$1000**

**FAX
1-800-982-5934**

www.HODES CO.com
PROFFERED PLUMBING PRODUCTS

**PHONE
1-800-777-6500
225**

SINK STRAINER CUPS

FAUCETS AND EXTERNAL TRIM



SINK REPAIR

1-3/4" STANDARD FAUCET HOLE COVER

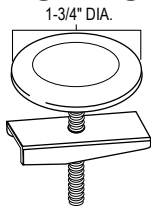

SOLD 12 PER BOX ONLY
24-097 Hole Cover **1.33**

3" FAUCET HOLE COVER

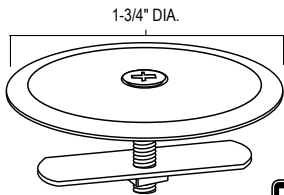

NEW
24-096 3" Hole Cover **4.69**

HODES CO
PROFERRED PLUMBING PRODUCTS
Case Lot Pricing
available at
www.HodesCo.com

PLASTIC LOCKNUT

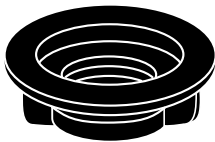

• Heavy gauge ABS plastic
SOLD 10 PER PACKAGE ONLY
24-098 Plastic Locknut **.57¢**

RUBBER STOPPER WITH CHROMED BRASS STAY RING



SOLD 5 PER PACKAGE ONLY
25-107 1-1/4" **1.00**
25-108 1-3/8" **1.04**
25-109 1-1/2" **1.10**
25-111 1-3/4" **1.14**

DELUXE FAUCET HOLE COVER

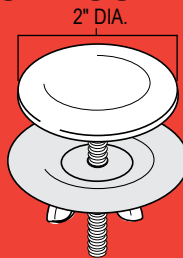

• Large faucet hole cover furnished with putty cup and wing nut

SOLD 12 PER BOX ONLY
24-100 Hole Cover **1.66**

WHITE FAUCET HOLE COVER WITH WING NUT

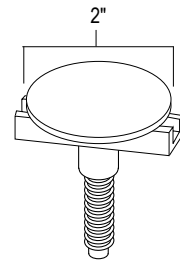

• 1 per bar coded display package

24-105 White Faucet Hole Cover **2.35**

BRASS COUPLING NUT

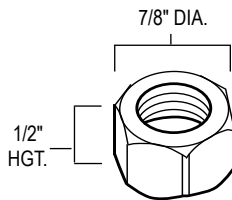

• Heavy duty solid brass

SOLD 5 PER PACKAGE ONLY
24-102 Brass Coupling Nut **1.00**

BRASS FAUCET LOCKNUT

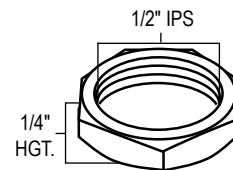

SOLD 5 PER PACKAGE ONLY
24-103 Brass Faucet Locknut **1.10**

PLASTIC COUPLING NUT

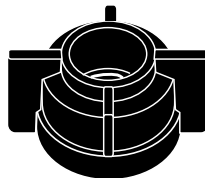

• Heavy gauge ABS plastic

SOLD 10 PER PACKAGE ONLY
24-099 Plastic Coupling Nut **.57¢**

CHROME PLATED BRASS BASIN AND BATH CHAIN WITH COUPLINGS



• 3/16" diameter chain
• 5 per bar coded display package
• Price per each

SOLD 5 PER PACKAGE ONLY
24-113 10" Basin Chain **.46¢**

CHROME PLATED SINK STRAINER

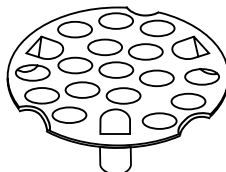

• 12 each per bar coded display box

52-134 1-5/8" OD Chrome **2.30**
52-133 1-7/8" OD Chrome **2.36**

STRAINER GASKET

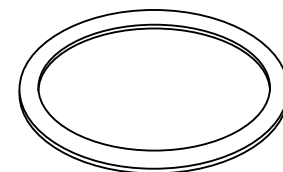

SOLD 5 PER PACKAGE ONLY
52-152 Fibre Gasket 4-1/4"OD x 3-3/8"ID x 1/8" thick. **.35¢**
52-153 Rubber Gasket 4-3/8"OD x 3-1/2"ID x 1/8" thick ... **.69¢**

USE YOUR CREDIT CARD AT TIME OF PURCHASE AND SAVE 2% ON ALL ORDERS, SAVE 5% ON ALL ORDERS OVER \$500 OR SAVE 10% ON ALL ORDERS OVER \$1000

FAX 1-800-982-5934 www.HODES CO .com PHONE 1-800-777-6500
226

SINK REPAIR

SINK CLIPS AND SCREWS



**FAUCETS AND
EXTERNAL TRIM**

HUDDY SINK CLIP SET

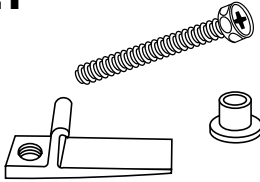

- Contains:
 • 1 - 24-082
 • 1 - 24-085
 • 1 - 24-081

24-080 Huddy Sink Clip Set **2.32**

PLASTIC SINK CAPS



SOLD 10 PER PACKAGE ONLY

24-081 Plastic Sink Caps **.46¢**

1-1/4" SINK SCREW

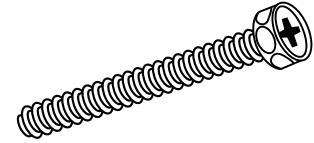

SOLD 10 PER PACKAGE ONLY

24-082 1-1/4" Sink Screw **1.00**

SELF RIMMING SINK SCREW

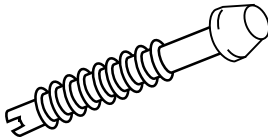

SOLD 10 PER PACKAGE ONLY

24-083 Self Rimming Screw **1.00**

ADJUSTABLE SINK CLIP SET

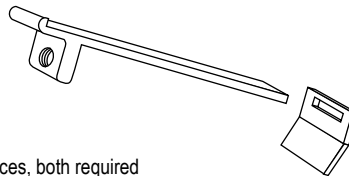

- 2 pieces, both required
- Used on tile counter tops

24-084 Adjustable Sink Clip Set **2.32**

SINK CLIP

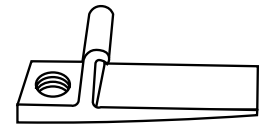

- 7/16" width

SOLD 10 PER PACKAGE ONLY

24-085 7/16" Wide Sink Clip **.93¢**

SINK CLIP

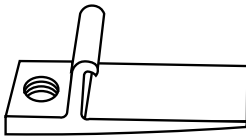

- 9/16" width

SOLD 10 PER PACKAGE ONLY

24-086 9/16" Wide Sink Clip **.93¢**

SINK CLIP FOR AMERICAN STANDARD

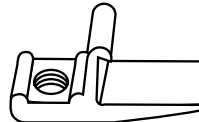

SOLD 10 PER PACKAGE ONLY

24-087 Generic Sink Clip **.93¢**

SINK CLIP FOR BRIGGS

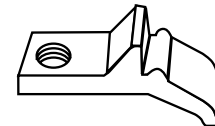

SOLD 10 PER PACKAGE ONLY

24-088 Generic Sink Clip **.93¢**

SINK CLIP FOR ELKAY WITH BOLT



SOLD 10 PER PACKAGE ONLY

24-089 Generic Sink Clip **.93¢**

SINK CLIP FOR KINKEAD

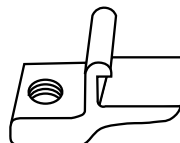

SOLD 10 PER PACKAGE ONLY

24-090 Generic Sink Clip **.93¢**

SINK CLIP FOR KINKEAD

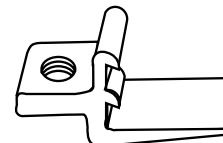

SOLD 10 PER PACKAGE ONLY

24-091 Generic Sink Clip **.93¢**

**USE YOUR CREDIT CARD AT TIME OF PURCHASE AND SAVE 2% ON ALL ORDERS,
SAVE 5% ON ALL ORDERS OVER \$500 OR SAVE 10% ON ALL ORDERS OVER \$1000**

**FAX
1-800-982-5934**

www.HODES CO.com
PROFFERED PLUMBING PRODUCTS

**PHONE
1-800-777-6500
227**

SINK CLIPS



ADVANTAGE™
COMMERCIAL HEAVY DUTY
8" REPLACEMENT
SWING SPOUT

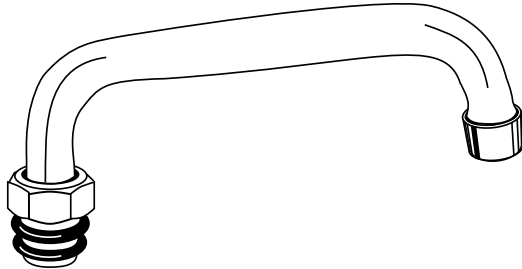

- NSF Certified
- Heavy chrome plated brass construction
- Fits Advantage™ Faucet #18-100, 18-101, 18-102, 18-103
- Interchangeable with other major brand commercial faucets
- Complies with all low lead requirements of NSF 61 and California proposition 65
- 1 per box - 6 per case

18-104 Genuine Advantage 8" Spout **17.68**

ADVANTAGE™
COMMERCIAL HEAVY DUTY
12" REPLACEMENT
SWING SPOUT

(062X)

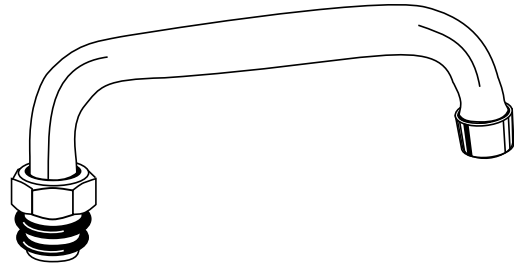

- NSF Certified
- Heavy chrome plated brass construction
- Fits Advantage™ Faucet #18-100, 18-101, 18-102, 18-103
- Interchangeable with other major brand faucets
- Complies with all low lead requirements of NSF 61 and California proposition 65
- 1 per box - 6 per case

18-106 Genuine Advantage 12" Spout **19.90**

ADVANTAGE™
COMMERCIAL HEAVY DUTY
14" REPLACEMENT
SWING SPOUT

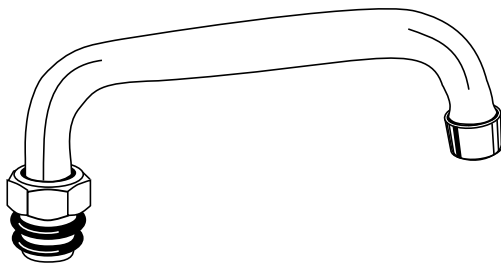

- NSF Certified
- Heavy chrome plated brass construction
- Fits Advantage™ Faucet #18-100, 18-101, 18-102, 18-103
- Interchangeable with other major brand faucets
- Complies with all low lead requirements of NSF 61 and California proposition 65
- 1 per box - 6 per case

18-107 Genuine Advantage 14" Spout **23.60**

ADVANTAGE™
COMMERCIAL HEAVY DUTY
18" REPLACEMENT DOUBLE JOINTED
SWING SPOUT

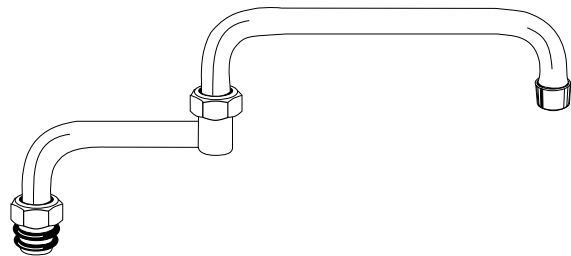

- NSF Certified
- Heavy chrome plated brass construction
- Replacement spout for Advantage™ Commercial Faucets
- Fits Advantage™ Faucet #18-101, 18-102, 18-103, 18-104
- Interchangeable with other major brand commercial faucets
- Complies with all low lead requirements of NSF 61 and California proposition 65
- 1 per box - 6 per case

18-108 Genuine Advantage 18" Spout **32.96**

ADVANTAGE™

**USE YOUR CREDIT CARD AT TIME OF PURCHASE AND SAVE 2% ON ALL ORDERS,
SAVE 5% ON ALL ORDERS OVER \$500 OR SAVE 10% ON ALL ORDERS OVER \$1000**

FAX 1-800-982-5934 www.HODES CO.com PHONE 1-800-777-6500
228 **HODES CO.** PROFFERED PLUMBING PRODUCTS

SINK SPOUTS



FAUCETS AND EXTERNAL TRIM

American KITCHENS (AK 5448) TUBE SPOUT

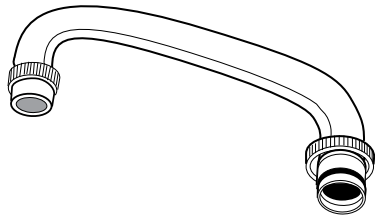

15-109 Genuine Spout **42.88**

For DELTA (RP5654) KITCHEN CHROME PLATED CAST SPOUT

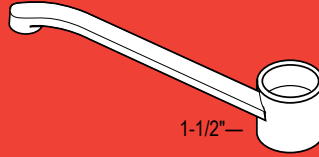

• For single handle kitchen faucets
22-711 Genuine Advantage 8" CP Cast Spout **9.40**

For PRICE PFISTER (920-242) KITCHEN CAST SPOUT

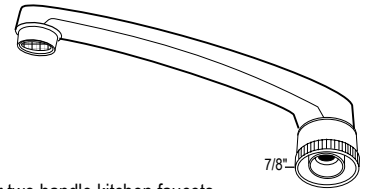

• For two handle kitchen faucets
22-763 Generic 8" CP Cast Spout **8.10**

For STERLING (2890) KITCHEN TUBE SPOUT

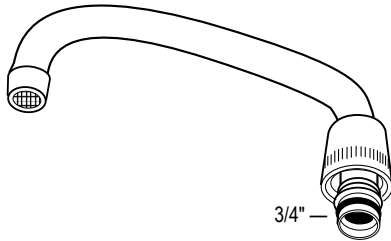

• For two handle kitchen faucets
22-705 Generic 8" CP Tube Spout **9.40**

STERLING (8364) KITCHEN TUBE SPOUT

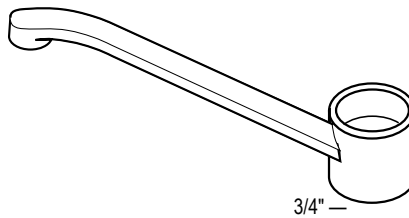

• For two handle kitchen faucets
22-700 Genuine 8" CP Tube Spout **23.60**

T&S (062X) SWING NOZZLES

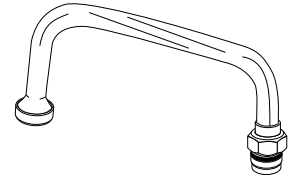

10-334 Genuine 12" Swing Nozzle **40.12**

CHICAGO FAUCETS (GN1AE3JKCP) SPOUT



18-014 Genuine Spout **41.62**

FIT-A-LOT PULLOUT KITCHEN HOSE KIT

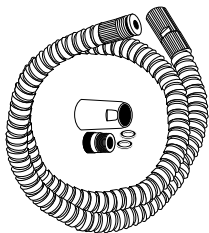

FITS:
• DELTA
• MOEN
• VALLEY
• KOHLER
• KWC

KIT INCLUDES NEW STYLE DELTA HOSE WITH DELTA HANDLE NUT AND 9/16-24 MALE THREAD END. ALSO INCLUDED IS A KWC HANDLE NUT AND MALE ADAPTER FOR KWC 5/8-20 MALE THREAD. TO USE FOR OLD STYLE MOEN OR KOHLER REMOVE YOUR OLD HANDLE NUT AND RE-USE

23-230 FIT-A-LOT Kitchen Hose Kit **35.21**

FIT-A-LOT PULLOUT KITCHEN HOSE KIT

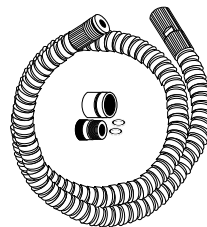

FITS
• GROHE
• PRICE
• PFISTER

KIT INCLUDES GROHE HOSE AND HANDLE NUT WITH 9/16-24 MALE THREADS. ALSO INCLUDED IS AND EXTRA HANDLE NUT FOR PRICE PFISTER AND MALE ADAPTER FOR PRICE PFISTER 9/16-18 MALE THREAD.

23-231 FIT-A-LOT Kitchen Hose Kit **35.21**

KITCHEN FAUCET PULLOUT SPRAYHEAD FITS MOST APPLICATIONS



• Rubber push button control
23-234 Generic Chrome Pullout Spray Head . **31.89**

USE YOUR CREDIT CARD AT TIME OF PURCHASE AND SAVE 2% ON ALL ORDERS, SAVE 5% ON ALL ORDERS OVER \$500 OR SAVE 10% ON ALL ORDERS OVER \$1000

FAX 1-800-982-5934 www.HODES CO.com PHONE 1-800-777-6500
PROFFERED PLUMBING PRODUCTS 229

SINK SPOUTS



**Kwik-Rinse™
SPRAY HEAD
AND HOSE**

(MR422-4)

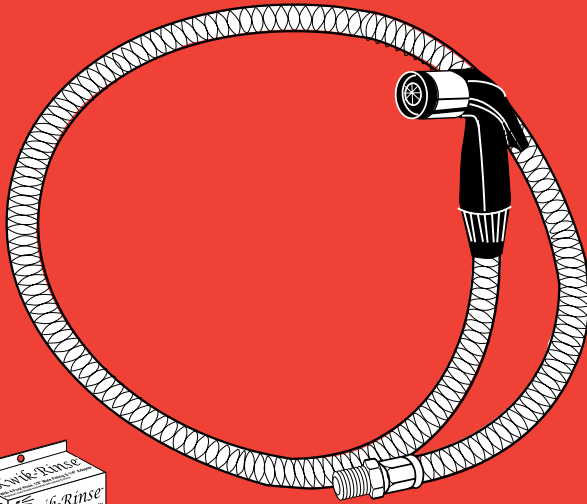

• 100% water and air tested before shipment

1 PER PACKAGE

23-260 Genuine Black Hose Assembly **7.05**
23-459 Genuine White Hose Assembly **9.41**

**Kwik-Rinse™
SPRAY HEAD**

(MR422)

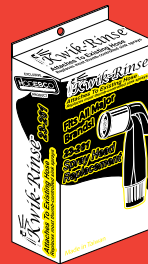

• 100% water and air tested before shipment

1 PER PACKAGE

23-261 Genuine Black Spray Head **5.86**
23-263 Genuine White Spray Head **7.05**

DIVERS/SRAYS



(RP6073)

**SPRAY
DIVERter**

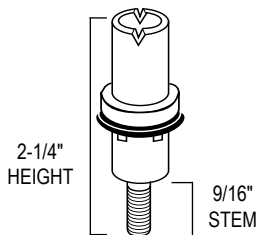

• For two handle faucets

23-450 Genuine Delta Diverter **9.06**



(RP320)

15/16"
HEIGHT

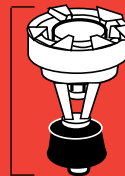

• For single lever faucets

SOLD 3 PER PACKAGE ONLY

23-172 Genuine Diverter **1.97**



(91192)

7/8"
HEIGHT



23-207 Genuine Spray Diverter **24.31**

**USE YOUR CREDIT CARD AT TIME OF PURCHASE AND SAVE 2% ON ALL ORDERS,
SAVE 5% ON ALL ORDERS OVER \$500 OR SAVE 10% ON ALL ORDERS OVER \$1000**

FAX 1-800-982-5934 www.HODES CO.com PHONE 1-800-777-6500
230 **HODES CO.** PREFERRED PLUMBING PRODUCTS

SPRING-FLO SLOTTED AERATORS



FAUCETS AND EXTERNAL TRIM

The Original
SPRING-FLO

**CHROME PLATED BRASS
COMBO MALE-FEMALE THREAD
DUAL SLOTTED
AERATOR**

THE ORIGINAL
AERATOR WITH
THREE BRASS
SCREENS SINCE
1938

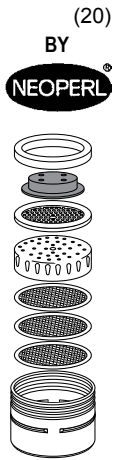
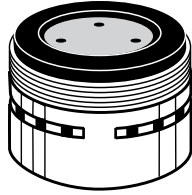
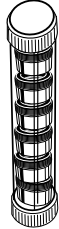

- (15/16" - 27 male thread or
55/64" - 27 female thread)
- 2.2 GPM (60 PSI)

SOLD 6 PER TUBE ONLY

24-154 CP Brass Aerator **2.85**

The Original
SPRING-FLO

**CHROME PLATED BRASS
REGULAR FEMALE THREAD
DUAL SLOTTED
AERATOR**

THE ORIGINAL
AERATOR WITH
THREE BRASS
SCREENS SINCE
1938

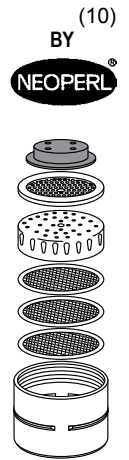
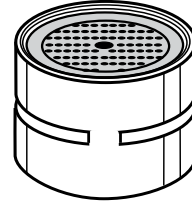
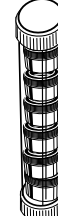

- Lo-flo disc
- (55/64" - 27 female thread)
- 2.2 GPM (60 PSI)

SOLD 6 PER TUBE ONLY

24-150 CP Brass Aerator **3.02**

The Original
SPRING-FLO

**CHROME PLATED BRASS
REGULAR MALE THREAD
DUAL SLOTTED
AERATOR**

THE ORIGINAL
AERATOR WITH
THREE BRASS
SCREENS SINCE
1938

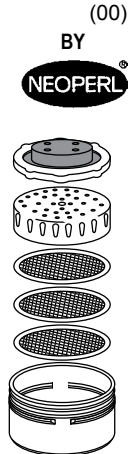
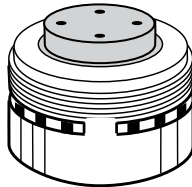

- (15/16" - 27 male thread)
- 2.2 GPM

SOLD 6 PER TUBE ONLY

24-152 CP Brass Aerator **3.02**

The Original
SPRING-FLO

**CHROME PLATED BRASS
SMALL FEMALE THREAD
DUAL SLOTTED
AERATOR**

THE ORIGINAL
AERATOR WITH
THREE BRASS
SCREENS SINCE
1938

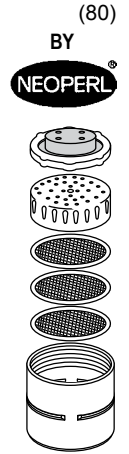
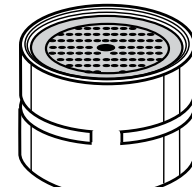

- (3/4" - 27 female thread)
- 2.2 GPM
- For Price Pfister

SOLD 6 PER TUBE ONLY

24-151 CP Brass Aerator **3.02**

The Original
SPRING-FLO

**CHROME PLATED BRASS
SMALL MALE THREAD
DUAL SLOTTED
AERATOR**

THE ORIGINAL
AERATOR WITH
THREE BRASS
SCREENS SINCE
1938

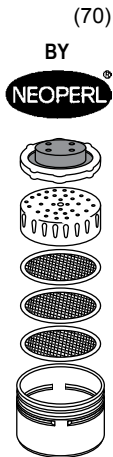
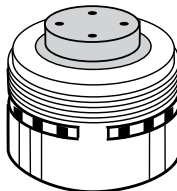

- (13/16" - 27 male
thread)
- 2.2 GPM

SOLD 6 PER TUBE ONLY

24-153 CP Brass Aerator **3.02**

**SNAP NIPPLE
(AERATING)**

LARGE DIAMETER NIPPLES
MEASURE 13/16" ACROSS

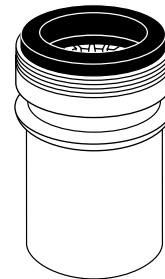

23-118 Regular Dual 15/16" and 55/64" Fitting Large Diameter Nipple
(Extra Long Deluxe Aerator) **3.86**

**USE YOUR CREDIT CARD AT TIME OF PURCHASE AND SAVE 2% ON ALL ORDERS,
SAVE 5% ON ALL ORDERS OVER \$500 OR SAVE 10% ON ALL ORDERS OVER \$1000**

FAX 1-800-982-5934 www.HODES CO.com PHONE 1-800-777-6500
PROFFERED PLUMBING PRODUCTS

FAUCETS AND EXTERNAL TRIM



SLOTLESS AERATORS

CHROME PLATED OR POLISHED BRASS DUAL THREAD COMBO SLOTLESS AERATOR

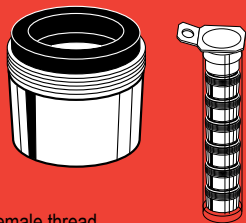

- Combo male-female thread
- (15/16" - 27 male thread or 55/64" - 27 female thread)
- 2.2 GPM (60 PSI)

SOLD 6 PER HANG TUBE ONLY

23-244 Generic CP Brass Aerator **1.05**

GENUINE COMPARE ERIC



The World Leader of Faucet Attachments, Providing Superior Quality Product to The Likes of American Standard, Delta, Kohler, Moen, Price Pfister (20)

CHROME PLATED COMBO SLOTLESS AERATOR

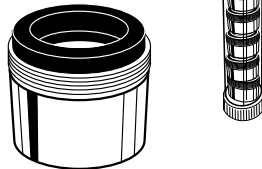

- Combo male-female thread
- (15/16" - 27 male thread or 55/64" - 27 female thread)



SOLD 6 PER TUBE ONLY

23-144 CP Brass Aerator (2.2 GPM-60 PSI) . **1.39**
23-148 CP Brass Aerator (.5 GPM) **NEW** **2.53**



The World Leader of Faucet Attachments, Providing Superior Quality Product to The Likes of American Standard, Delta, Kohler, Moen, Price Pfister (10)

CHROME PLATED REGULAR FEMALE THREAD SLOTLESS AERATOR

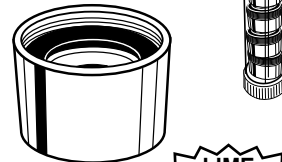

- Regular female thread
- (55/64" - 27 female thread)
- 2.2 GPM (60 PSI)

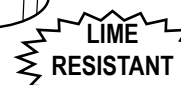

SOLD 6 PER TUBE ONLY

23-140 CP Brass Aerator **1.39**



The World Leader of Faucet Attachments, Providing Superior Quality Product to The Likes of American Standard, Delta, Kohler, Moen, Price Pfister (80)

CHROME PLATED SMALL FEMALE THREAD SLOTLESS AERATOR

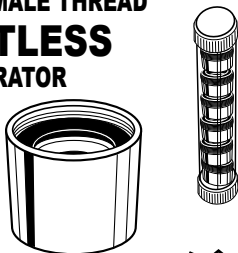

- Small female thread
- (3/4" - 27 female thread)
- 2.2 GPM (60 PSI)



SOLD 6 PER TUBE ONLY

23-141 CP Aerator **1.63**



The World Leader of Faucet Attachments, Providing Superior Quality Product to The Likes of American Standard, Delta, Kohler, Moen, Price Pfister (00)

CHROME PLATED REGULAR MALE THREAD SLOTLESS AERATOR

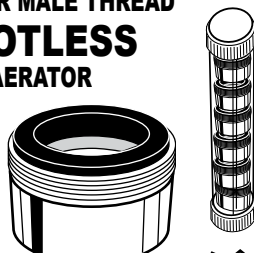

- Regular male thread
- (15/16" - 27 male thread)
- 2.2 GPM (60 PSI)



SOLD 6 PER TUBE ONLY

23-142 CP Brass Aerator **1.48**



The World Leader of Faucet Attachments, Providing Superior Quality Product to The Likes of American Standard, Delta, Kohler, Moen, Price Pfister (73)

CHROME PLATED SMALL MALE THREAD SLOTLESS AERATOR

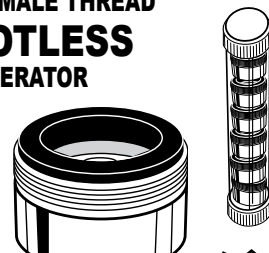

- (13/16" - 27 male thread)
- 2.2 GPM (60 PSI)

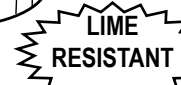

SOLD 6 PER TUBE ONLY

23-143 CP Brass Aerator **1.63**

SLOTLESS AERATORS

For CHICAGO FAUCET



- 2.2 GPM (60 PSI)
- 13/16" x 24

23-108 Generic E-3 2-Piece Aerator. **4.45**

GENUINE COMPARE ERIC



(E-3)

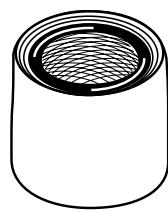

- 2.2 GPM
- 13/16" x 24

23-109 Genuine Female Thread E-3 Aerator. **14.78**

CHROME PLATED SELF-CLEANING AERATOR

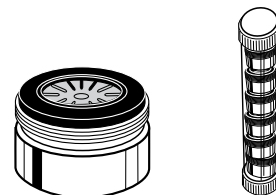

- Insta-clean self-cleaning
- Regular male thread
- (15/16" - 27 male thread)
- 2.2 GPM (60 PSI)



SOLD 6 PER TUBE ONLY

24-155 Generic CP Brass Aerator **2.08**

USE YOUR CREDIT CARD AT TIME OF PURCHASE AND SAVE 2% ON ALL ORDERS, SAVE 5% ON ALL ORDERS OVER \$500 OR SAVE 10% ON ALL ORDERS OVER \$1000

FAX 1-800-982-5934 www.HODES CO.com PHONE 1-800-777-6500
232 **HODES CO. PREFERRED PLUMBING PRODUCTS**

ADAPTERS



FAUCETS AND EXTERNAL TRIM

DELTA
FAUCET COMPANY
GENUINE PARTS

**CHROME PLATED BRASS
SPRAY 'ROUND
AERATOR**

(RP2189)

- Combo male or female thread fits most spouts
- Swivels 360°
- Twist aerator to the left and get a full no-splash stream
- Twist to the right and get a full, uniform spray
- Leave in the center position and receive a smooth combination of both the spray and stream
- 2.2 GPM at 60 PSI
- 1 per bar coded display package

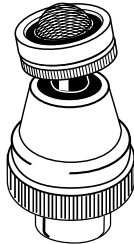

24-157 Genuine Spray 'Round Aerator..... **19.96**

**SWIVEL
AERATOR**

- Chrome spout connector
- Combo male-female thread
- Double ball joint
- Push-pull swing-n-spray
- 2.2 GPM
- (15/16" - 27 male thread or 55/64" - 27 female thread)

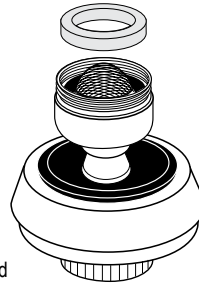

23-132 Chrome Plated Swivel Body..... **10.88**

23-146 White Swivel Body..... **9.98**

NEOPERL
CHROMED BRASS
ADAPTER

(339)

TOP: SMALL 13/16" MALE - 27 THREAD

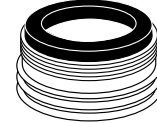

BOTTOM: FITS REGULAR FEMALE ATTACHMENT

23-121 CP Brass Adapter..... **3.49**

NEOPERL
CHROMED BRASS
ADAPTER

(349)

TOP: FEMALE 13/16" - 24 THREAD



BOTTOM: FITS REGULAR FEMALE THREAD

23-127 CP Brass Adapter..... **3.49**

NEOPERL
CHROMED BRASS
ADAPTER

(336)

TOP: REGULAR 15/16" MALE

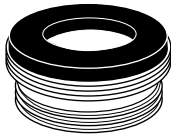

BOTTOM: FITS REGULAR FEMALE ATTACHMENT

23-120 CP Brass Adapter..... **3.49**

NEOPERL
CHROMED BRASS
ADAPTER

(348)

TOP: DUAL 15/16" MALE & 55/64" FEMALE



BOTTOM: FITS REGULAR FEMALE HOSE ATTACHMENT

23-133 CP Brass Adapter..... **3.49**

NEOPERL
CHROMED BRASS
SPECIAL ADAPTER

(331)

TOP: COMBO INTERNAL EXPANSION (FIT-ALL) THREAD



(23-131)

BOTTOM: FITS REGULAR FEMALE ATTACHMENT

23-131 CP Brass Special Adapter..... **7.05**

NEOPERL
CHROMED BRASS
ADAPTER

(335)

TOP: REGULAR 55/64" FEMALE
FITS REGULAR THREAD FAUCETS



BOTTOM: REGULAR 15/16" FEMALE
FITS REGULAR MALE ATTACHMENT

23-134 CP Brass Adapter..... **4.67**

NEOPERL
CHROMED BRASS
ADAPTER

(345)

TOP: 3/4" FEMALE HOSE THREAD



BOTTOM: FITS REGULAR FEMALE ATTACHMENT

23-129 CP Brass Adapter..... **4.67**

T&S ROSESPRAY



- 3/8" male thread

NEW

10-112 Rosespray..... **24.46**

**USE YOUR CREDIT CARD AT TIME OF PURCHASE AND SAVE 2% ON ALL ORDERS,
SAVE 5% ON ALL ORDERS OVER \$500 OR SAVE 10% ON ALL ORDERS OVER \$1000**

FAX 1-800-982-5934 www.HODES CO.com PHONE 1-800-777-6500
PROFFERED PLUMBING PRODUCTS 233

ADAPTERS



**CHROME PLATED ABS
LAVATORY POP-UP
ASSEMBLY**

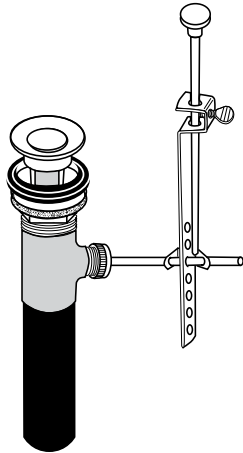

- Durable ABS construction
- Stainless steel trim
- 1 per bar coded display package
- 100 per case

11-153 ABS Pop-Up Assembly **5.03**

**CHROME PLATED BRASS
TWO PIECE
POP-UP WASTE
ASSEMBLY
WITH ROTATING CONNECTOR NUT**

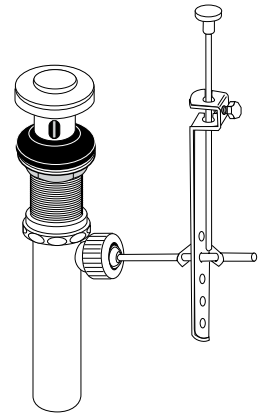

- Eliminates difficulty of positioning the linkage port alignment
- Quick & easy connection
- Top quality sealing washers to ensure leak free connections

11-159 Pop-Up Assembly **17.57**

**POLISHED BRASS
CAST BRASS
LAVATORY POP-UP
ASSEMBLY**

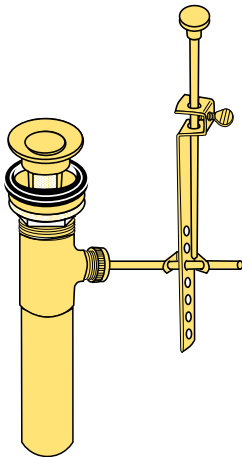

- Cast brass construction
- Polished brass trim
- 1 per bar coded heavy corrugated display box
- 50 per case

11-151 Polished Brass Lavatory Pop-Up Assembly **14.13**

**HEAVY PATTERN
CHROME PLATED
CAST BRASS
LAVATORY POP-UP
ASSEMBLY**

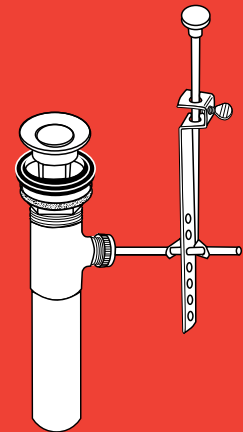

- Heavy gauge brass locknut
- Extra thick rubber washers
- Solid brass rod nut
- Chrome finish
- 1 per bar coded heavy corrugated display box
- 50 per case

11-152 Chromed Brass Pop-Up Assembly **11.12**
11-252 Deluxe Chromed Brass Pop-Up w/ Solid Brass Stopper(17 Gauge) .. **29.93**

POP-UP ASSEMBLIES

**DELTA
FAUCET COMPANY
CHROME PLATED
CAST BRASS
LAVATORY POP-UP
ASSEMBLY**

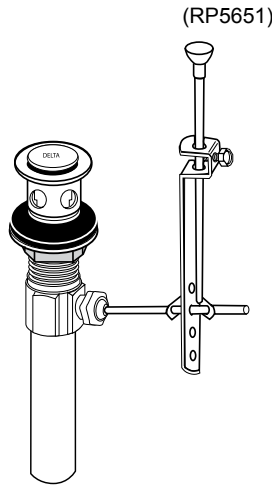

- Cast brass construction
- Chrome finish
- 1 per box

11-104 CP Lavatory Pop-Up Assembly **52.25**

**GERBER
CHROME PLATED
CAST BRASS
LAVATORY POP-UP
ASSEMBLY**

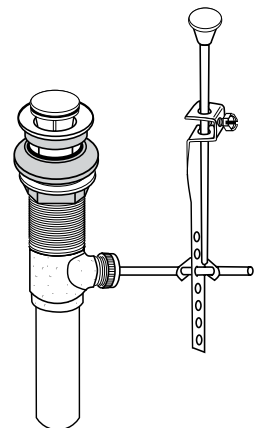

- Heavy gauge brass locknut
- Extra thick rubber washers
- Solid brass rod nut
- Chrome finish
- 1 per box

11-105 CP Lavatory Pop-Up Assembly **52.25**

**USE YOUR CREDIT CARD AT TIME OF PURCHASE AND SAVE 2% ON ALL ORDERS,
SAVE 5% ON ALL ORDERS OVER \$500 OR SAVE 10% ON ALL ORDERS OVER \$1000**

LAVATORY DRAIN ASSEMBLIES



FAUCETS AND EXTERNAL TRIM



HEAVY PATTERN CHROMED CAST BRASS TWO PIECE LAVATORY P.O. PLUG WITH STOPPER AND CHAIN

- 17 gauge tailpiece
- Rubber stopper
- Stainless steel beaded chain
- Chrome trim
- 1-1/4" diameter
- 8" long

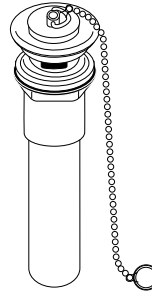

1 PER BOX

51-501 CP Brass P.O. Plug..... **9.26**

HEAVY PATTERN CHROMED CAST BRASS TWO PIECE PERFORATED GRID DRAIN

- 17 gauge tailpiece
- Thick rubber washer
- 1-1/4" diameter
- 8" long

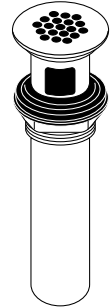

1 PER BOX

51-509 CP Brass P.O. Plug..... **10.99**

CHROMED BRASS ONE PIECE 5" LAVATORY P.O. PLUG WITH STOPPER AND CHAIN

- Solid brass body
- Rubber stopper
- Stainless steel beaded chain
- Chrome trim
- 1-1/4" diameter
- 5" long

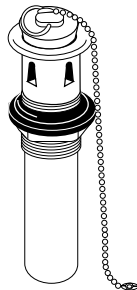

1 PER BOX

51-505 P.O. Plug Drain..... **10.19**

CHROMED BRASS TWO PIECE 6" LAVATORY P.O. PLUG WITH STOPPER AND CHAIN

- Solid brass body
- Rubber stopper
- Stainless steel beaded chain
- Chrome trim
- 1-1/4" diameter
- 6" long

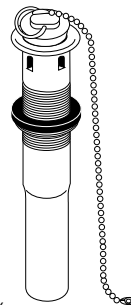

1 PER BOX

51-502 P.O. Plug Drain..... **15.33**

CHROMED BRASS TWO PIECE 8" LAVATORY P.O. PLUG WITH STOPPER AND CHAIN

- Solid brass body
- Rubber stopper
- Stainless steel beaded chain
- Chrome trim
- 1-1/4" diameter
- 8" long

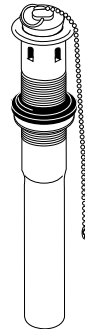

1 PER BOX

51-503 P.O. Plug Drain..... **15.33**

P.O. "PULL-UP" DRAIN

- Heavy Cast Brass Lift Plug
- Heavy Cast Brass Shoe
- Heavy 17 Gauge Tailpiece

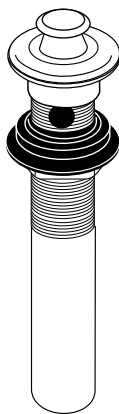

51-506 1-1/4" x 7" Lavatory Drain..... **32.20**

CHROMED CAST BRASS LAVATORY C.O. PLUG WITH STOPPER AND CHAIN

- Solid brass body
- Rubber stopper
- Stainless steel beaded chain
- Chrome trim
- 1-1/4" diameter
- 5" long

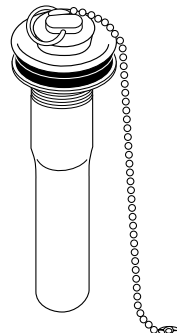

1 PER BOX

51-510 C.O. Plug Drain..... **9.35**

INDUSTRIAL SINK PLUG

- Cast brass with cast brass stopper
- 1" size with tailpiece

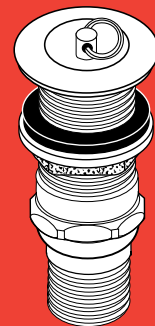

1 PER BOX

52-110 Industrial Sink Plug..... **12.21**

USE YOUR CREDIT CARD AT TIME OF PURCHASE AND SAVE 2% ON ALL ORDERS, SAVE 5% ON ALL ORDERS OVER \$500 OR SAVE 10% ON ALL ORDERS OVER \$1000

FAX 1-800-982-5934

www.HODES CO.com

PHONE 1-800-777-6500

FAUCETS AND EXTERNAL TRIM



POP-UP STOPPERS

For AMERICAN STANDARD

(70460)

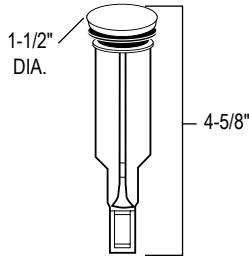

11-323 Generic CP Plastic Stopper **3.50**

DELTA
FAUCET COMPANY
GENUINE PARTS

(5648)

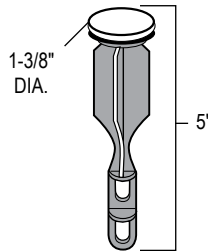

11-324 Genuine CP Plastic Stopper **10.60**

11-329 Generic CP Plastic Stopper **2.32**

For GERBER/SAYCO

(97-731)

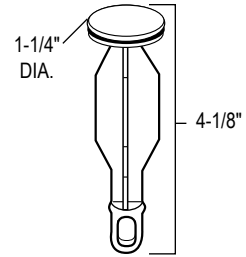

11-331 Generic CP Plastic Stopper **3.50**

For KOHLER

(40118)

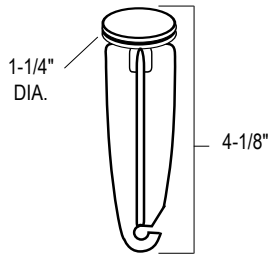

11-310 Generic CP Plastic Stopper **3.50**

For MOEN

(10709)

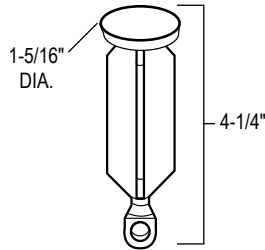

11-351 Generic CP Plastic Stopper **3.50**



PAY BY MAJOR CREDIT CARD WHEN YOU PLACE YOUR ORDER AND SAVE UP TO AN ADDITIONAL 10% OFF OUR ALREADY INDUSTRY-LOW PRICES!!

DELTA
FAUCET COMPANY
GENUINE PARTS

(RP12517)

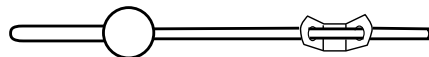

11-604 Genuine Ball Rod Assembly **8.90**

“FIT-ALL”

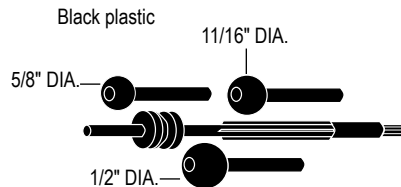

- 3 different sized balls fit one rod
- 5" lever end may be trimmed to length

11-624 Fit-All Pop-Up Rod Assembly **2.94**

LINKAGE POP-UP AND BALL ROD ASSEMBLY

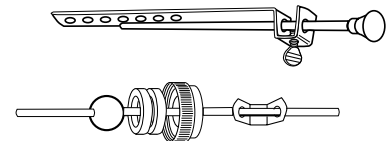

11-619 Linkage and Rod Assembly **4.40**

USE YOUR CREDIT CARD AT TIME OF PURCHASE AND SAVE 2% ON ALL ORDERS, SAVE 5% ON ALL ORDERS OVER \$500 OR SAVE 10% ON ALL ORDERS OVER \$1000

FAX 1-800-982-5934 www.HODESCO.com PHONE 1-800-777-6500
236 **HODESCO** PREFERRED PLUMBING PRODUCTS

FAUCET REBUILD KITS

PACKED IN HEAVY CORRUGATED BOXES WITH ILLUSTRATED LABELS



FAUCETS AND EXTERNAL TRIM

For AMERICAN STANDARD

LAVATORY & KITCHEN

Includes internal & external repairs
Chrome plated trim
One complete set per package includes:

- 27-380 seats
- 28-149R&L stems
- 21-516 locknuts
- 23-244 aerator
- 29-415 handles

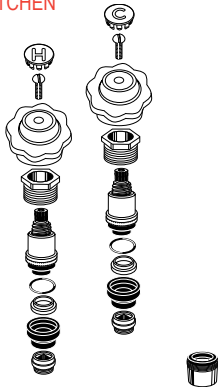

HERITAGE/AQUASEAL

22-871 Generic Rebuild Kit **17.63**

For AMERICAN STANDARD

TUB AND SHOWER

Includes internal and external repairs
1 set per bar coded display box includes:

- 28-705R stems
- 28-929D stem
- 29-418D handle
- 29-418 handle kit
- 23-282 sleeves
- 23-277 escutcheons
- 27-382 seats

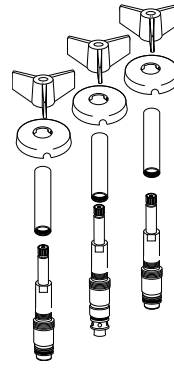

COLONY

22-939 Trim and Rebuild Kit **72.24**

For CENTRAL BRASS

LAVATORY & KITCHEN

Includes internal & external repairs
Chrome plated trim
One complete set per package includes:

- 27-354 faucet seats
- 28-040R&L stems
- 29-491 handle kit
- 23-143 aerator

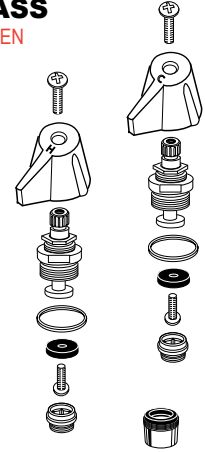

22-881 Generic Rebuild Kit **14.05**

For CENTRAL BRASS

TUB & SHOWER

Chrome plated handles
Chrome plated trim
Includes:

- 27-344 faucet seats
- 28-700R stems
- 23-890 escutcheons
- 29-493 handle kit
- 29-493D handle
- 27-434 seat
- 28-806D stem
- 23-551 nipples

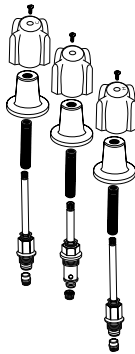

OLD STYLE

22-900 3 Handle Rebuild Kit as Shown **50.19**
22-920 2 Handle Rebuild Kit (Less Diverter) **38.33**



GENUINE PARTS SINGLE HANDLE TUB & SHOWER REBUILD KIT

Kit includes:

- 23-436 springs
- 23-433 seats
- 26-331 ball
- 21-150 wrench
- 23-423 packing
- 23-421 cam
- 13-408 escutcheon
- 21-169 cap
- 21-403 lever handle
- 23-303 ring

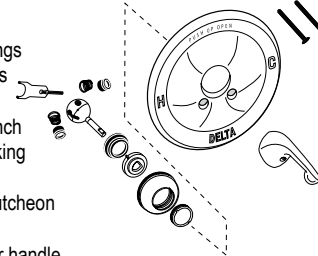

23-940 Genuine Rebuild Kit **58.80**



GENUINE PARTS LAVATORY & KITCHEN

Includes internal & external repairs
Chrome plated trim
One complete set per package includes:

- 26-437 cartridges
- 23-437 seats
- 23-436 springs
- 24-155 aerator
- 23-314 screws
- 22-536 handles

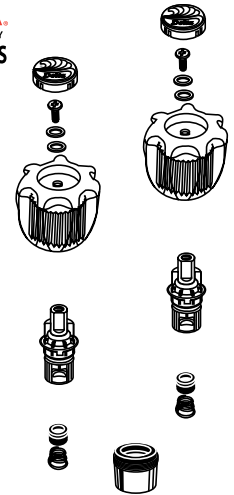

22-882 Genuine Rebuild Kit **21.24**

For ELJER

TUB & SHOWER

Chrome plated handles
Chrome plated trim
Kit includes:

- 27-452 seats
- 28-646R stems
- 23-290 escutcheons
- 29-559 handles
- 29-559D handle
- 28-643D stem

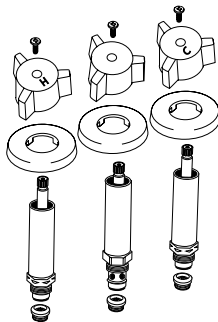

22-901 3 Handle Rebuild Kit as Shown **61.19**

For GERBER

LAVATORY & KITCHEN

Includes internal & external repairs
Chrome plated trim
One complete set per package includes:

- 27-386 seats
- 28-059L&R stem
- 29-576 handles
- 23-244 aerator

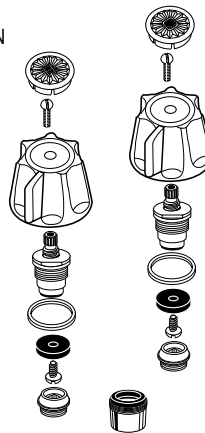

22-887 Generic Rebuild Kit **11.65**

For GERBER

TUB & SHOWER

Chrome plated handles
Chrome plated trim
Includes:

- 27-386 seats
- 28-695R stems
- 28-723D Div Stem
- 23-211 sleeves
- 23-299 escutcheons
- 29-572 handles
- 29-572D handle

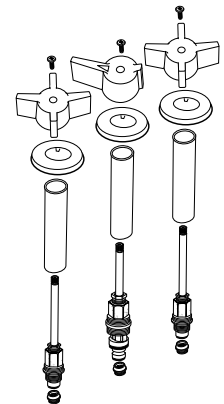

22-902 3 Handle Rebuild and Handle Trim. **44.38**

USE YOUR CREDIT CARD AT TIME OF PURCHASE AND SAVE 2% ON ALL ORDERS, SAVE 5% ON ALL ORDERS OVER \$500 OR SAVE 10% ON ALL ORDERS OVER \$1000

FAX
1-800-982-5934

www. **HODES CO.** .com
PROFERRED PLUMBING PRODUCTS

PHONE
1-800-777-6500

FAUCETS AND EXTERNAL TRIM



FAUCET REBUILD KITS

PACKED IN HEAVY CORRUGATED BOXES WITH ILLUSTRATED LABELS

For GERBER TUB & SHOWER

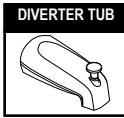

- Chrome plated handles
- Chrome plated trim
- Chrome plated brass shower arm & head

Includes:

- 27-386 seats
- 28-695R stems
- 28-723D stem
- 29-573 handles
- 29-573D handle
- 23-211 sleeves
- 23-299 escutcheons
- 13-141 showerhead
- 13-109 shower arm
- 13-210 flange
- 13-905 spout

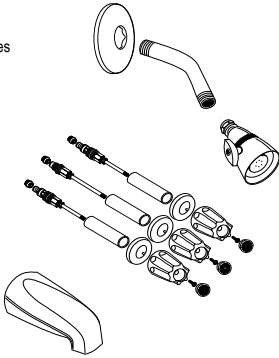

22-942 3 Handle Complete Renew(shown) . **66.68**
22-903 Less Tub Spout & Shower Head/Flange . **50.07**

For KOHLER TUB & SHOWER

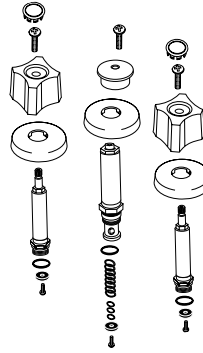

- Chrome plated handles
- Chrome plated trim

Includes:

- 29-870 handles
- 23-198 escutcheons
- 28-632D stem
- 28-634R&L stems
- 29-871D handle
- 27-306 seats

22-915 3 Handle Rebuild and Handle Trim(shown) . **98.74**
22-906 Less Diverter Components **58.70**

For MOEN SINGLE HANDLE VALVE TRIM & REBUILD KIT

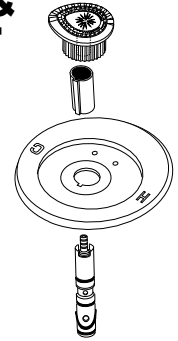

- Includes both internal & external repairs
- Chrome plated trim
- 1 set per bar coded display box

includes:

- 26-400 cartridge
- 13-424 escutcheon
- 23-264 sleeve
- 21-653 handle

21-230 Generic Rebuild Kit **40.82**

CHATEAU

For PRICE PFISTER LAVATORY & KITCHEN

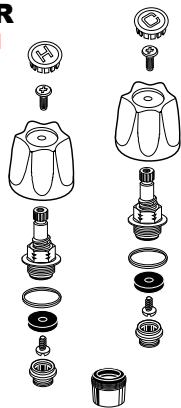

- Includes internal & external repairs
 - Chrome plated trim
- One complete set per package

includes:

- 27-340 seats
- 28-155R stems
- 29-700 handles
- 23-244 aerator

22-892 Generic Rebuild Kit **11.14**

VERVE

For PRICE PFISTER TUB & SHOWER

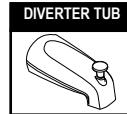

- Chrome plated handles
- Chrome plated trim
- Chrome plated brass shower arm & head

Includes:

- 27-338 seats
- 28-660R stems
- 28-823D stem
- 29-702 handles
- 29-702D handles
- 23-497 adapters
- 23-280 nipples
- 23-195 escutcheons
- 13-141 showerhead
- 13-109 shower arm
- 13-210 flange
- 13-214 shower arm flange
- 13-905 tub spout

22-947 3 Handle Complete Renew(shown) . . **69.16**
22-957 2 Handle Less Diverter Trim **60.41**
22-907 3 Handle Less Tub Spout & Shower Head/Flange . **35.22**

VERVE

For PRICE PFISTER TUB & SHOWER

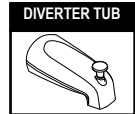

- Chrome plated handles
- Chrome plated trim
- Chrome plated brass shower arm & head

Includes:

- 13-905 tub spout
- 22-693 handles
- 22-693D handle
- 23-195 escutcheons
- 23-497 adapters
- 23-280 nipples
- 28-659R stems
- 28-823D stem
- 27-338 seats
- 13-141 shower head
- 13-109 shower arm
- 13-210 flange

22-940 3 Handle Complete Renew(shown) . **43.62**
22-909 Less Tub Spout & Shower Head/Flange . **38.61**

WINDSOR

REBUILD KITS

For SAYCO TUB & SHOWER

- Chrome plated handles
- Chrome plated trim
- Chrome plated brass shower arm & head

Includes:

- 23-214 sleeves
- 23-212 escutcheons
- 13-141 showerhead
- 27-372 seats
- 28-637R stems
- 28-738D stem
- 29-748 handles
- 13-109 shower arm
- 13-214 shower arm flange
- 13-210 flange
- 13-905 tub spout

22-941 3 Handle Complete Renew(shown) . . **64.65**
22-911 3 Handle Less Tub Spout & Shower Head/Flange . **54.23**
22-931 2 Handle Less Diverter, Tub Spout & Shower Head Arm/Flange . **34.26**

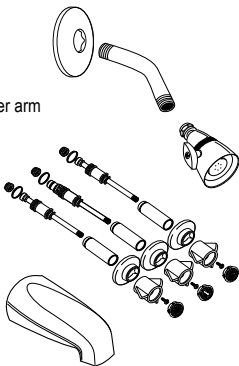

For STERLING TUB & SHOWER

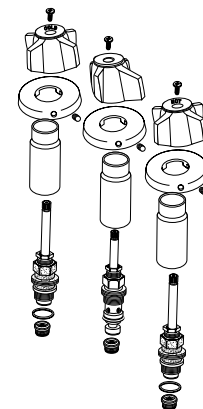

- Chrome plated handles
- Chrome plated trim

Includes:

- 23-996 sleeves
- 29-788 handles
- 29-788D handle
- 27-342 seats
- 28-645R stems
- 28-650D stem
- 23-199 escutcheons

22-912 3 Handle Rebuild and Handle Trim . . **49.90**

For UNION BRASS TUB & SHOWER

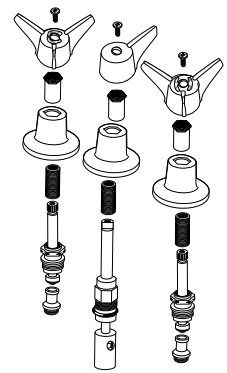

- Chrome plated handles
- Chrome plated trim

Includes:

- 27-489 seats
- 28-550R&L stems
- 23-990 escutcheons
- 23-994 nipples
- 23-998 sleeves
- 29-829D handle
- 29-829 handles
- 20-821 handle screws
- 28-553D stem & bonnet nut

22-914 3 Handle Rebuild and Handle Trim . . **69.71**

USE YOUR CREDIT CARD AT TIME OF PURCHASE AND SAVE 2% ON ALL ORDERS, SAVE 5% ON ALL ORDERS OVER \$500 OR SAVE 10% ON ALL ORDERS OVER \$1000

FAX 1-800-982-5934 www.HODES CO.com PHONE 1-800-777-6500
 238 **HODES CO.** PREFERRED PLUMBING PRODUCTS

TUB SPOUTS



**FAUCETS AND
EXTERNAL TRIM**

CHROMED DIE CAST PLAIN TUB SPOUT

1/2" FIP
(NOSE)

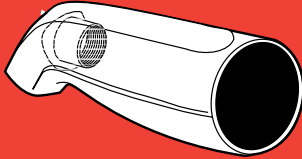

• One per heavy corrugated box

13-905 CP Die Cast Tub Spout **3.53**

CHROMED BRASS PLAIN TUB SPOUT

1/2" FIP
(NOSE)

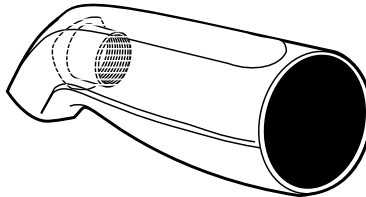

• One per heavy corrugated box

13-104 CP Brass Tub Spout **24.41**

CHROMED DIE CAST PLAIN TUB SPOUT

WITH
SET SCREW

1/2" CC
SLIP INLET
(BACK)

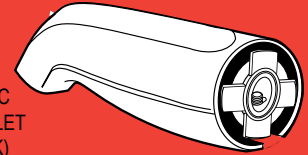

• One per heavy corrugated box

13-933 CP Plain Tub Spout **6.67**

CHROMED DIE CAST DIVERTER TUB SPOUT

ADJUSTABLE
FIT

1/2" FIP
WITH
BUSHING

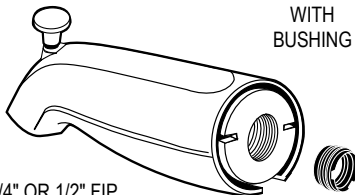

3/4" OR 1/2" FIP
(BACK)

• One per heavy corrugated box

13-963 CP Diverter Tub Spout **9.40**

CHROMED BRASS DIVERTER TUB SPOUT

1/2" FIP
WITH
BUSHING

3/4" OR 1/2" FIP
(BACK)

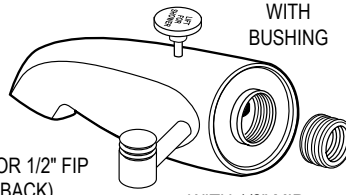

WITH 1/2" MIP
SIDE TAPPING

• One per heavy corrugated box

13-969 CP Diverter Tub Spout **24.46**



(RP17453)

PULLDOWN DIVERTER SPOUT

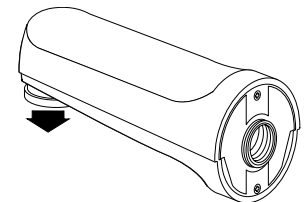

- 5-1/4" long
- Pull down to divert
- For 1/2" CWT or 1/2" IPS

13-140 Genuine Diverter Spout **33.20**

1-4-ALL UNIVERSAL SPOUT ADJUSTABLE FRONT

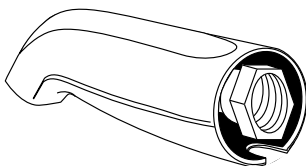

- Fully universal and adjustable
- Adjustable for various nipple lengths
- Fits 1/2" or 3/4" pipe nipples & slip-fit on 5/8" tube
- Designed to be error-free on installation leaking problems
- Simple and easy to install

13-949 Tub Spout **15.11**

CHROME PLATED TUB SPOUT

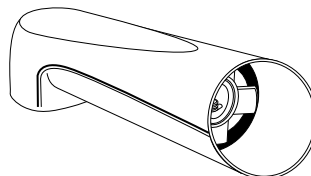

- 7" spout
- Slip fit 5/8"
- OD copper tube

13-960 Tub Spout **17.69**

CHROME PLATED EXTRA LONG 7" DIVERTER TUB SPOUT

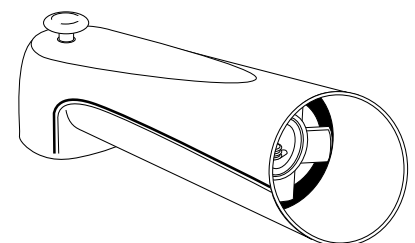

- Slip fit 5/8"
- 7" long spout
- OD copper tube

13-961 CP Diverter Tub Spout **20.06**

TUB SPOUTS

**USE YOUR CREDIT CARD AT TIME OF PURCHASE AND SAVE 2% ON ALL ORDERS,
SAVE 5% ON ALL ORDERS OVER \$500 OR SAVE 10% ON ALL ORDERS OVER \$1000**

**FAX
1-800-982-5934**

www.HODES CO.com
PROFFERED PLUMBING PRODUCTS

**PHONE
1-800-777-6500
239**

**FAUCETS AND
EXTERNAL TRIM**



TUB SPOUTS

**CHROMED DIE CAST
DIVERTER
TUB SPOUT**

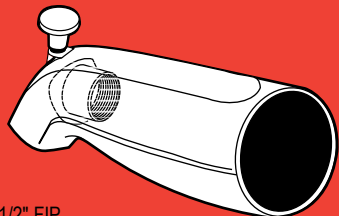

1/2" FIP
(NOSE)

One per heavy corrugated box

13-932 CP Diverter Tub Spout **7.09**
13-934 CP Brass Diverter Tub Spout **33.31**

**POLISHED BRASS DIE CAST
DIVERTER
TUB SPOUT**

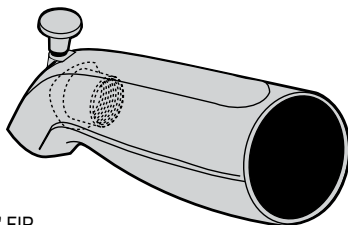

1/2" FIP
(NOSE)

Polished brass finish

One per heavy corrugated box

13-732 PB Diverter Tub Spout **13.63**

FIVE YEAR WARRANTY
(1010L)



**CHROME PLATED ZINC
HAND HELD SHOWER
ADD-A-SHOWER
DIVERTER
TUB SPOUT**

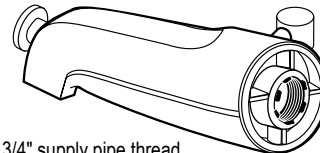

• Fits 1/2" or 3/4" supply pipe thread
• 1 per bar coded display package

13-333 Diverter Tub Spout **56.34**

**CHROMED DIE CAST
DIVERTER
TUB SPOUT**

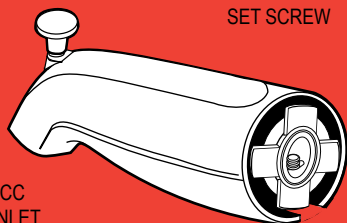

WITH
SET SCREW

1/2" CC
SLIP INLET
(BACK)

One per heavy corrugated box

13-908 CP Diverter Tub Spout **9.38**

**POLISHED BRASS
DIVERTER
TUB SPOUT**

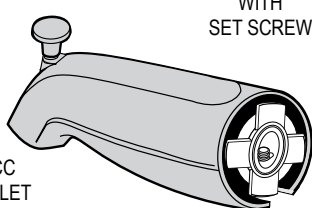

WITH
SET SCREW

1/2" CC
SLIP INLET
(BACK)

Polished brass finish

One per heavy corrugated box

13-708 PB Diverter Tub Spout **18.84**

**CHROMED DIE CAST
DIVERTER
TUB SPOUT**

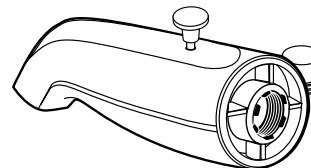

CHROMED
ZAMAC SPOUT
WITH 1/2" MIP SIDE TAPPING
AND 1/2" FIP (BACK)

• One per heavy corrugated box

13-974 CP Diverter Tub Spout **11.52**

TUB SPOUTS

**CHROMED BRASS
ADD-A-SHOWER
TUB SPOUT**

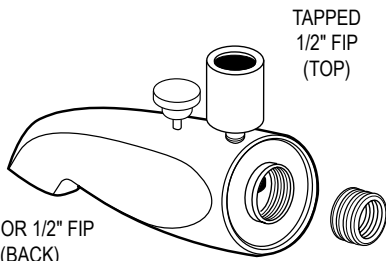

TAPPED
1/2" FIP
(TOP)

3/4" OR 1/2" FIP
(BACK)

• One per heavy corrugated box

14-106 Add-A-Shower Tub Spout **21.33**

**CHROMED DIE CAST
DIVERTER
TUB SPOUT**

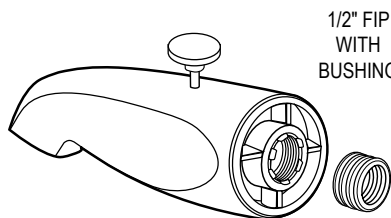

1/2" FIP
WITH
BUSHING

3/4" OR 1/2" FIP
(BACK)

• One per heavy corrugated box

13-907 CP Diverter Tub Spout **5.80**

**CHROMED BRASS
DIVERTER
TUB SPOUT**

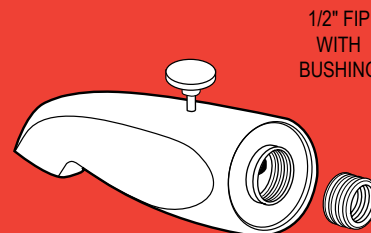

1/2" FIP
WITH
BUSHING

3/4" OR 1/2" FIP
(BACK)

• One per heavy corrugated box

13-903 CP Diverter Tub Spout **27.16**
13-964 CP Tub Spout (No Diverter) **11.56**

**USE YOUR CREDIT CARD AT TIME OF PURCHASE AND SAVE 2% ON ALL ORDERS,
SAVE 5% ON ALL ORDERS OVER \$500 OR SAVE 10% ON ALL ORDERS OVER \$1000**

**FAX
1-800-982-5934**

www.HODES CO.com



**PHONE
1-800-777-6500**

TUB DRAINS



FAUCETS AND EXTERNAL TRIM

**FOR SAYCO
CHROME PLATED
HEAVY CAST BRASS
LIFT AND TURN
ASSEMBLY
COMPLETE**

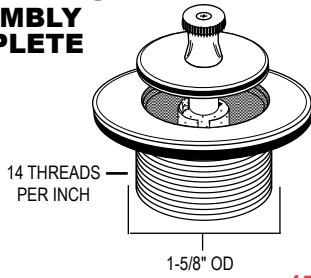

59-574 Drain Assembly..... **17.72**

**COARSE THREAD
CHROMED ZINC
LIFT & TURN DRAIN
ASSEMBLY
COMPLETE**

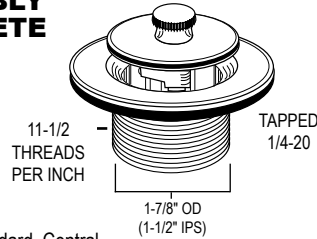

• For Am. Standard, Central, Gerber, Price Pfister
59-578 Drain Assembly..... **11.76**

**FINE THREAD
CHROMED BRASS
TIP TOE DRAIN
STOPPER**

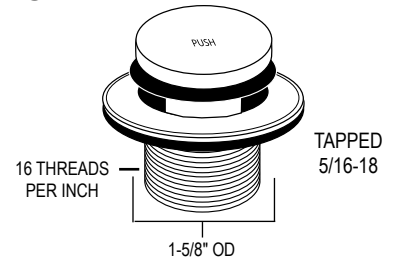

59-601 Drain Assembly..... **9.38**

**COARSE THREAD
CHROMED BRASS
LIFT & TURN DRAIN
ASSEMBLY
COMPLETE**

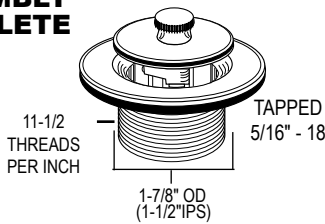

• For Am. Standard, Central, Gerber, Price Pfister
59-570 Drain Assembly..... **11.03**

**FINE THREAD
CHROMED BRASS
LIFT & TURN DRAIN
ASSEMBLY
COMPLETE**

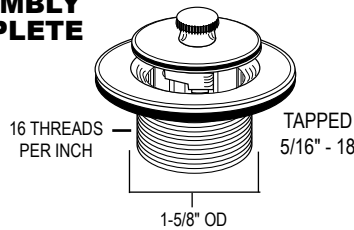

• For Crane, Eljer, Union and Watco
59-571 Drain Assembly..... **11.21**

**COARSE THREAD
BRASS
ADAPTER**

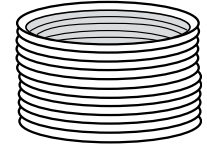

• 7/8" HGT.
• 1-7/8" O.D. – 11-1/2 T.P.I.
• 1-9/16" I.D. – 16 T.P.I.
• Adapts fine thread to coarse & vice versa
53-136 Adapter..... **5.46**

**FIT-ALL
FLIP-IT DRAIN
STOPPER
COMPLETE**

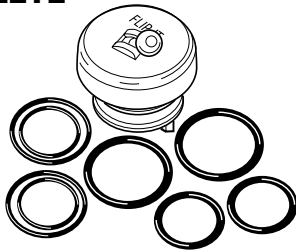

53-134 Flip-it Stopper..... **7.08**

**For
STERLING**

(00A8179)

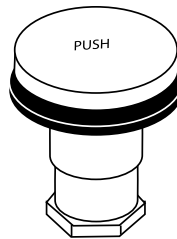

• Tiptoe stopper cartridge with 5/16" stem
59-525 Generic Tiptoe Stopper..... **2.33**

**For
STERLING**

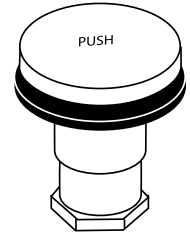

• Tiptoe stopper cartridge with 3/8" stem
59-555 Generic Tiptoe Stopper..... **2.33**



• Tiptoe stopper rubber gasket
SOLD 5 PER PACKAGE ONLY
59-526 Generic Gasket **1.18**

**GERBER
(OTHERS)**

(91-292)

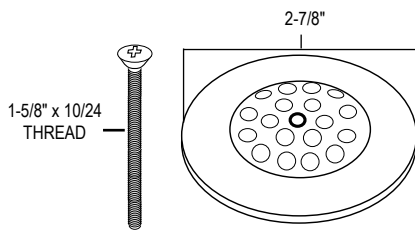

• Tub shoe strainer and screw
53-122 Strainer & Screw..... **2.20**

**STAINLESS STEEL
SNAP-IN GRILLS**

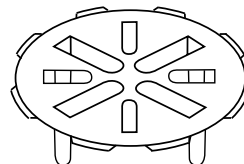

• Heavy gauge
53-210 For 2" Pipe–3" Dia..... **4.68**
53-211 For 3" Pipe–4" Dia..... **5.86**
53-212 For 4" Pipe–5" Dia..... **7.74**

**WASTE SHOE
WITH STRAINER**

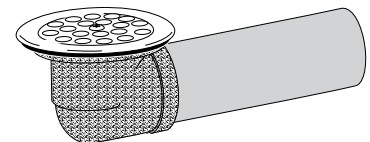

• 1-1/2" rough brass - fine thread
• With domed grid strainer
53-125 1/2" Waste Shoe Assembly..... **23.60**

**USE YOUR CREDIT CARD AT TIME OF PURCHASE AND SAVE 2% ON ALL ORDERS,
SAVE 5% ON ALL ORDERS OVER \$500 OR SAVE 10% ON ALL ORDERS OVER \$1000**

**FAX
1-800-982-5934**

www.HODESCO.com
PROFFERED PLUMBING PRODUCTS

**PHONE
1-800-777-6500
241**

TUB DRAINS



GENERAL PURPOSE PVC WITH STAINLESS STEEL DRAIN

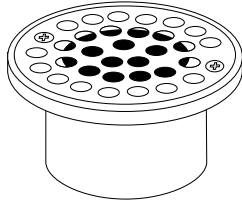

- Fits over 2" schedule 40 DWV pipe or inside 3" schedule 40 DWV pipe

53-282 2"-3" PVC Drain **7.68**

SOLVENT WELD WITH STAINLESS STEEL STRAINER SHOWER DRAIN

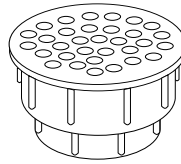

- Use with fiberglass bases
- Male strainer unit installs from top side of shower base into the female half underneath
- Outlet welds over 2" sch. 40 pipe for full flow

53-285 2" PVC Drain **7.68**

SHOWER PAN DRAIN



NEW

53-288 Shower Pan Drain **10.15**
53-289 Shower Pan Drain with Metal Rim ... **10.50**

PVC SHOWER DRAIN

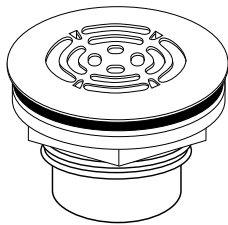

- Combo solvent or no-caulk snap-in grill

53-284 2" Shower Drain **17.58**

NO CAULK SHOWER DRAIN

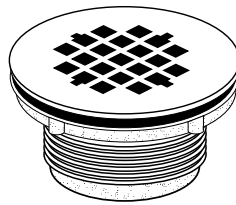

- 4-1/4" stainless steel grill with neoprene inlet slip connection

53-202 2" Inlet Brass Body **22.15**

NO CAULK SHOWER DRAIN

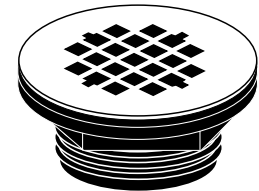

- 4-1/4" stainless steel grill with neoprene inlet slip connection

53-203 2" Inlet Plastic Body **12.25**

2" PULL TIGHT ABS SHOWER DRAIN



- Allows for extremely easy one-person shower drain installation
- All installation is done from the top
- Unique pull tight design
- Fits 2" sch. 40 PVC (53-600) or ABS pipe (53-601)
- Being able to install with one person and tighten from inside shower stall saves time and money
- Great for repair and new construction

53-600 Shower Drain Sch. 40 PVC **17.42**
53-601 Shower Drain ABS **NEW 17.42**

JACKRABBIT™



- 2" No-caulk connection works with ABS or PVC pipe.
- Unique design makes installation easier when workspace is limited.
- Uses "jacking bolts" to secure the drain to the shower module floors or bases.
- 4-1/4" stainless steel snap-in strainer.

53-408 JackRabbit™ Shower Drain **NEW 34.99**

SHOWER DRAINS



SHOWER DRAIN



- 100% Brass with stainless steel components
- Reduces installation time to 1 man and 45 minutes.
- Produces increased profitability
- Makes a very difficult job extremely simple

53-405 Shower Drain **NEW 36.67**



SHOWER DRAIN



- 100% Brass with stainless steel components
- Reduces installation time to 1 man and 45 minutes.
- Produces increased profitability
- Makes a very difficult job extremely simple

53-406 Shower Pan Drain with Metal Rim . . **NEW 42.25**



SHOWER DRAIN



- 100% Brass with stainless steel components
- Produces increased profitability
- Makes a very difficult job extremely simple

53-407 Shower Pan Drain with Metal Rim . . **NEW 66.80**

USE YOUR CREDIT CARD AT TIME OF PURCHASE AND SAVE 2% ON ALL ORDERS, SAVE 5% ON ALL ORDERS OVER \$500 OR SAVE 10% ON ALL ORDERS OVER \$1000

BATH ACCESSORIES



FAUCETS AND EXTERNAL TRIM

TUB TRIM KIT

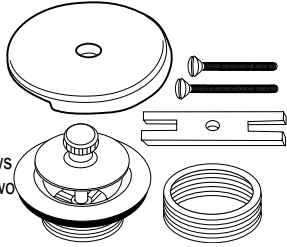

- Adapter bar allows replacement of two screw face plate
- Fits almost all installed tub drains

53-140 Chrome Plated Trim Kit (Lift & Turn) **28.16**

53-128 Chrome Plated Trim Kit (Push/Pull) **33.45**

53-928 Polished Brass Trim Kit (Push/Pull) **64.65**

PARTS ONLY

53-137 Push-Pull Waste Assembly **16.48**

53-136 Coarse Thread Adapter **5.46**

OFFSET BATH SUPPLIES FOR LEG TUB

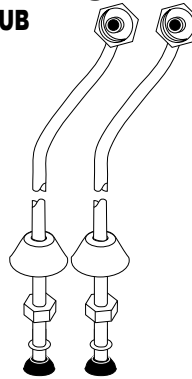

- Seamless brass annealed tube 1/2" OD x 21"
- Long polished chrome 16 gauge, 1/2" IPS nut to floor
- Furnished complete as shown

1 PAIR PER BOX

32-270 Pair Offset Supplies **16.33**

36-904 Top Supply Washer Only **NEW .17¢**

CAST SATIN BRASS BATH COUPLINGS

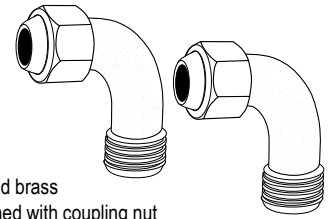

- Cast red brass
- Furnished with coupling nut
- Ground joint nose
- 1/2" MIP X 3/4" FIP Nut

24-104 Pair of Bath Couplings **6.75**

PLUNGER LINKAGE ASSEMBLY



NEW

59-606 Plunger Linkage Assembly **20.04**

"CATCH-ALL" FLOOR HAIR TRAP DRAIN STRAINER

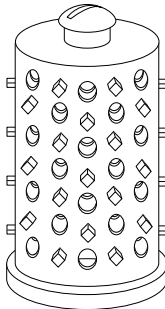

- For 2" shower floor drainpipe
- White plastic
- Designed with protuberances intended to trap hair from slipping into the drain
- Also prevents any other objects from running down the drainpipe
- Best protection for the drainpipe
- Prevents clogging
- Eliminates the use of chemicals that can be hard on the environment
- Easy to install

53-240 Drain Strainer **12.83**

SOLID BRASS TWIN ELL

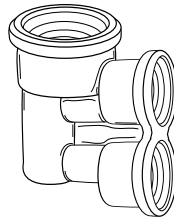

13-101 Twin Ell **5.59**

UNIVERSAL BRASS TUB DRAIN BUCKET

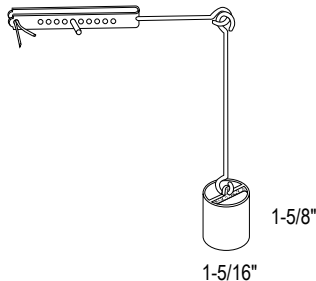

- Bucket is 1-5/16" O.D. and 1-5/8" high
- For waste and overflows

59-605 Universal Brass Bucket **4.71**

BRASS ADJUSTABLE INTERNAL WIRES FOR TRIP WASTE & OVERFLOW

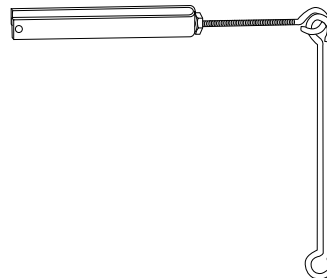

53-121 Trip W & O Wires **11.78**

LOCKING SHOWER ARM ELL

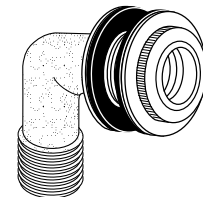

- "Locks" the shower assembly to the wall & eliminates vibration

12-186 Shower Arm Ell **6.60**

CELCON TUB SPOUT BUSHING

ADAPTS 3/4" TO 1/2" FIP



SOLD IN PACKAGE QTY ONLY

75-752 Plastic Bushing Only (5) **.28¢**

75-751 Brass Bushing Only (1) **1.73**

BATH ACCESSORIES

USE YOUR CREDIT CARD AT TIME OF PURCHASE AND SAVE 2% ON ALL ORDERS, SAVE 5% ON ALL ORDERS OVER \$500 OR SAVE 10% ON ALL ORDERS OVER \$1000

FAX 1-800-982-5934

www.HODES CO.com



PHONE 1-800-777-6500
243

FAUCETS AND EXTERNAL TRIM



TUB & SHOWER

RUBBER (949-240)
WASTE & OVERFLOW FACEPLATE
"HANG" GASKET

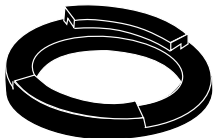

• For Price Pfister (others)
59-560 Waste & Overflow Gasket. **2.04**

SPONGE RUBBER
TUB WASTE WASHER



• 2-7/8" OD
 • 1-7/8" ID
 • 3/8" Thick
53-138 Tub Waste Washer. **2.20**

BEVELLED RUBBER
TUB DRAIN OVERFLOW
GASKET



53-132 Beveled Gasket. **2.28**

RUBBER
OVERFLOW GASKET



• Holds overflow to tub during assembly
 1 PER PACKAGE
53-133 Tub Overflow Gasket. **2.35**

RUBBER TUB DRAIN
GASKET

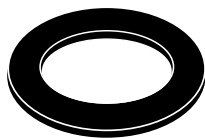

• 2-7/8" OD
 • 1-13/16" ID
 • 1/8" Thick
 SOLD 5 PER PACKAGE ONLY
59-509 Tub Drain Gasket. **1.18**

CHROMED BRASS
SINGLE HOLE
FACE PLATE
WITH SCREW

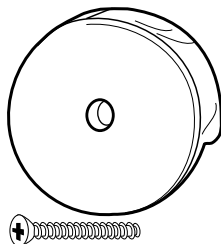

• With chromed brass screw
59-562 Brass Face Plate with Screw. **4.39**

CHROMED ZINC
TWO HOLE
FACE PLATE
WITH SCREWS

SCREWS ONLY

NEW
53-117 **.44¢**

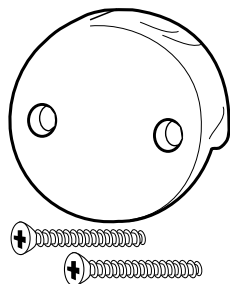

• With two chrome plated brass screws
53-119 Zinc Face Plate with Screws. **2.94**

CHROMED BRASS
TWO HOLE
FACE PLATE
WITH SCREWS

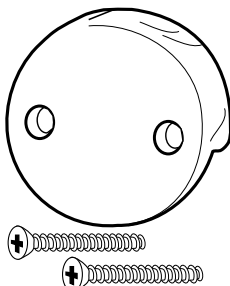

• With two chromed brass screws
59-549 Brass Face Plate. **4.66**

CHROMED ZINC
TWO HOLE
FACE PLATE
WITH COIL SPRING TRIP LEVER
WITH SCREWS

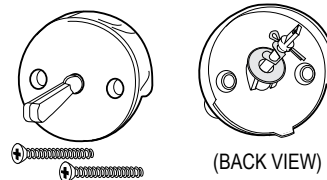

• With two chromed brass screws
 1 PER BOX
53-124 Zinc Face Plate with Clip. **3.53**

ZINC
TWO HOLE
FACE PLATE
WITH COIL SPRING TRIP
LEVER

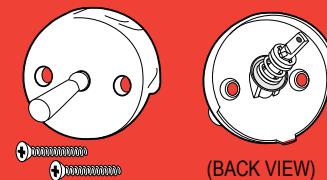

• With two chrome plated screws
 1 PER BOX
53-120 Chrome Plated. **4.10**
53-720 Polished Brass. **7.06**

SOLID BRASS TWO HOLE
FACE PLATE
WITH COIL SPRING TRIP LEVER
WITH SCREWS

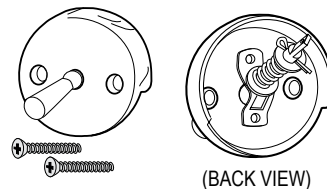

• With two chrome plated screws
 1 PER BOX
53-118 Chrome Plated. **6.63**
53-718 Polished Brass. **11.71**

TUB & SHOWER

USE YOUR CREDIT CARD AT TIME OF PURCHASE AND SAVE 2% ON ALL ORDERS, SAVE 5% ON ALL ORDERS OVER \$500 OR SAVE 10% ON ALL ORDERS OVER \$1000

FAX 1-800-982-5934 www.HODESCO.com PHONE 1-800-777-6500
 244 **HODESCO** PREFERRED PLUMBING PRODUCTS

WASTE & OVERFLOWS



FAUCETS AND EXTERNAL TRIM

TOE TOUCH WASTE & OVERFLOW

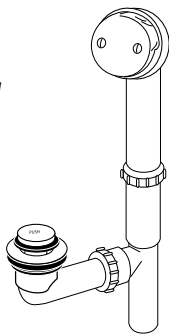

- PVC
- Chrome trim

1 PER BOX

57-997 Toe Touch **29.55**

WATTS REGULATOR PVC LIFT N' TURN

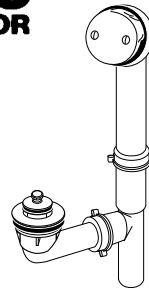

- Hi-tee
- No internal parts
- Chrome plated lift & turn plug
- Chrome plated o'flow assembly

1 PER BOX

56-401 Genuine Tubular W & O **21.50**

56-411 Genuine Sched. 40 W & O **NEW** **27.56**

WATCO PUSH-PULL WASTE & OVERFLOW (500PPVCCP)

- Theft resistant brass stopper
- Designed for heavy duty use in hotels, motels & rental property
- Extra deep brass strainer body for cast iron & plastic tubing
- Replacement drip proof Buna-N seal
- Retainer plate for overflow ell
- Push down with hand or foot to close, pull to open
- No stopper rotation required

1 PER BOX

56-403 PVC Waste & Overflow **32.14**

PVC SHOE OUTLET BATH WASTE

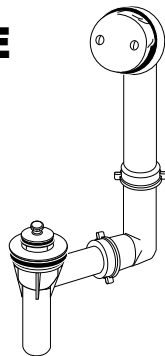

- Chrome plated brass exposed parts
- With telescopic elbow uni-lift tub drain

1 PER BOX

56-404 Shoe Outlet Waste **32.14**

WATCO TRIP LEVER WASTE & OVERFLOW (500TQPVCCP)

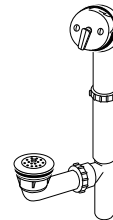

- 1-1/2" tube
- Fit-all design
- Theft-resistant brass stopper
- Extra-deep brass strainer body for cast iron & plastic tubs
- Replaceable drip-proof Buna-N seal
- Retainer plate for overflow ell
- No stopper rotation required

1 PER BOX

56-400 Genuine PVC Trip W & O **29.55**

BRASS PLUG & CHAIN LEG TUB WASTE & OVERFLOW

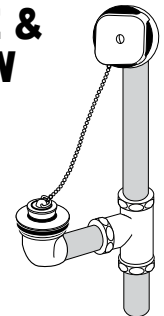

- 1-3/8" O.D. tube - 20 gauge
- Cast brass tee & strainer
- Chrome finish
- Exposed parts cp

1 PER BOX

53-103 1-3/8" OD W & O **81.79**

BRASS TRIP WASTE & OVERFLOW

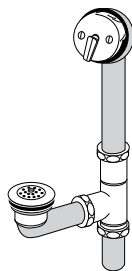

- 20 gauge brass tube
- Cast brass parts
- Chrome finish
- Plug-in tee
- 1-1/2" O.D.

1 PER BOX

53-100 Brass Trip Waste **61.34**

WATCO TRIP LEVER CHROME PLATED WASTE AND OVERFLOW FOR ROMAN / WHIRLPOOL TUBS

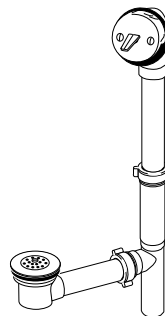

- PVC
- Fits most tubs to 24" high

56-938 Genuine Trip Waste and Overflow .. **47.76**

WATCO CHROME PLATED STURDY 1-1/2" SCHEDULE 40 PVC SOLVENT WELD ASSEMBLY PUSH/PULL BATH WASTE (601PP-PVC-CP) (601-PP-ABS)

- Extra deep brass strainer body for cast iron or plastic tubs
- Theft resistant brass stopper
- Designed for heavy duty use
- Replaceable drip proof Buna-N seal
- Chrome plated
- Push down with hand or foot to close
- For use with 1-1/2" SCH 40 ABS or PVC pipe

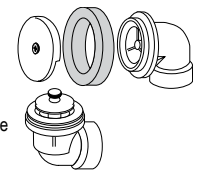

53-151 Chrome Plated/PVC **28.70**

53-150 Chrome Plated/ABS **28.70**

Oatey SCHEDULE 40 PUSH/PULL WASTE & OVERFLOW TEST KIT & ACCESSORIES

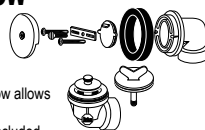

- Uniquely designed, single-hold overflow allows insertion of drain cleaning tools
- Easy to use, disposable test system included
- All PVD brass - scratch resistant, no discoloration
- 1 per box 20 per case

56-134 Chrome Plated/PVC **18.91**

57-134 Chrome Plated/ABS **29.55**

56-135 Polished Brass/PVC **37.81**

WATCO CHROME PLATED SCHEDULE 40 OVERFLOW ELBOW & DRAIN TEST PLUG (901-PP-PVC-CP) (901-PP-ABS-CP)

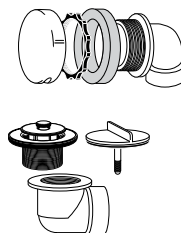

53-153 Genuine Chrome Plated/PVC **28.70**

53-152 Genuine Chrome Plated/ABS **28.70**

WATCO NUFIT™ PRESFLO™ TRIM KIT (48100-CP)

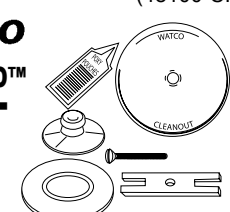

- Brass body, overflow plate, adapter bar, screw and suction cup
- Plastic stopper assembly
- Epoxy packet included

53-175 Genuine Trim Kit **34.19**

USE YOUR CREDIT CARD AT TIME OF PURCHASE AND SAVE 2% ON ALL ORDERS, SAVE 5% ON ALL ORDERS OVER \$500 OR SAVE 10% ON ALL ORDERS OVER \$1000

FAX 1-800-982-5934

www.HODESCO.com

PHONE 1-800-777-6500
245

WASTE & OVERFLOWS



GERBER
CHROME PLATED CAST BRASS WASTE & OVERFLOW WITH PUSH STOPPER

(41-848)

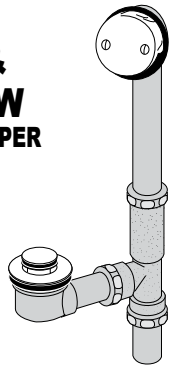

- Fits most tubs
- Adjusts 14" to 16" high
- Chrome plated
- 20 gauge

1 PER BOX

53-108 Genuine Waste & Overflow **58.92**

GERBER
CHROME PLATED WASTE & OVERFLOW WITH LIFT & TURN PLUG

(41-550)
(41-650)

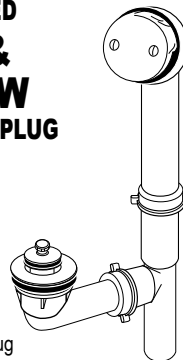

- Hi-tee
- No internal parts
- Chrome plated lift & turn plug
- Chrome plated overflow assembly

1 PER BOX

56-402 Genuine PVC Waste & Overflow ... **44.36**

57-402 Genuine ABS Waste & Overflow ... **44.36**

GERBER
CHROME PLATED PVC LIFT & TURN LESS TUBING

(41-552)

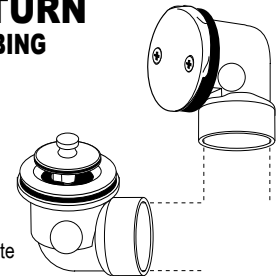

- Schedule 40
- Metal overflow plate
- Metal shoe plug

1 PER BOX

53-146 Genuine Gerber PVC Lift & Turn ... **28.92**

56-133 Generic PVC Lift & Turn **22.29**

GERBER
CHROME PLATED CAST BRASS WASTE & OVERFLOW WITH LIFT & TURN PLUG

(41-858)

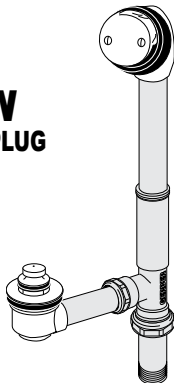

- Fits most tubs
- Adjust 14" to 16" high
- 1-1/2" diameter tube
- 20 gauge
- Includes retaining ring

1 PER BOX

53-109 Genuine Waste & Overflow **72.32**

GERBER
CHROMED PLATED PVC TRIP LEVER ROMAN TUB WASTE & OVERFLOW WITH GRID DRAIN

(41-513)



1 PER BOX

56-138 Genuine Gerber PVC W & O **61.00**

GERBER
CHROME PLATED PVC TRIP LEVER WASTE & OVERFLOW WITH GRID DRAIN & PRE-ADJUSTABLE LINKAGE

(41-510)

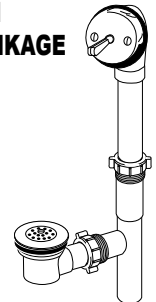

- Fits most tubs
- Adjusts 14" to 16" high
- 1-1/2" diameter tube

1 PER BOX

53-113 Genuine Waste & Overflow **35.54**

GERBER
CHROME PLATED CAST BRASS TRIP LEVER WASTE & OVERFLOW POP-UP STOPPER WITH PRE-ADJUSTABLE LINKAGE

(41-806)

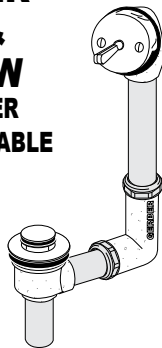

- Fits most tubs
- Adjusts 14" to 16" high
- 9-7/8" overflow brass tube
- 1-1/2" diameter tube
- 20 gauge

1 PER BOX

53-112 Genuine Waste & Overflow **97.37**

GERBER
CAST BRASS CHROME PLATED TRIP LEVER WASTE & OVERFLOW POP-UP STOPPER WITH PRE-ADJUSTABLE LINKAGE

(41-808)



- 20 gauge brass tube
- Extra long cast brass tee
- Chrome finish
- Cast brass plug & strainer

1 PER BOX

53-110 Genuine Pop-up Waste **97.37**

GERBER
CAST BRASS CHROME PLATED TRIP LEVER WASTE & OVERFLOW WITH GRID DRAIN & PRE-ADJUSTABLE LINKAGE

(41-818)



- Cast brass parts
- Chrome finish
- Extra long plug-in tee

1 PER BOX

53-111 Genuine 20 Gauge Trip Waste ... **69.88**

53-114 Genuine 17 Gauge Waste **NEW** ... **75.21**



USE YOUR CREDIT CARD AT TIME OF PURCHASE AND SAVE 2% ON ALL ORDERS, SAVE 5% ON ALL ORDERS OVER \$500 OR SAVE 10% ON ALL ORDERS OVER \$1000

SHOWER



FAUCETS AND EXTERNAL TRIM

For PRICE PFISTER

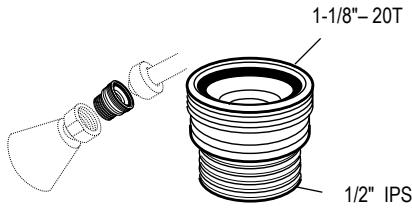

- Converts shower head arms with ball end
- For use with any standard shower head
- Chromed brass with o'ring

* Not Available From Price Pfister

12-197 *Generic Shower Head Adapter **1.76**

CHROMED BRASS 9" SHOWER HEAD EXTENSION

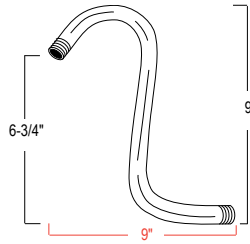

- Chromed brass pipe
- To raise the level of shower head
- 1/2" MIP x 1/2" MIP

13-165 9" Extension **15.56**

STAINLESS STEEL SHOWER ARM FLANGE

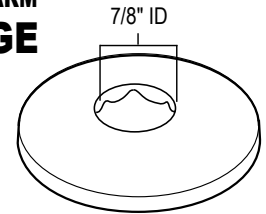

- For 1/2" diameter shower arms

SOLD 5 PER PACKAGE ONLY

13-214 SS Shallow Flange **.57¢**

13/16" I.D.

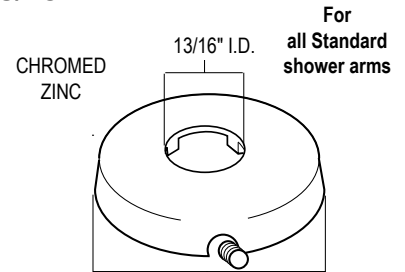

(Use with 1/2" shower arms)

13-212 CP Flange **5.61**

HEAVY GAUGE 6" CHROMED BRASS SHOWER ARM

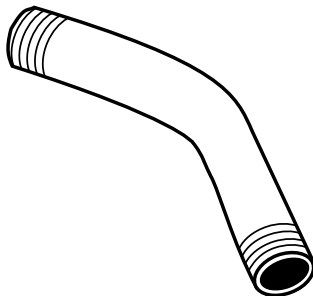

- 1/2" IPS

13-109 6" CP Brass Shower Arm **6.55**

CHROMED BRASS 11" SHOWER HEAD EXTENSION

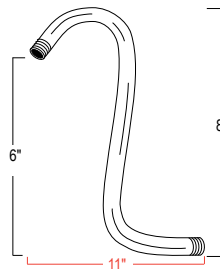

- Chromed brass pipe
- To raise the level of shower head
- 1/2" MIP x 1/2" MIP

13-166 11" Extension **11.15**

CHROMED BRASS SHOWER ARM FLANGE



NEW

13-211 Shower Arm Flange **17.80**

8" CHROMED BRASS SHOWER ARM

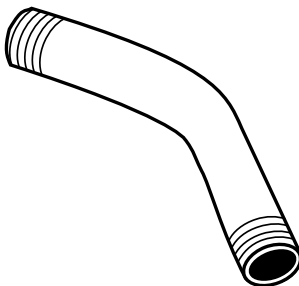

- 1/2" IPS

13-111 8" CP Brass Shower Arm **9.65**

CHROMED BRASS ADJUSTABLE SHOWER ARM

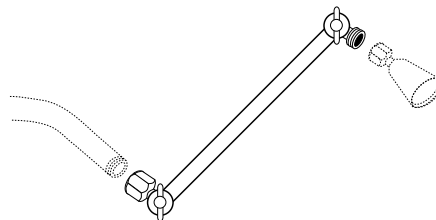

- 9" long center to center
- Chromed brass
- 1/2" FIP x 1/2" MIP

13-139 Adjustable Shower Arm **12.07**

CHROME PLATED POWER SHOWER SHOWER HEAD

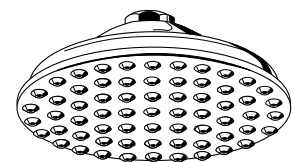

- 5-1/4" shower face
- 2.5 GPM at 80 PSI
- 1 per box coded display box

13-927 Shower Head **16.26**

USE YOUR CREDIT CARD AT TIME OF PURCHASE AND SAVE 2% ON ALL ORDERS, SAVE 5% ON ALL ORDERS OVER \$500 OR SAVE 10% ON ALL ORDERS OVER \$1000

FAX 1-800-982-5934

www.HODESCO.com

PHONE 1-800-777-6500
247

SHOWER

FAUCETS AND EXTERNAL TRIM



SHOWER HEADS

CHROMED SOLID BRASS WATER-SAVING POWER SHOWER HEAD WITH BRASS BALL JOINT

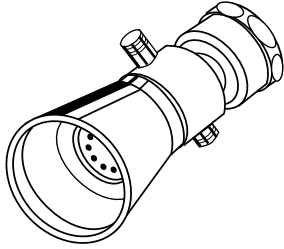

- All solid brass Uses standard 1/2" threads
- 1" diameter face 2.0 G.P.M. flow rate
- Cuts water use by 70% Chromed cast brass
- 1 per bar coded display box

13-147 Powerhead with Soap-Up Feature . . . **4.68**

CHROMED ZINC SHOWER HEAD WITH BRASS BALL JOINT

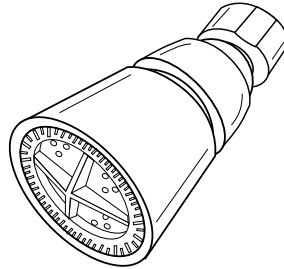

- 1-3/4" diameter face
- 2.5 GPM waterflow
- 1 per bar coded display box

13-118 CP Shower Head with Brass Ball Joint . **4.32**

CHROMED ABS SHOWER HEAD WITH BRASS BALL JOINT

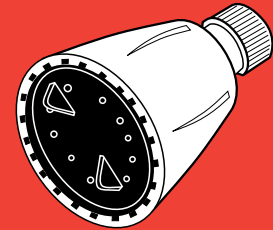

- 2" diameter face
- 2.5 GPM waterflow
- 1 per bar coded display box

13-113 Shower Head **4.68**

CHROMED PLATED BRASS SHOWER HEAD



- Chrome plated Brass
- 1-3/4" diameter face
- 1.5 GPM

NEW

13-144 Brass CP Shower Head **17.53**

DELTA (RP 6122)
FAUCET COMPANY
GENUINE PARTS

GENUINE DELTA SELF-CLEANING SHOWER HEAD

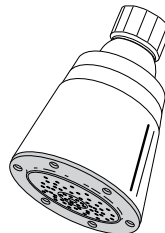

CHROME PLATED

13-162 Genuine Self-Cleaning Shower Head . . **19.93**

CHROMED SOLID BRASS FLOW CONTROL SHOWER HEAD WITH BRASS BALL JOINT

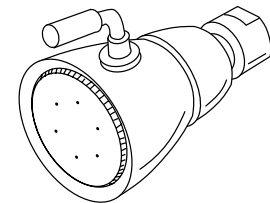

- Chrome plated or polished brass finish
- Adjustable spray
- 2.5 GPM 80 PSI
- 2-1/4" diameter face
- 1 per bar coded display box

13-150 Chrome Plated Shower Head **14.15**
13-151 Polished Brass Shower Head **23.61**

SHOWER HEADS

CHROMED PLATED BRASS SHOWER HEAD



- Chrome plated Brass
- 2" diameter face
- 1.5 GPM

NEW

13-145 Brass CP Shower Head **23.22**

SOLID BRASS SHOWER HEAD WITH BRASS BALL JOINT

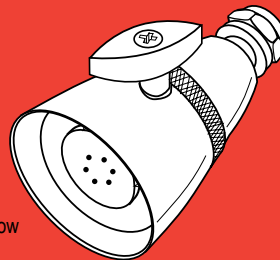

- 2.5 GPM waterflow
- All solid brass
- Adjustable blow head
- Adjusts from needle spray to heavy wash
- Removable "water saver" diaphragm
- 1 per bar coded display box

13-141 1-1/2" Dia. Chrome Shower Head **10.95**
13-142 2-1/4" Dia. Chrome Shower Head **11.60**

SPEAKMAN ANYSTREAM® SHOWER HEAD

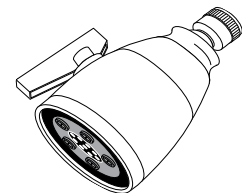

- Polished Chrome Plated Model 2
- Brass ball swivel joint & shank
- Spray adjusting T-handle 2-3/4" face
- 6 Lexan deposit-resisting plungers-48 spray channels
- Water conserving pressure compensating AUTOFLO device reduces flow to 2.5 gpm.

13-188 Speakman Anystream® Shower Head . **86.97**

USE YOUR CREDIT CARD AT TIME OF PURCHASE AND SAVE 2% ON ALL ORDERS, SAVE 5% ON ALL ORDERS OVER \$500 OR SAVE 10% ON ALL ORDERS OVER \$1000

FAX 1-800-982-5934 www.HODES CO.com PHONE 1-800-777-6500
248 **HODES CO.** PREFERRED PLUMBING PRODUCTS

SHOWER HEADS



FAUCETS AND EXTERNAL TRIM

CHROME PLATED 3 POSITION SPRAY MASSAGER SHOWER HEAD

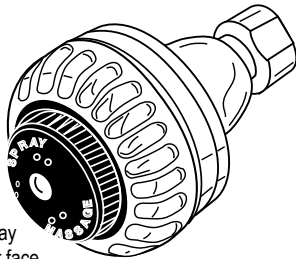

- 3 position spray
- 2-1/2" shower face
- Chrome plated
- 2.5 GPM at 60 PSI
- 1 per box coded display box

13-508 Massager Shower Head **8.12**

CHROME PLATED 3 POSITION SPRAY HAND-HELD SHOWER MASSAGER

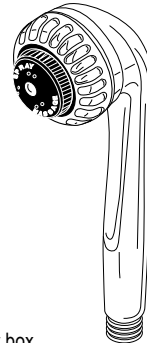

- 3 position spray
- 2-1/2" shower face
- Chrome plated
- 2.5 GPM at 60 PSI
- 1 per box coded display box

13-502 Hand- Held Massager **11.21**

BONE COLORED ABS HAND SPRAY HEAD

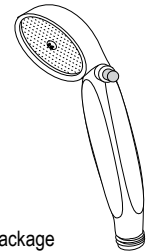

- 2" diameter face
- With "soap-up" shutoff
- 1 per bar coded display package

13-200 Hand Spray Head with Shut-Off **7.05**
13-201 Hand Spray Head less Shut-Off **6.81**

waterpik® POWER SPRAY WITH MASSAGER WHITE SHOWER HEAD

(SM-621)



- 2.5 gallons per minute
- 6 spray setting massager
- Installs on any standard shower arm, with no tools
- Switching spray and massage settings is as simple as gently turning your showerhead's outside control ring
- 5 year warranty

13-170 Genuine Showerhead **26.50**

waterpik® WHITE HAND HELD SHOWER

(SM-651)



- 2.5 gallon per minute
- 6 spray setting massager
- Installs on any standard shower arm, with no tools required
- Switching spray and massage settings is as simple as gently turning your showerhead's outside control ring
- Durable, easy-to-install mounting bracket gives you both hand-held and fixed-mount convenience
- High quality 5' hose makes your showerhead ideal for bathing children, seniors, pets and tub cleaning

13-171 Genuine Hand Held Shower **39.85**

HAND HELD SHOWER COMPLETE ASSEMBLY



- Push button Trickle
- Full spray setting
- 60" ultra flex hose
- Wall Mount
- 1 per bar coded display package

13-252 Chrome Hand Shower **66.90**
13-253 White Hand Shower **57.86**

WHITE HAND HELD SHOWER WITH STANDARD SPRAY



(462PB)
(462BX)
FIVE YEAR WARRANTY

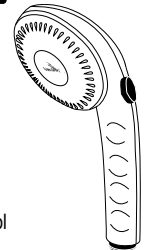

- Full spray setting
- Push button activated pause control
- 1 per bar coded display package

13-240 Hand Shower With Push Button **22.19**
13-239 Hand Shower Less Push Button **15.60**

Alsons® CHROME PLATED HAND HELD SHOWER COMPLETE ASSEMBLY

(410PBC)
FIVE YEAR WARRANTY



- 2.0 GPM maximum flow
- Package includes:
- Hand shower (full spray setting with push button pause control)
- Full length flexible hose (69" chrome and black)
- Adhesive wall mount
- Optional mounting screws and anchors
- Swivel connector
- 1 per bar coded display package

13-237 Complete Hand Held Shower Assembly . . . **63.38**

Alsons® CHROME PLATED HAND HELD SHOWER COMPLETE ASSEMBLY

(5435C)
FIVE YEAR WARRANTY

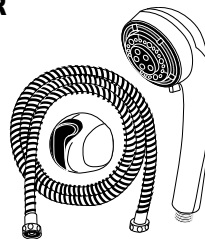

- 2.5 GPM maximum flow
- Package includes:
- Hand shower (5 spray settings)
- Full length flexible hose (69" chrome and black)
- Adhesive wall mount
- Optional mounting screws and anchors
- 1 per bar coded display package

13-232 Complete Hand Held Shower Assembly . . . **80.21**

Alsons® CHROME PLATED HAND HELD SHOWER COMPLETE ASSEMBLY



(410MAC)
FIVE YEAR WARRANTY

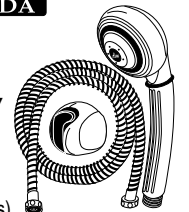

- 2.5 GPM maximum flow
- Package includes:
- Hand shower (5 spray settings)
- Full length flexible hose (69" chrome and black)
- Adhesive wall mount and Swivel connector
- 1 per bar coded display package

13-234 Complete Hand Held Shower Assembly . . . **91.37**

USE YOUR CREDIT CARD AT TIME OF PURCHASE AND SAVE 2% ON ALL ORDERS, SAVE 5% ON ALL ORDERS OVER \$500 OR SAVE 10% ON ALL ORDERS OVER \$1000

FAX **1-800-982-5934** www. **HODES CO.** .com PHONE **1-800-777-6500**
PROFFERED PLUMBING PRODUCTS 249

SHOWER HEADS

FAUCETS AND EXTERNAL TRIM



HAND-HELD SHOWER ACCESSORIES



FIVE YEAR WARRANTY (4923)

CHROME PLATED BRASS HAND HELD SHOWER WATER DIVERTER PUSH PULL CONTROL



- Diverts water flow from showerhead to hand shower
- 1 per bar coded display package

13-246 Genuine Water Diverter **37.61**
 13-300 Generic Water Diverter..... **15.15**

CHROME PLATED BRASS DIVERTER

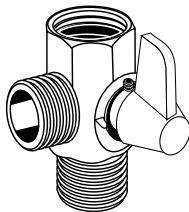

- To allow connection of flexible hose without interrupting flow of fixed shower head or leg tub spout
- 1 PER PACKAGE

13-205 Diverter For Fixed Shower **10.86**



FIVE YEAR WARRANTY (5001)

CHROME PLATED PLASTIC HAND HELD SHOWER WALL MOUNT

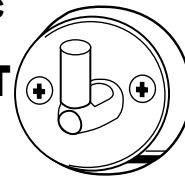

- Allows custom positioning of hand shower
- For stationary use and multiple height mounting (2 or more installed at different heights)
- 1 per bar coded display package

13-243 Genuine Wall Mount..... **13.11**

CHROMED BRASS ANTI-SCALD VOLUME REGULATOR

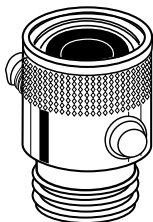

- Anti-scald drip feature
- Cast red brass
- Polished chrome
- Fits any head and arm
- Push button

1 PER BOX

13-115 1/2" MIP x 1/2" FIP..... **4.71**



FIVE YEAR WARRANTY (4900) (49130)

CHROME PLATED BRASS/PLASTIC HAND HELD SHOWER VACUUM BREAKER



- 1 per bar coded display package

13-249 Genuine Vacuum Breaker **26.47**
 13-449 Generic Vacuum Breaker **8.17**



FIVE YEAR WARRANTY (4301)

CHROME PLATED ZINC HAND HELD SHOWER SHOWER ARM MOUNT



- Attaches to your existing shower arm
- Pin mount for swivel connector applications
- 1 per bar coded display package

13-245 Genuine Shower Arm Mount **17.84**



LIFETIME WARRANTY (49070)

CHROME PLATED VINYL HAND HELD SHOWER ULTRAFLEX® HOSE



- 70" long
- Ultra flexible for easy draping and maneuvering
- Lightweight
- 1 per bar coded display package

13-241 Ultraflex® Hose **26.76**
 13-222 Hose Washer Only (Sold 10 per bag only) **.31¢**

STAINLESS STEEL FLEXIBLE HOSE

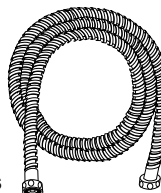

- 1/2" swivel FIP ends with gaskets
- 1 per bar coded display box

13-217 59" S.S. Hose **8.21**
 13-218 71" S.S. Hose **10.34**
 13-222 Hose Washer Only(10 per bag only) **.31¢**



FIVE YEAR WARRANTY (3401)

CHROME PLATED HAND HELD SHOWER ADJUSTABLE ARM MOUNT



NEW

• 1 per bar coded display package
 13-251 Genuine Shower Arm Mount **10.67**

CLEAR REINFORCED VINYL FLEXIBLE HOSE

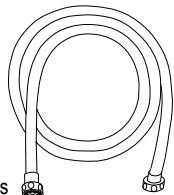

- 1/2" swivel FIP ends with gaskets
- 1 per bar coded display box

13-229 71" Clear Hose **23.38**
 13-230 79" Clear Hose **38.12**
 13-222 Hose Washer Only(10 per bag only) **.31¢**



FIVE YEAR WARRANTY (495D)

CHROME PLATED BRASS HAND HELD SHOWER HEAVY DUTY COMMERCIAL HOSE



- 69" long
- A favorite of plumbing professionals
- Durable and long lasting
- Double spiral bound
- 1 per bar coded display package

12-959 Genuine 60" Heavy Duty Hose..... **39.03**
 13-242 Genuine 69" Heavy Duty Hose..... **40.69**
 13-222 Hose Washer Only(Sold 10 per bag only) **.31¢**



FIVE YEAR WARRANTY (5002)

CHROME PLATED ZINC HAND HELD SHOWER SWIVEL CONNECTOR



- Adjusts the angle of your hand held shower and provides for side to side rotation
- Can be used on both wall mount and/or shower arm mount units
- 1 per bar coded display package

13-244 Genuine Swivel Connector..... **21.18**
 13-202 Generic Swivel Connector **5.89**

USE YOUR CREDIT CARD AT TIME OF PURCHASE AND SAVE 2% ON ALL ORDERS, SAVE 5% ON ALL ORDERS OVER \$500 OR SAVE 10% ON ALL ORDERS OVER \$1000

FAX 1-800-982-5934

www.HODES CO.com

PHONE 1-800-777-6500

HAND-HELD SHOWER

ESCUTCHEON NIPPLES



**FAUCETS AND
EXTERNAL TRIM**

CHROMED ZINC ADJUSTABLE SHOWER ROD SURFACE FLANGES

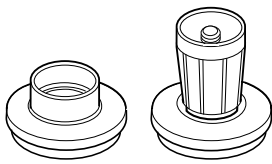

1 SET PER PACKAGE

13-126 CP Rod Holder (Die Cast) **2.11**

SHOWER ROD ONLY (LESS FLANGES)

5' LONG



- 5' long
- 1" O.D. polished aluminum
- 16 gauge high quality



SOLD 6 PER BOX ONLY

13-121 5' Shower Rod **7.64**

CURTAIN HOOKS

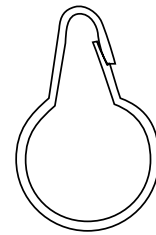

- Chrome plated

SOLD 25 PER PKG ONLY

13-127 CP Steel Curtain Hook **.23¢**

UNIVERSAL NIPPLE (PLASTIC)

(One nipple fits four of the most popular sizes)

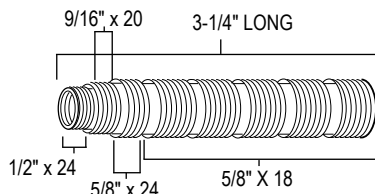

- 1/2 x 24: For Various Mfr.s
- 9/16 x 20: For American Standard, Central
- 5/8 x 18: For Crane, Repcal, Kohler
- 5/8 x 24: For Sterling, Royal, Sayco, Gerber

SOLD 2 PER PACKAGE

23-182 Plastic Nipple **1.42**

9/16" x 20 THREAD (BRASS)

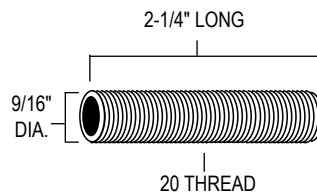

- For American Standard, Indiana, Eljer, Central Brass, Savoy, Harcraft

23-551 2-1/4" Brass Nipple **3.53**



www.HodesCo.com



**PAY BY MAJOR CREDIT CARD
WHEN YOU PLACE YOUR ORDER
AND SAVE UP TO AN
ADDITIONAL 10%
OFF OUR ALREADY
INDUSTRY-LOW PRICES!!**

5/8" x 24 THREAD (BRASS)

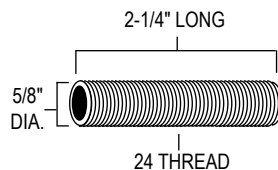

- For Gerber, Briggs, Sayco, Sterling, Union Brass

23-561 Brass Nipple **3.53**

5/8" x 27 THREAD (BRASS)

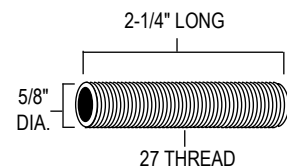

- For various Mfr's

23-563 Brass Nipple **3.53**

1/2" X 14 THREAD & 3/8" X 18 THREAD (BRASS)

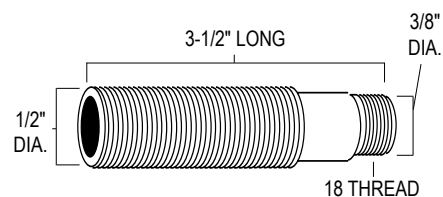

- For drinking fountains

23-567 4-1/2" Combo Brass Shank **4.67**

For PRICE PFISTER (972-110)

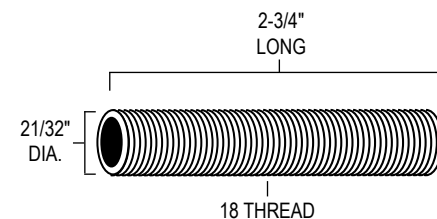

SOLD 5 PER PACKAGE ONLY

23-280 Generic Plastic Nipple **.88¢**

UNION BRASS (1711)

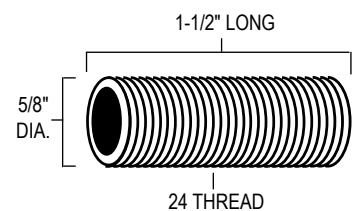

23-994 Genuine Zinc Nipple **2.33**

**USE YOUR CREDIT CARD AT TIME OF PURCHASE AND SAVE 2% ON ALL ORDERS,
SAVE 5% ON ALL ORDERS OVER \$500 OR SAVE 10% ON ALL ORDERS OVER \$1000**

FAX 1-800-982-5934 www.HODESCO.com PHONE 1-800-777-6500



FAUCETS AND EXTERNAL TRIM



ESCUTCHEON SLEEVES

For AMERICAN STANDARD (50667-02) (72826-02)

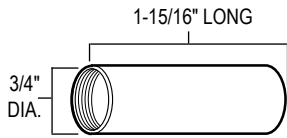

* Not Available From American Standard

COLONY

- 23-281 *Generic 1-15/16" Long CP Sleeve ... **5.90**
- 23-282 *Genuine CP Sleeve. **7.06**

For CENTRAL BRASS (PF-521-G)

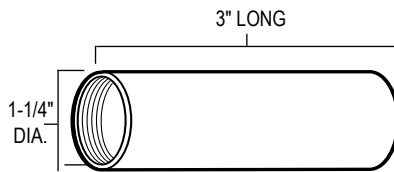

(Use with 23-199 escutcheon)

- 23-283 Generic CP Sleeve. **9.40**

For GERBER, BRIGGS, SAYCO, STERLING, UNION BRASS

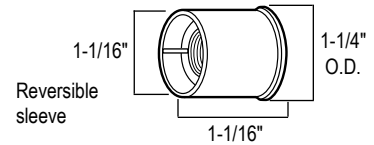

(Use with either 23-269 or 23-298 escutcheon)

• 5/8 - 24 thread

- 23-268 Generic CP Reversible Sleeve. **4.68**

For GERBER (90-021)

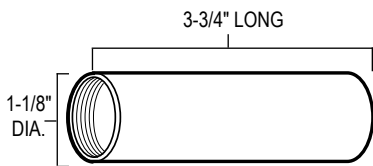

(Use with 23-299 escutcheon)

- 23-211 Generic CP Sleeve. **5.76**

For INDIANA BRASS

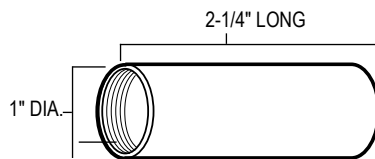

(Use with 23-290 escutcheon)

* Not Available From Indiana Brass

- 23-271 *Generic CP Sleeve. **5.83**

For KOHLER

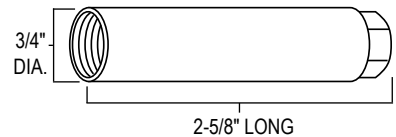

(Sleeve only for 28-634 stem)

TREND

- 23-934 Generic CP Sleeve. **4.46**

For MOEN (10089)

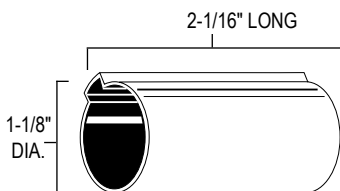

(Use with either 13-414 Escutcheon)

- 23-264 Generic CP Sleeve. **4.08**

For PRICE PFISTER (974-120)

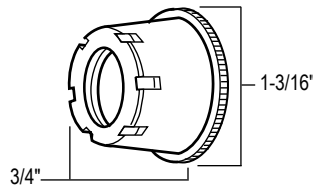

(Use with either 23-195 Escutcheon)

• 21/32 - 18 thread

SOLD 5 PER PACKAGE ONLY

- 23-497 Generic Adapter Sleeve. **1.17**

For PRICE PFISTER (971-100A)

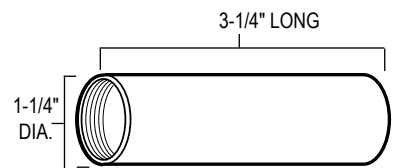

(Use with 23-199 Escutcheon)

* Not Available Separately From Price Pfister

- 23-285 *Generic CP Sleeve. **5.90**

For SAYCO (092)

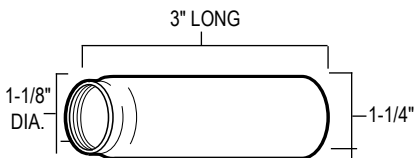

(Use with either 23-199 OR 23-212 Escutcheon)

* Not Available From Savoy

- 23-214 *Generic CP Sleeve. **4.69**

For STERLING (99B0493)

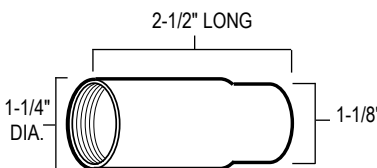

(Use with 23-199 Escutcheon)

- 23-996 Generic CP Sleeve. **4.68**

For UNION BRASS (1709)

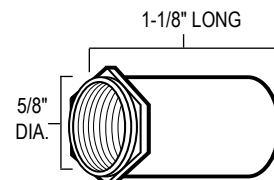

(Use with 23-990 Escutcheon)

- 23-998 Generic CP Sleeve. **3.41**

SLEEVES

USE YOUR CREDIT CARD AT TIME OF PURCHASE AND SAVE 2% ON ALL ORDERS, SAVE 5% ON ALL ORDERS OVER \$500 OR SAVE 10% ON ALL ORDERS OVER \$1000

TUB & SHOWER ESCUTCHEONS



FAUCETS AND EXTERNAL TRIM

MIRRORED ACRYLIC TUB AND SHOWER SHOWER ARM OR SPOUT REPAIR FLANGE

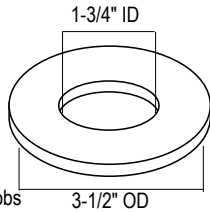

- Matches all bathrooms
- Eliminates costly retiling jobs
- Easily installed in minutes
- Conceals damaged or cracked tub/shower walls

13-640 Shower Flange **4.21**

SELF SEAL TUB SPOUT ESCUTCHEON/TRIM PLATE

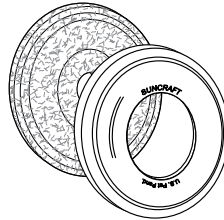

23-700 Escutcheon/Trim Plate **4.96**

CHROME PLATED TUB AND SHOWER SINGLE HANDLE REPAIR FLANGE

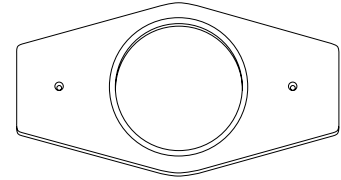

- Covers the holes used by Two-Handle Tub Faucet when replacing with a single control valve.

12-165 Cover Plate **20.65**

MIRRORED ACRYLIC TUB AND SHOWER SINGLE HANDLE REPAIR FLANGE

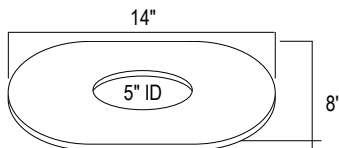

- Matches all bathrooms
- Eliminates costly retiling jobs
- Conceals damaged or cracked tub/shower walls
- Easily installed in minutes

13-641 Shower Flange **12.57**

MIRRORED ACRYLIC TUB AND SHOWER TWO HANDLE REPAIR FLANGE

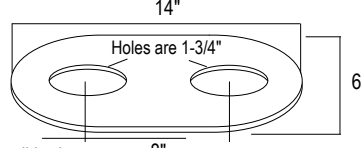

- Matches all bathrooms
- Eliminates costly retiling jobs
- Conceals damaged or cracked tub/shower walls
- Easily installed in minutes
- 1-3/4"

13-642 Shower Flange **12.74**

MIRRORED ACRYLIC TUB AND SHOWER THREE HANDLE REPAIR FLANGE

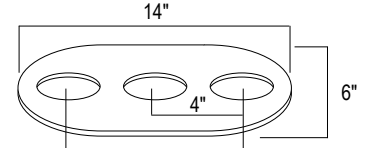

- Matches all bathrooms
- Eliminates costly retiling jobs
- Conceals damaged or cracked tub/shower walls
- Easily installed in minutes

13-643 Shower Flange **13.54**

For MIXET

(MLF)

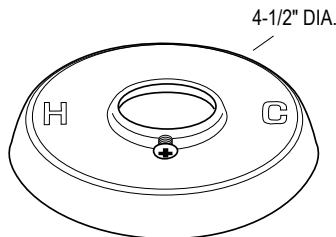

- Screws Included

13-411 CP Shower Flange **10.56**

For MIXET

(MLF-5-1/2)

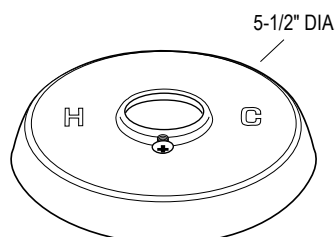

- Screws included

13-412 CP Shower Flange **11.52**

For MOEN

1-1/8\"/>

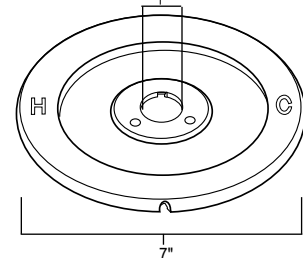

- Screws included

13-414 Generic CP Escutcheon **17.63**

CHATEAU

For MOEN

(ESCUTCHEONS - 171)
(SCREWS - 15528)

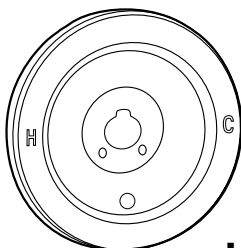

- Screws included

13-415 Generic CP 3 - Hole Shower Flange **20.45**

**LEGEND
PUSH BUTTON**

PRICE PFISTER CHROME PLATED SHOWER FLANGE

(960-370A)

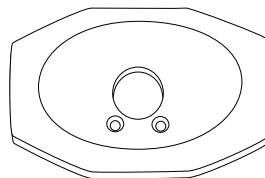

13-417 Genuine CP Shower Flange **26.72**

SPEAKMAN

(SP10-0206)

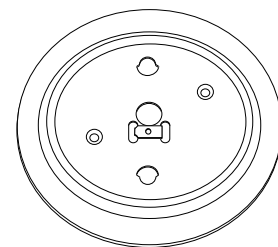

07-201 Genuine Speakman Cover Plate ... **35.44**

USE YOUR CREDIT CARD AT TIME OF PURCHASE AND SAVE 2% ON ALL ORDERS, SAVE 5% ON ALL ORDERS OVER \$500 OR SAVE 10% ON ALL ORDERS OVER \$1000

**FAX
1-800-982-5934**

www.HODES CO.com
PROFFERED PLUMBING PRODUCTS

**PHONE
1-800-777-6500
253**

ESCUTCHEONS

FAUCETS AND EXTERNAL TRIM



ESCUTCHEONS

"UNIVERSAL" ESCUTCHEON

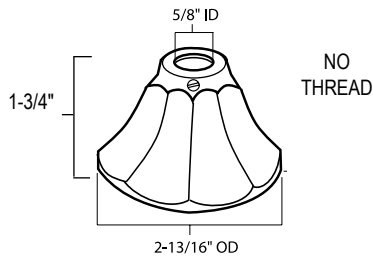

23-241 CP Escutcheon **4.68**

For AMERICAN STANDARD

(679-32)

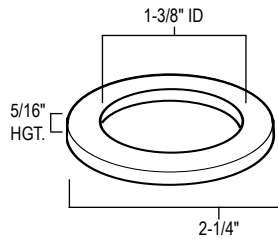

* Not Available From American Standard

23-681 *Generic CP Escutcheon **2.32**

For AMERICAN STANDARD

(1239-02)

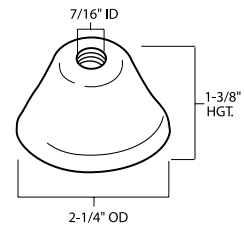

* Not Available From American Standard

23-287 *Generic CP Escutcheon **2.26**

For CENTRAL TUB & SHOWER

(521-B)

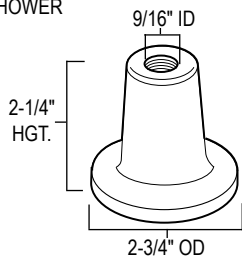

• 9/16" - 20 thread

23-890 Generic CP Escutcheon **2.35**

For CRANE/"UNIVERSAL" (Others)

(Use with 23-268 sleeve)

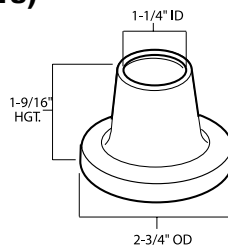

REVERSIBLE

23-298 Generic CP Escutcheon **3.50**



(RP1050) (Use with 23-303 Adjusting ring)

CP BRASS CAP AND ADJUSTING RING (TO REPAIR ALL SINGLE LEVER & KNOB FAUCETS)

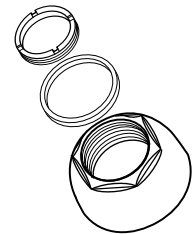

21-129 Genuine CP Brass Cap Assembly ... **7.08**

21-169 Genuine Cap Only **5.90**

GERBER ESCUTCHEON

(97-600)

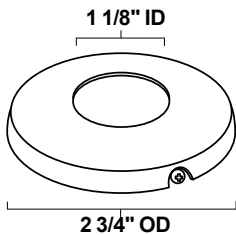

* With set screw

23-289 Genuine Escutcheon **6.63**

For HARCRAFT

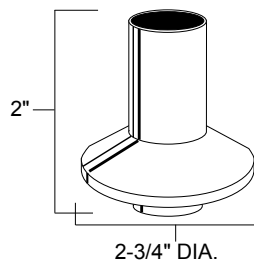

23-222 Generic CP Escutcheon **10.60**

KOHLER

(20851)

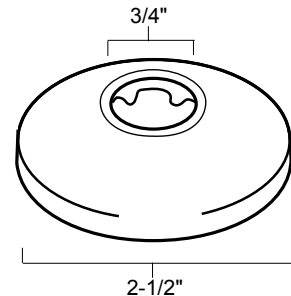

23-198 Genuine Escutcheon **9.79**

For PRICE PFISTER

(960-110A)

(Use with 23-497 sleeve)

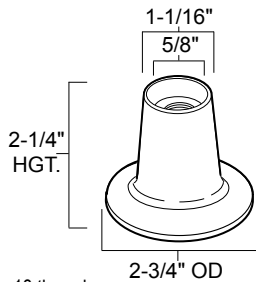

• 21/32 - 18 thread

23-195 Generic CP Flange **3.11**

For SAYCO

(056)

(Use with 23-214 sleeve)

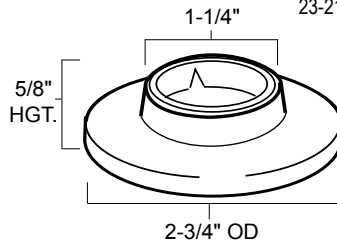

*Not Available from Sayco

23-212 *Generic CP Flange **2.32**

For UNION BRASS

(1130)

(Use with 23-998 sleeve)

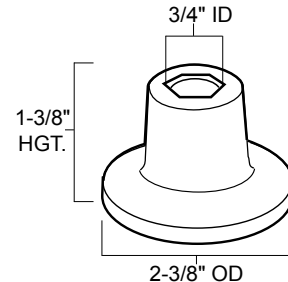

23-990 Generic CP Flange **2.35**

USE YOUR CREDIT CARD AT TIME OF PURCHASE AND SAVE 2% ON ALL ORDERS, SAVE 5% ON ALL ORDERS OVER \$500 OR SAVE 10% ON ALL ORDERS OVER \$1000

FAX 1-800-982-5934

www.HODESCO.com



PHONE 1-800-777-6500

ESCUTCHEONS

SET SCREW ESCUTCHEONS



FAUCETS AND EXTERNAL TRIM

13/16" I.D.

For American Standard, Nibco

CHROMED ZINC

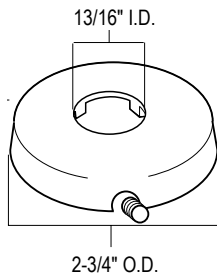

(Use with either 23-281 or 23-282 sleeve)

23-277 CP Flange..... **5.61**

7/8" I.D.

For all Standard shower arms

CHROMED ZINC

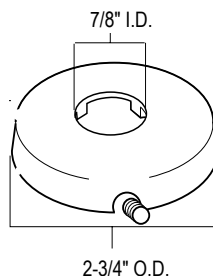

(Use with 1/2" shower arms)

13-212 CP Flange..... **5.61**

1" I.D.

For Eljer, Indiana, Milwaukee, Sterling

CHROMED ZINC

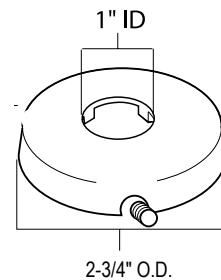

23-290 CP Flange..... **5.61**

1-1/8" I.D.

For Briggs, Gerber, Kohler

CHROMED ZINC

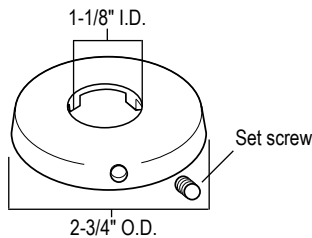

(Use with 23-211 sleeve)

23-299 CP Flange..... **5.61**

1-1/4" I.D.

For Central, Price Pfister, Sayco, Sterling, Streamway

CHROMED ZINC

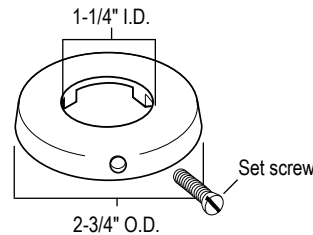

(Use with either 23-283, 23-285, 23-214, 23-996 sleeve)

23-199 CP Flange..... **5.61**

1-5/16" I.D.

For Speakman

CHROMED ZINC

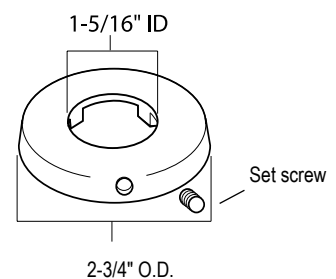

23-293 CP Flange..... **5.61**

COMPLETE HANDLE KITS

MEANS CUSTOMER CONVENIENCE . . .

Have you ever received a pair of handles only to spend the next couple of weeks tracking down the buttons and screws, so you will have complete handles?

NO LONGER! Our complete handle kits save you time and money. We provide everything needed to totally renew the look of a faucet.

Note: We have designed our handle kit item numbers for your receiving departments' convenience.

- Prefix "21-" for single temperature control handles
- Prefix "22-" for double temperature control acrylic handles
- Prefix "29-" for double temperature control chrome plated handles

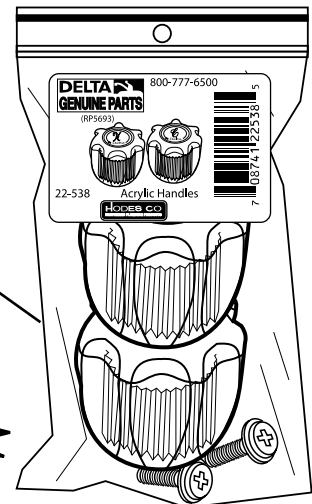

ESCUTCHEONS

USE YOUR CREDIT CARD AT TIME OF PURCHASE AND SAVE 2% ON ALL ORDERS, SAVE 5% ON ALL ORDERS OVER \$500 OR SAVE 10% ON ALL ORDERS OVER \$1000

FAX 1-800-982-5934 www.HODESCO.com PHONE 1-800-777-6500



FAUCETS AND EXTERNAL TRIM



FAUCET HANDLES

FIT-ALL
LAVATORY & KITCHEN

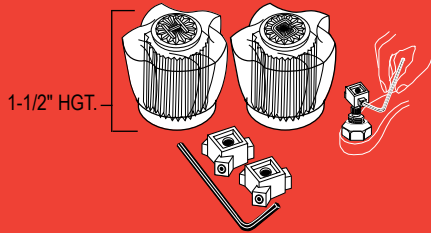

22-110 Acrylic Handles (Pair) **9.38**

FIT-ALL
TUB & SHOWER

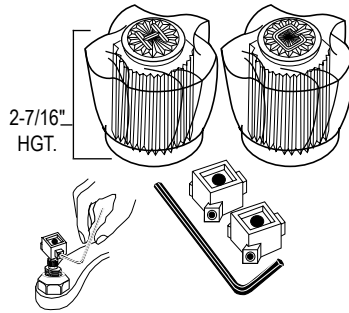

22-292 Acrylic Handles (Pair) **11.69**

FIT-ALL
HOSPITAL

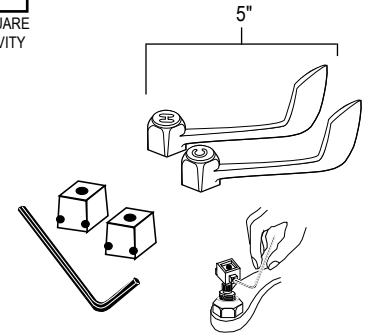

29-294 CP Handles (Pair) **10.37**

WISE-GRIP
LAVATORY, SINK, TUB & SHOWER



29-100 CP Handles (Pair) **4.08**

WISE-GRIP
LAVATORY, SINK, TUB & SHOWER

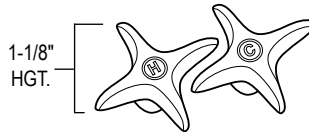

DOES NOT NEED RE-TIGHTENING
FITS ANY STEM FROM 1/4" TO 7/16"
DESIGNED FOR THE MECHANIC

29-101 CP Handles (Pair) **5.07**

FIT-ALL
LAVATORY & KITCHEN

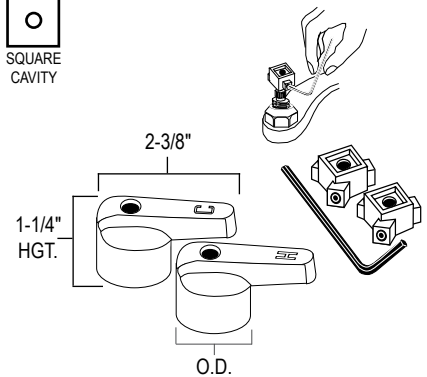

29-295 CP 1-3/8" O.D. Handles (Pair) **4.70**

FIT-ALL-EXACT
FAUCET HANDLE
ADAPTER KIT

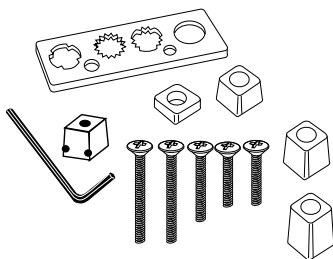

22-498 Fit-All-Exact Adapter Kit **4.31**

CHROME PLATED
FIT-ALL-EXACT
LEVER HANDLE
ASSEMBLY KIT

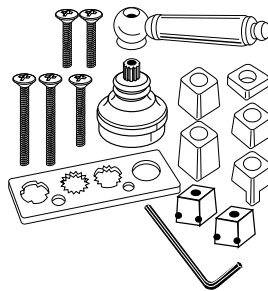

29-401 Fit-All -Exact Lever Handle Kit. **15.33**

CHROME PLATED
FIT-ALL-EXACT
HOSPITAL BLADE
HANDLE KIT

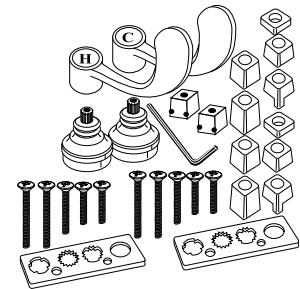

29-400 CP Fit-All Blade Handle Kit. **23.61**

HANDLES

USE YOUR CREDIT CARD AT TIME OF PURCHASE AND SAVE 2% ON ALL ORDERS, SAVE 5% ON ALL ORDERS OVER \$500 OR SAVE 10% ON ALL ORDERS OVER \$1000

FAX 1-800-982-5934 www.HODESCO.com PHONE 1-800-777-6500
256 **HODESCO** PROFFERED PLUMBING PRODUCTS

FAUCET HANDLES



FAUCETS AND EXTERNAL TRIM

ADVANTAGE™

KITCHEN

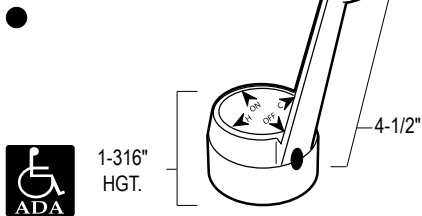

• Includes set screw

21-214 Genuine CP Handle (Each) **4.68**

ADVANTAGE™

LAVATORY

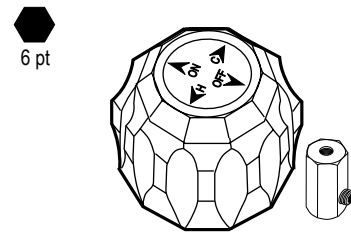

21-215 Genuine CP Handle (Each) **5.69**

ADVANTAGE™

LAVATORY, KITCHEN, TUB & SHOWER

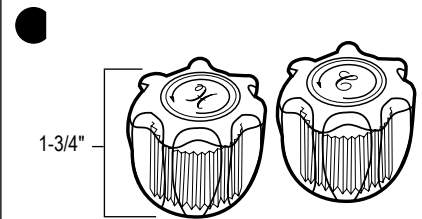

22-637 Genuine Acrylic Handles (Pair) **9.38**

ADVANTAGE™

LAVATORY, KITCHEN, TUB & SHOWER

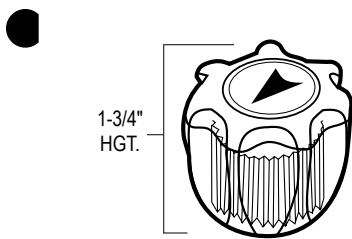

22-637D Generic Acrylic Diverter Handle (Each) .. **1.76**

For AMERICAN STANDARD (77033-02)

LAVATORY & TUB

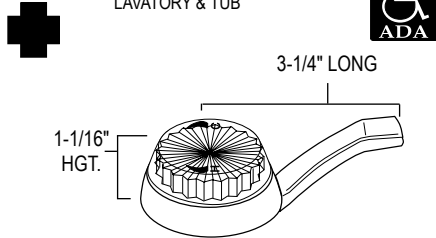

*Not Available From American Standard **AQUARIAN**

21-454 *Generic CP Handle (Each) **11.55**

For AMERICAN STANDARD (77031-02)

KITCHEN

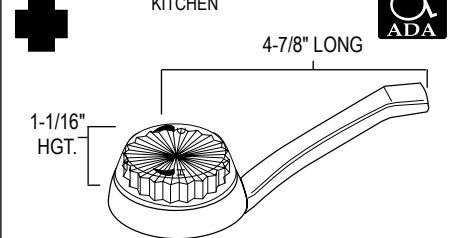

*Not Available From American Standard **AQUARIAN**

21-453 *Generic CP Handle (Each) **11.78**

For AMERICAN STANDARD (10889-02)

TUB & SHOWER

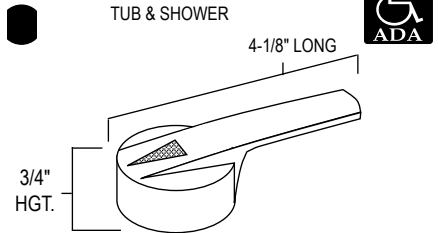

*Not Available From American Standard **ULTRAMIX**

21-950 *Generic CP Handle (Each) **5.90**

American Standard (66416-002)

TUB & SHOWER

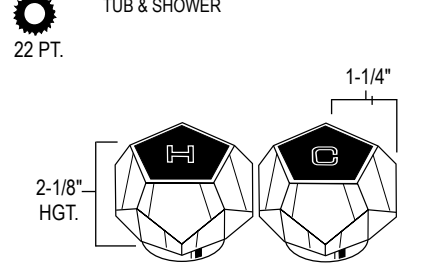

29-420 Genuine CP Handles (Pair) **35.21**

American Standard (66414-002)

TUB & SHOWER

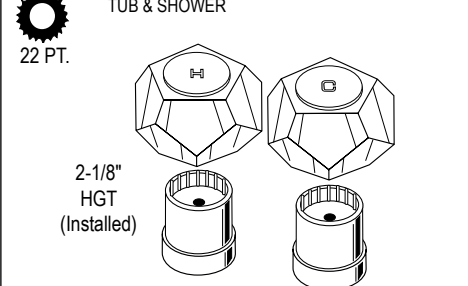

22-420 Genuine Acrylic Handles (Pair)..... **35.44**

For AMERICAN STANDARD (61269-021)

LAVATORY & KITCHEN

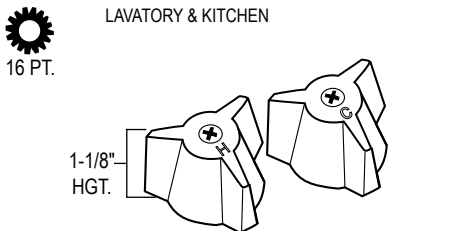

*Not Available From American Standard **COLONY**

29-428 *Generic CP Handles (Pair) **5.05**

For AMERICAN STANDARD (50671-021)

LAVATORY & KITCHEN

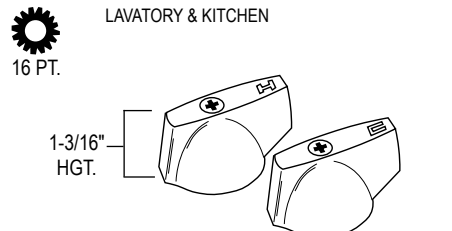

*Not Available From American Standard **COLONY**

29-464 *Generic CP Handles (Pair) **5.05**

For AMERICAN STANDARD (61154-02)

TUB & SHOWER

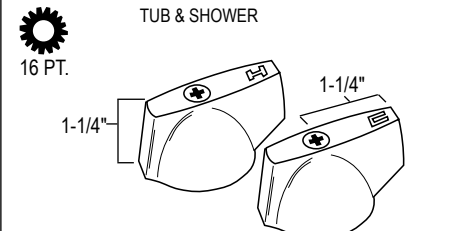

*Not Available From American Standard **COLONY**

29-463 *Generic CP Handles (Pair) **5.31**

USE YOUR CREDIT CARD AT TIME OF PURCHASE AND SAVE 2% ON ALL ORDERS, SAVE 5% ON ALL ORDERS OVER \$500 OR SAVE 10% ON ALL ORDERS OVER \$1000

FAX 1-800-982-5934 www.HODES CO.com PHONE 1-800-777-6500



FAUCETS AND EXTERNAL TRIM



FAUCET HANDLES

For AMERICAN STANDARD (72353-021)
(72353-023)



16 PT.

TUB & SHOWER

1-1/8" HGT.

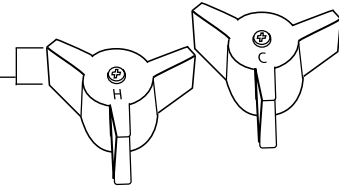

*Not Available From American Standard

COLONY

29-418 *Generic CP Handles (Pair) **15.31**

For AMERICAN STANDARD (64710-02H)
(64710-02C)



16 PT.

1-1/4"

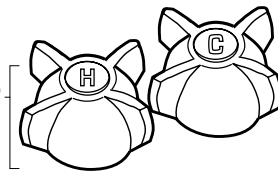

*Not Available From American Standard

COLONY SHELF BACK

29-431 Generic CP Handles (Pair) **7.67**

For AMERICAN STANDARD (13287-02)



16 PT.

TUB & SHOWER

2-1/2" HGT.

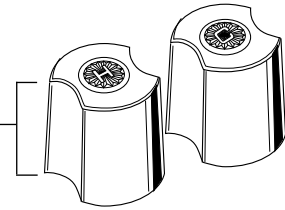

CADET

29-459 Generic CP Handles (Pair) **11.78**

For AMERICAN STANDARD (6458-021)
(6458-023)



22 PT.

LAVATORY & KITCHEN

1-9/16" HGT.

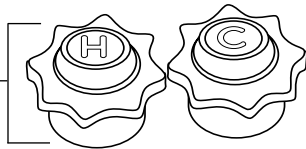

HERITAGE

29-415 Generic CP Handles (Pair) **10.37**

For AMERICAN STANDARD (6459-021)
(6459-023)



22 PT.

WIDESPREAD LAVATORY, TUB & SHOWER

1-5/8" HGT.

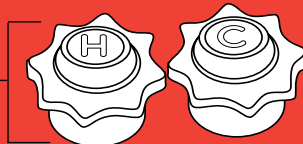

HERITAGE

29-416 Generic CP Handles (Pair) **11.60**
29-416D Generic CP Handles (Each) **8.55**

For BRIGGS (P300)



16 PT.

LAVATORY, TUB & SHOWER

2" HGT.



CASCADE

21-471 Generic Acrylic Handle (Each) **7.08**

For CENTRAL BRASS (523H)
(523C)



16 PT.

LAVATORY

1-1/8" HGT.

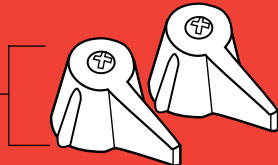

29-491 Generic CP Handles (Pair) **3.50**

For CENTRAL BRASS (G-508)



16 PT.

TUB & SHOWER

2-3/8" HGT.

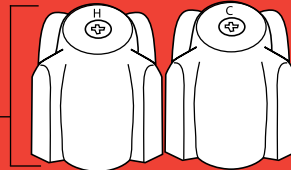

29-493 Generic CP Handles (Pair) **5.86**
29-493D Generic CP Diverter Handle (Each) **3.86**

CHICAGO FAUCETS (633)



8 PT.

5/8" HGT.

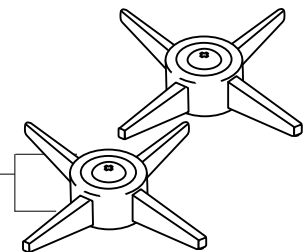

29-507 Genuine CP Handles (Pair) **30.92**

CHICAGO FAUCETS (369PR-JK)



8 PT.

SINK

2-3/8"

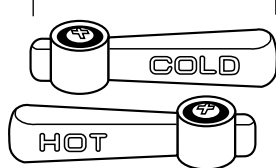

QUATURN

29-503 Genuine CP Handles (Pair) **26.65**

For CRANE (F16795)
(F16797)



12 PT.

LAVATORY & KITCHEN

1-1/16" HGT.

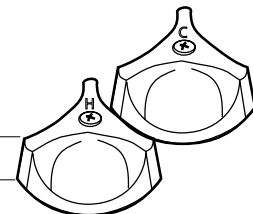

• 5/16" small broach

29-056 Generic CP Handles (Pair) **11.77**

For CRANE (F17634)
(F17636)



12 PT.

TUB & SHOWER

1-13/16" HGT.

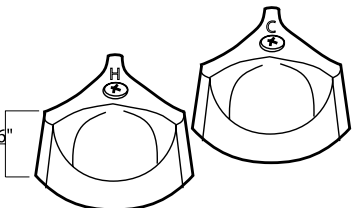

• 3/8" Large Broach

29-058 Generic CP Handles (Pair) **11.77**

USE YOUR CREDIT CARD AT TIME OF PURCHASE AND SAVE 2% ON ALL ORDERS, SAVE 5% ON ALL ORDERS OVER \$500 OR SAVE 10% ON ALL ORDERS OVER \$1000

FAX 1-800-982-5934 www.HODESCO.com PHONE 1-800-777-6500
258



FAUCET HANDLES



FAUCETS AND EXTERNAL TRIM

DELTA
FAUCET COMPANY
GENUINE PARTS
TUB & SHOWER

OLD# (RP2392)
NEW# (RP17655)

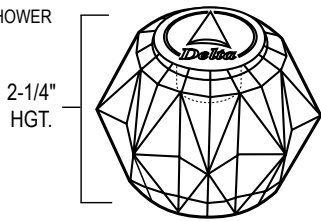

**FOR 1600 SERIES
SCALDGUARD**

21-539 Genuine Acrylic Handle (Each) **12.81**

DELTA
FAUCET COMPANY
GENUINE PARTS
TUB & SHOWER

OLD# (RP2391)
NEW# (RP17451)

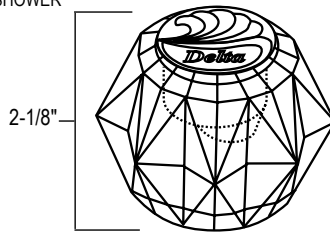

21-404 Genuine Acrylic Handle (Each) **12.81**

DELTA
FAUCET COMPANY
GENUINE PARTS
LAVATORY

OLD# (RP2389)
NEW# (RP17449)

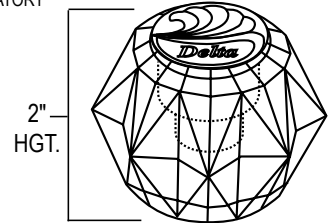

21-402 Genuine Acrylic Handle (Each) **12.67**

DELTA
FAUCET COMPANY
GENUINE PARTS

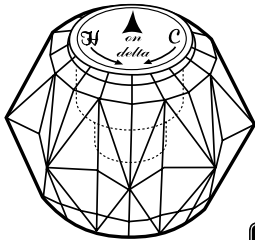

NEW

21-405 Genuine Acrylic Handle (Each) **22.39**

DELTA
FAUCET COMPANY
GENUINE PARTS
LAVATORY, KITCHEN, TUB & SHOWER

(RP20533)

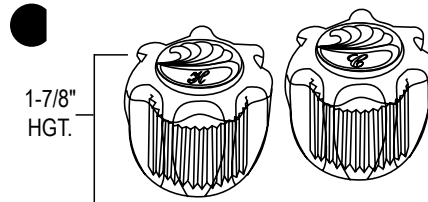

NEW STYLE

22-536 Genuine Acrylic Handles (Pair) **14.15**



**PAY BY MAJOR CREDIT CARD
WHEN YOU PLACE YOUR ORDER
AND SAVE UP TO AN
ADDITIONAL 10%
OFF OUR ALREADY
INDUSTRY-LOW PRICES!!**

DELTA
FAUCET COMPANY
GENUINE PARTS
LAVATORY, KITCHEN, TUB & SHOWER, WIDE SPREAD

(RP2390)

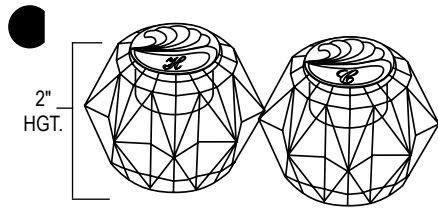

22-537 Genuine Acrylic Handles (Pair) **14.15**



www.HodesCo.com

DELTA
FAUCET COMPANY
GENUINE PARTS



NEW

07-298 Genuine Metal Lever Handle **38.73**

DELTA
FAUCET COMPANY
GENUINE PARTS

(RP90)

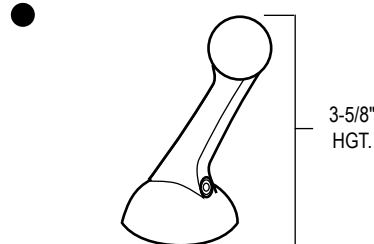

21-400 Genuine Chrome Handle (Each) . . . **13.33**

DELTA
FAUCET COMPANY
GENUINE PARTS

(RP2393)

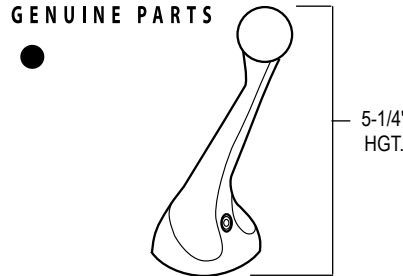

21-401 Genuine Chrome Handle (Each) . . . **15.26**

DELTA
FAUCET COMPANY
GENUINE PARTS

(RP17443)

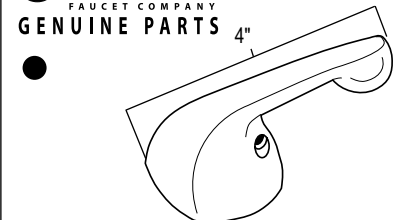

**FOR 600 SERIES
NEW STYLE**

21-403 Genuine Chrome Handle (Each) . . . **14.08**

**USE YOUR CREDIT CARD AT TIME OF PURCHASE AND SAVE 2% ON ALL ORDERS,
SAVE 5% ON ALL ORDERS OVER \$500 OR SAVE 10% ON ALL ORDERS OVER \$1000**

**FAX
1-800-982-5934**

www.HODES CO.com

**PHONE
1-800-777-6500
259**

HANDLES

FAUCETS AND EXTERNAL TRIM



FAUCET HANDLES

For ELJER

(490-6777H)
(490-6778C)

TUB & SHOWER



16 PT.

1-1/8" HGT.

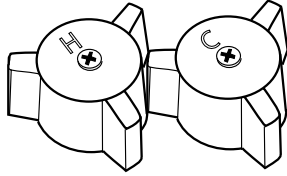

LUSTRA

29-559 Generic CP Handles (Pair) **8.20**

For ELJER

(490-6779)

TUB & SHOWER DIVERTER



16 PT.

1-1/8" HGT.

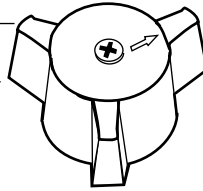

LUSTRA

29-559D Generic CP Handle (Each) **6.67**

For GERBER

(98-797H)
(98-797C)

LAVATORY & KITCHEN



16 PT.

1-1/2" HGT.

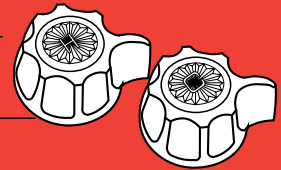

29-576 Generic CP Handles (Pair) **5.86**

29-565 Genuine CP Handles (Pair) **23.61**

For GERBER

(98-425)
(98-426)

LAVATORY & KITCHEN



16 PT.

1-3/4" HGT.

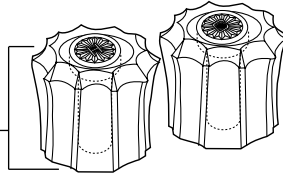

-LONG BROACH (ACRYLIC)

BUY 100 PAIR AT ONCE AND TAKE 50% OFF OUR ALREADY LOW NET PRICE!

22-577 Generic Acrylic Handles (Pair) **5.80**

For GERBER

(98-427)
(98-428)

TUB & SHOWER/WIDE LAVATORY



16 PT.

2-3/8" HGT.

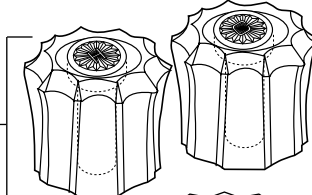

-LONG BROACH (ACRYLIC)

BUY 100 PAIR AT ONCE AND TAKE 50% OFF OUR ALREADY LOW NET PRICE!

22-578 Generic Acrylic Handles (Pair) **8.16**

For GERBER

(98-443H&C)
(98-443D)

TUB & SHOWER



16 PT.

2-3/8" HGT.

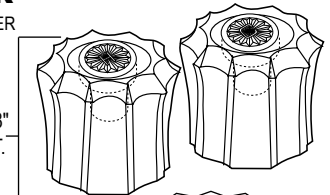

-SHORT BROACH (ACRYLIC)

BUY 100 PAIR AT ONCE AND TAKE 50% OFF OUR ALREADY LOW NET PRICE!

22-580 Generic Acrylic Handles (Pair) **8.16**

22-580D Generic Acrylic Diverter Handle (Each) **4.61**

For GERBER

(98-793H)
(98-793C)
(98-902PR)

TUB & SHOWER/WIDE LAV.



16 PT.

2-1/2" HGT.

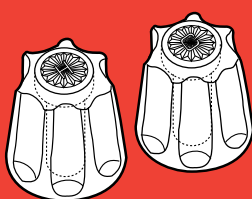

LONG BROACH

29-573 Generic CP Handles (Pair) **6.63**

29-573D Generic CP Diverter Handle (Each) **5.11**

For GERBER

(98-813H)
(98-813C)
(98-900PR)

TUB & SHOWER



16 PT.

2-1/2" HGT.

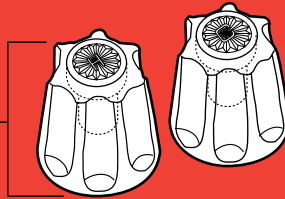

SHORT BROACH

29-579 Generic CP Handles (Pair) **5.80**

29-579D Generic CP Diverter Handle (Each) **3.79**

For GERBER

(91-590)
(91-591)

LAVATORY & KITCHEN



16 PT.

1-1/8" HGT.

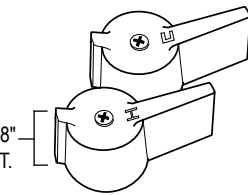

29-574 Generic CP Handles (Pair) **5.86**

For GERBER

(90-400)
(90-401)

TUB & SHOWER



16 PT.

1" HGT.

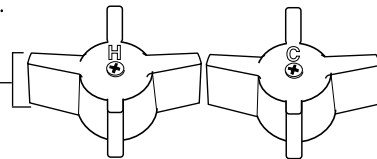

29-572 Generic CP Handles (Pair) **11.55**

For GERBER

(90-400D)

TUB & SHOWER DIVERTER



16 PT.

1-1/16" HGT.

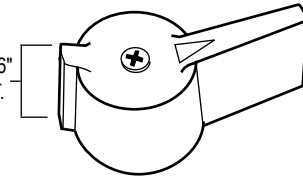

29-572D Generic CP Handle (Each) **3.86**

For HARCRAFT

LAVATORY & SINK



12 PT.

1-3/4" HGT.

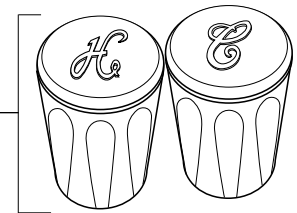

*Not Available From Harcraft

29-309 *Generic CP Handles (Pair) **5.86**

FAUCET HANDLES

USE YOUR CREDIT CARD AT TIME OF PURCHASE AND SAVE 2% ON ALL ORDERS, SAVE 5% ON ALL ORDERS OVER \$500 OR SAVE 10% ON ALL ORDERS OVER \$1000

FAX 1-800-982-5934 www.HODES CO.com PHONE 1-800-777-6500
260 **HODES CO.** PREFERRED PLUMBING PRODUCTS

FAUCET HANDLES



FAUCETS AND EXTERNAL TRIM

For INDIANA BRASS (SA-05H) (SA-05C)
TUB & SHOWER

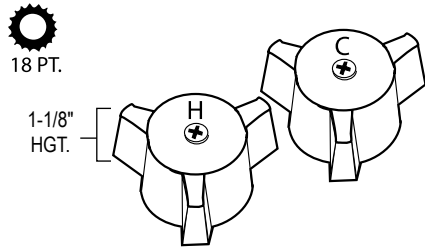

29-596 Generic CP Handles (Pair) **5.86**
29-596D Generic CP Diverter Handle (Each) . **3.86**

For KOHLER (42118)
LAVATORY, TUB & SHOWER

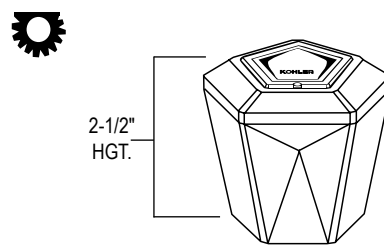

21-616 Generic Acrylic Handle (Each) **17.69**

For KOHLER (41239)
TUB & SHOWER

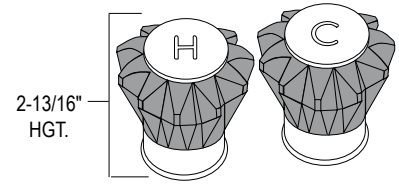

FLAIR
22-616 Generic Smoke Handles (Pair) **14.15**

For KOHLER (30009)
LAVATORY & KITCHEN

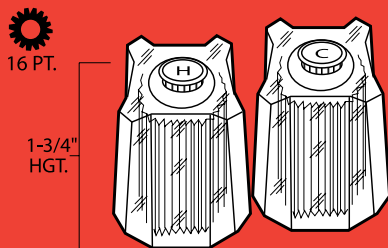

22-719 Generic Acrylic Handles (Pair) **5.86**

For KOHLER (70233)
LAVATORY, KITCHEN & TUB & SHOWER

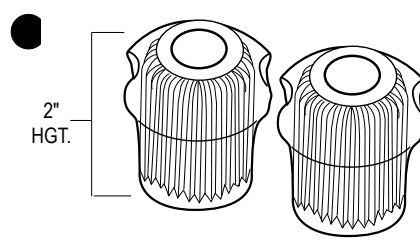

22-964 Generic Acrylic Handles **11.78**



**PAY BY MAJOR CREDIT CARD
WHEN YOU PLACE YOUR ORDER
AND SAVE UP TO AN
ADDITIONAL 10%
OFF OUR ALREADY
INDUSTRY-LOW PRICES!!**

For MIXET
TUB & SHOWER



• With set screw

21-920 Generic CP Handles **9.41**

For KOHLER (30005H) (30005C)
TUB & SHOWER

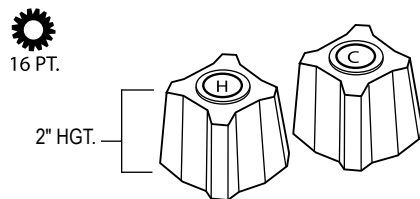

TREND
29-870 Generic CP Handles (Pair) **7.69**
29-870D Generic CP Diverter Handle (Each) . **5.04**

For KOHLER (41981)
TUB & SHOWER

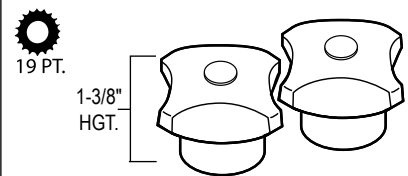

TRITON & CONSTELLATION
29-609 *Generic CP Handles (Pair) **76.53**

For MIXET (MTH-CLR)
TUB & SHOWER

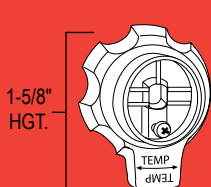

21-908 Generic Acrylic Handle (Each) **7.08**

For MIXET (MRH-CLR)
TUB & SHOWER

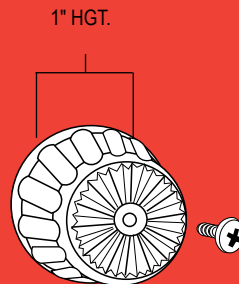

21-910 Generic Clear Acrylic Handle (Each) **5.90**

MOEN (96985)
POSI-TEMP HANDLE
TUB & SHOWER

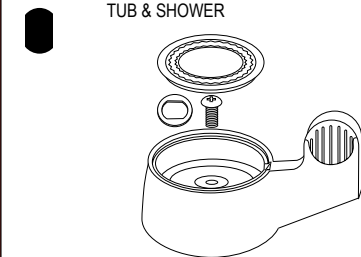

07-304 Genuine Moen Handle **20.06**

**USE YOUR CREDIT CARD AT TIME OF PURCHASE AND SAVE 2% ON ALL ORDERS,
SAVE 5% ON ALL ORDERS OVER \$500 OR SAVE 10% ON ALL ORDERS OVER \$1000**

FAX 1-800-982-5934 www.HODESCO.com PHONE 1-800-777-6500



HANDLES

FAUCETS AND EXTERNAL TRIM



FAUCET HANDLES

For MOEN
TUB & SHOWER

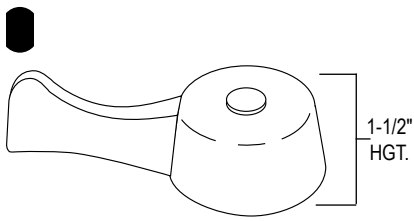

POSI-TEMP

21-322 Generic CP Handle (Each) **14.31**

For Moen
KITCHEN

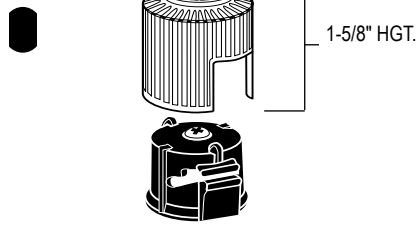

CHATEAU

*Not Available From Moen
21-669 *Generic Sub-Assembly **5.86**

For Moen
KITCHEN & BAR

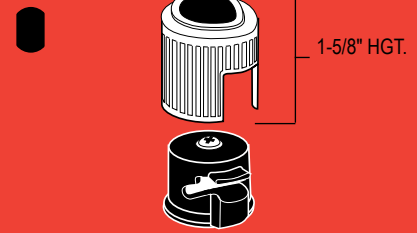

CHATEAU

(96790)
21-666 Generic Sub-Assembly (Each) **5.86**

For MOEN
KITCHEN

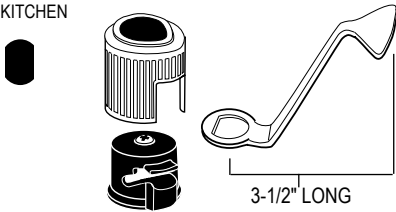

CHATEAU

(96790)
*Not Available From Moen
21-495 *Generic Complete Handle Assembly

For MOEN
TUB & SHOWER

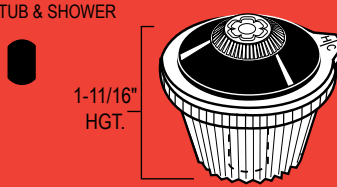

OLD STYLE BOUTIQUE LEGEND

(13094)
21-668 Generic Acrylic Handle (Each) **5.86**

For MOEN
LAVATORY

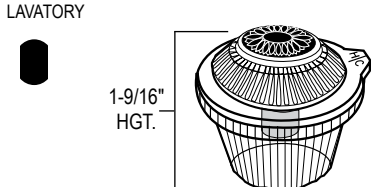

*Not Available From Moen

(13902)
21-650 *Generic Acrylic Handle (Each) **5.86**

For MOEN
LAVATORY

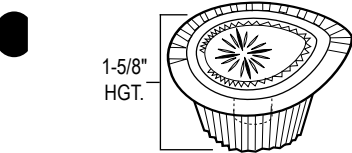

NEW STYLE CHATEAU

(96791)
21-656 Generic Acrylic Handle (Each) **5.86**

For MOEN
TUB & SHOWER

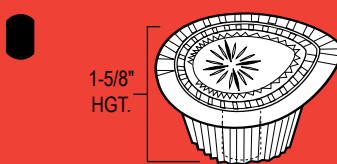

NEW STYLE CHATEAU

(96797)
21-653 Generic Acrylic Handle (Each) **5.86**

For MOEN
TUB & SHOWER

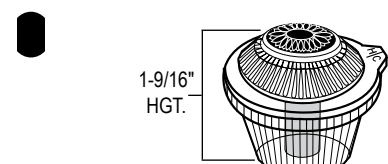

*Not Available From Moen

21-651 *Generic Acrylic Handle (Each) **5.86**

For MOEN
TUB & SHOWER

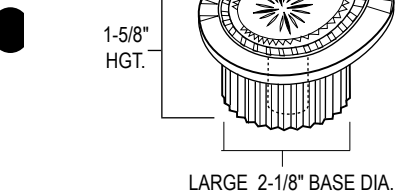

CHATEAU POSI-TEMP

(96884)
• Single control
• Long broach
21-960 Generic Acrylic Handle (Each) **7.05**

For MOEN
LAVATORY, KITCHEN, TUB & SHOWER

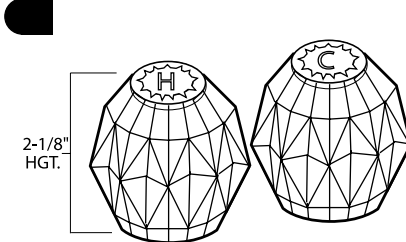

(13392H)
(13392C)
22-600 Generic Acrylic Handles (Pair) **8.83**

For NIBCO, PHOENIX
KITCHEN & LAVATORY OR TUB & SHOWER

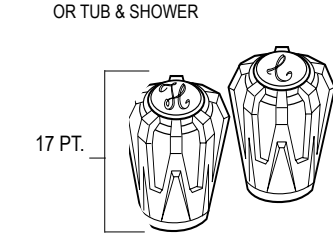

17 PT.
22-652 Generic Kit/Lav (Pair) (1-3/4" Hgt.) **5.86**

USE YOUR CREDIT CARD AT TIME OF PURCHASE AND SAVE 2% ON ALL ORDERS, SAVE 5% ON ALL ORDERS OVER \$500 OR SAVE 10% ON ALL ORDERS OVER \$1000

FAX 1-800-982-5934 www.HODESCO.com PHONE 1-800-777-6500
262

HANDLES

FAUCET HANDLES



FAUCETS AND EXTERNAL TRIM

For NIBCO

LAVATORY

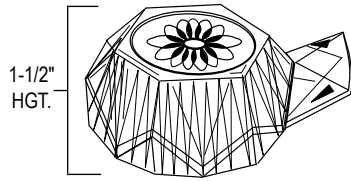

• Single control

21-963 Generic Acrylic Handle (Each) **10.26**

For NIBCO

LAVATORY, KITCHEN, BAR, TUB & SHOWER

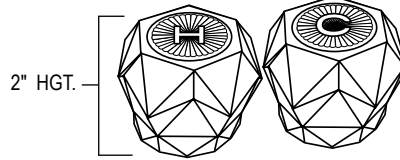

22-860 Generic Acrylic Handles (Pair) **8.23**

(86085H&C)

MCPOWERS PROCESS CONTROLS

(400-078)

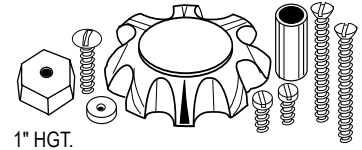

29-683 Genuine Acrylic Handle (Each) **37.13**

SERIES 400 MODEL 1-3

MCPOWERS PROCESS CONTROLS

(420-242)

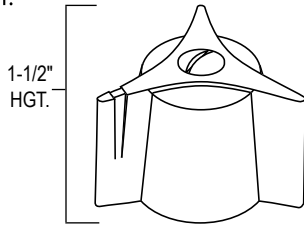

SERIES 427

29-680 Genuine Acrylic Handle (Each) **69.10**



www.HodesCo.com

For PRICE PFISTER

LAVATORY, TUB & SHOWER

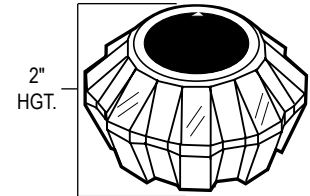

• Long broach

AVANTE 08 & 09 SERIES

21-961 Generic Acrylic Handle **11.55**

For PRICE PFISTER

TUB & SHOWER

(940-8010)

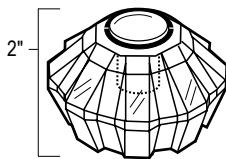

VERVE & WINDSOR 01 SERIES

• Short broach

21-965 Generic Acrylic Handle (Each) **11.55**

For PRICE PFISTER

TUB & SHOWER

(941-201)

(941-202)

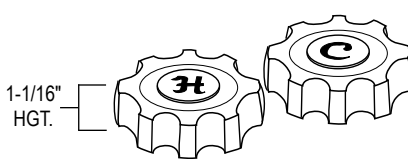

*Not Available From Price Pfister

CROWN IMPERIAL

29-690 *Generic CP Handles (Pair) **7.06**

For PRICE PFISTER

LAVATORY & KITCHEN

(941-121/131)

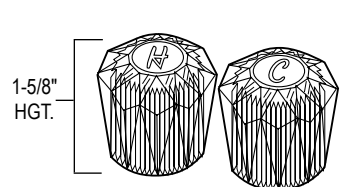

CONTESSA

22-783 Generic Acrylic Handles (Pair) **5.86**

USE YOUR CREDIT CARD AT TIME OF PURCHASE AND SAVE 2% ON ALL ORDERS, SAVE 5% ON ALL ORDERS OVER \$500 OR SAVE 10% ON ALL ORDERS OVER \$1000

FAX 1-800-982-5934

www.HODESCO.com

PHONE 1-800-777-6500

FAUCETS AND EXTERNAL TRIM



FAUCET HANDLES

For PRICE PFISTER (940-050A)
LAVATORY & KITCHEN (940-060A)

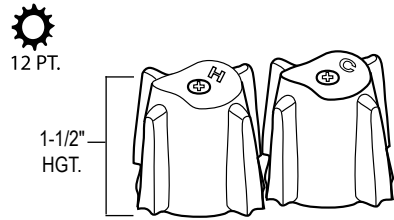

CONTEMPRA

29-850 Generic CP Handles (Pair) **5.86**

For PRICE PFISTER (940-020A)
TUB & SHOWER (940-030A)
(940-040A)

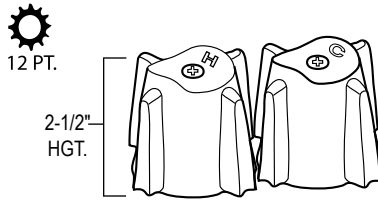

CONTEMPRA

29-852 Generic CP Handles (Pair) **7.05**
29-852D Generic CP Diverter Handle (Each) **5.04**

For PRICE PFISTER (941-061)
TUB & SHOWER (941-071)

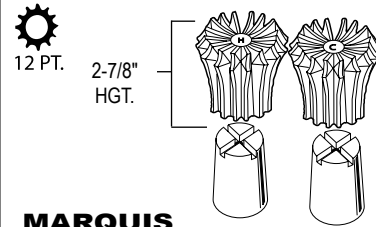

MARQUIS

22-787 Generic Acrylic Handles (Pair) **7.05**
22-787D Generic Diverter Handle (Each) ... **3.86**

For PRICE PFISTER (941-322)
LAVATORY & KITCHEN (941-332)

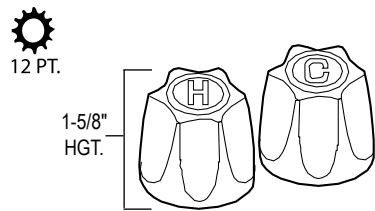

VERVE

29-700 Generic CP Handles (Pair) **4.68**

For PRICE PFISTER (941-321)
TUB & SHOWER (941-331)

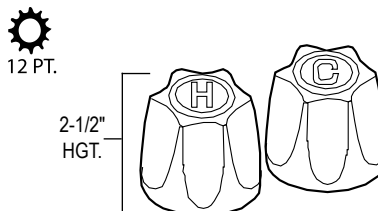

VERVE

29-702 Generic CP Handles (Pair) **5.86**

For PRICE PFISTER (941-341A)
TUB & SHOWER DIVERTER

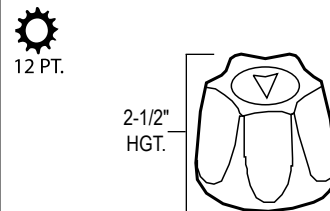

VERVE

29-702D Generic CP Handle (Each) **4.09**

For PRICE PFISTER (940-740)
TUB & SHOWER

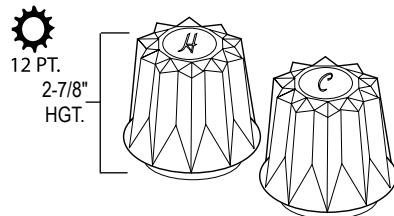

WINDSOR

22-693 Generic Acrylic Handles (Pair) **5.86**
22-693D Generic Acrylic Diverter Handle (Each) .. **3.26**

For PRICE PFISTER
LAVATORY & KITCHEN

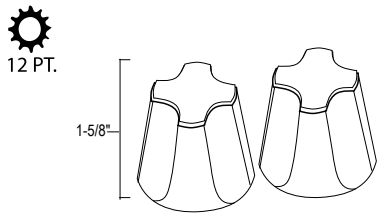

NEW STYLE VERVE

29-764 Generic CP Handles (Pair) **10.61**

For PRICE PFISTER
TUB & SHOWER

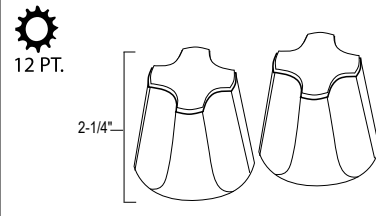

NEW STYLE VERVE

29-763 Generic CP Handles (Pair) **11.50**

For PRICE PFISTER (940-210)
LAVATORY (940-220)

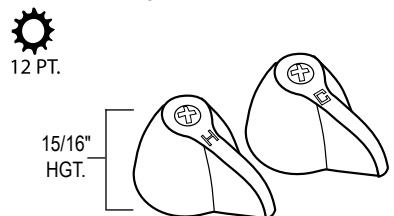

29-697 Generic CP Handles (Pair) **3.50**

For PRICE PFISTER (940-250)
KITCHEN (940-260)

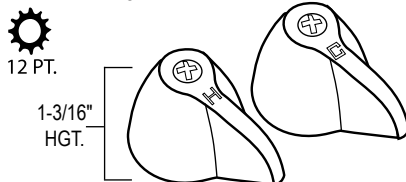

CROWN JEWEL

*Not Available From Price Pfister

29-698 *Generic CP Handles (Pair) **4.68**

For SAVOY
LAVATORY & KITCHEN

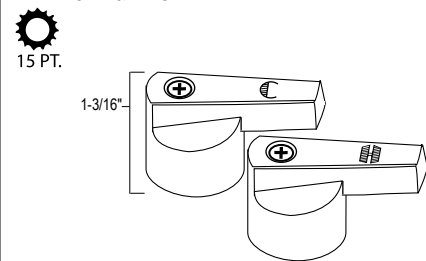

29-046 Generic CP Handles (Pair) **10.61**

USE YOUR CREDIT CARD AT TIME OF PURCHASE AND SAVE 2% ON ALL ORDERS, SAVE 5% ON ALL ORDERS OVER \$500 OR SAVE 10% ON ALL ORDERS OVER \$1000

FAUCET HANDLES



FAUCETS AND EXTERNAL TRIM

For SAYCO (P24F84/23)
TUB & SHOWER

BUY 100 PAIR AT ONCE AND TAKE 50% OFF OUR ALREADY LOW NET PRICE!



16 PT.

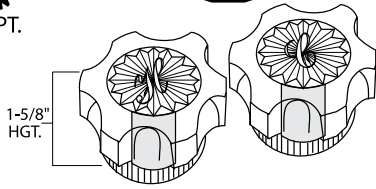

1-5/8" HGT.

*Not Available From Sayco

LONG BROACH

22-758 *Generic Acrylic Handles (Pair) **4.68**

For SAYCO
LAVATORY & KITCHEN



16 PT.

1-1/16" HGT.

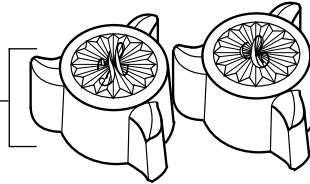

*Not Available From Sayco

CITATION

29-745 *Generic CP Handles (Pair) **5.86**

For SAYCO (72F48)
TUB & SHOWER (72F73)
(72F48/73D)



16 PT.

1-1/2"

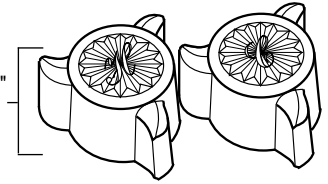

*Not Available From Sayco

CITATION

29-746 *Generic CP Handles (Pair) **7.91**

29-746D *Generic CP Diverter Handle (Each) **3.43**

For SAYCO (2521F57/23H&C)
LAVATORY & KITCHEN



16 PT.

1-5/8" HGT.

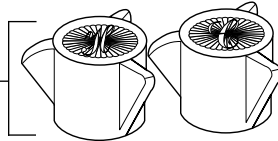

*Not Available From Sayco

29-747 *Generic CP Handles (Pair) **5.86**

For SAYCO (22-F79/23H&C)
TUB & SHOWER



16 PT.

2-1/4" HGT.

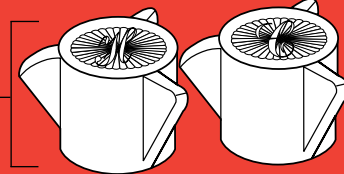

*Not Available From Sayco

29-748 *Generic CP Handles (Pair) **7.05**

29-748D *Generic CP Diverter Handle (Each) **4.61**

For STERLING (A0980)
TUB & SHOWER



1-1/4"

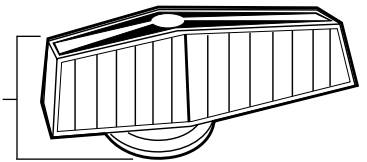

21-761 Generic Clear Handle (Each) **3.50**

For STERLING (00A8253)
LAVATORY & KITCHEN (00A8254)



16 PT.

1-1/4" HGT.

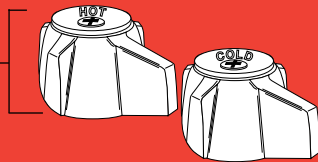

29-787 Generic CP Handles (Pair) **5.86**

For STERLING (A8250)
TUB & SHOWER (A8251)



16 PT.

1-1/4" HGT.

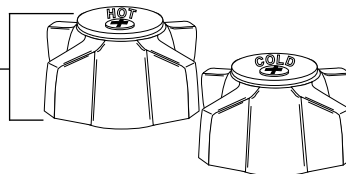

29-788 Generic CP Handles (Pair) **9.28**

For STERLING
TUB & SHOWER



16 PT.

1-1/4" HGT.

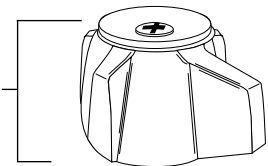

29-788D Generic CP Diverter Handle **5.83**

For STERLING (A8369H)
LAVATORY, KITCHEN, TUB & SHOWER (A8369C)



16 PT.

2-1/8" HGT.

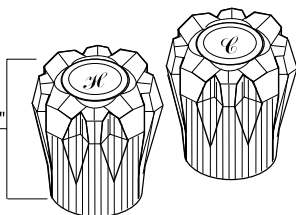

22-790 Generic Acrylic Handles (Pair) **9.36**

For STERLING OLD # NEW #
LAVATORY & KITCHEN (A1382H) (A2990H)
(A1382C) (A2990C)



2-1/8" HGT.

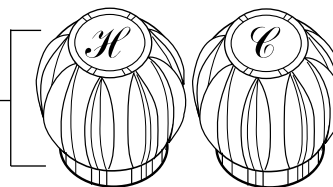

22-791 *Generic Acrylic Handles (Pair) **7.66**

For STERLING (A1926)
LAVATORY & KITCHEN



16 PT.

1-1/2" HGT.

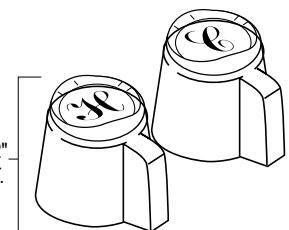

STARFLO

29-786 Generic CP Handles (Pair) **7.96**

USE YOUR CREDIT CARD AT TIME OF PURCHASE AND SAVE 2% ON ALL ORDERS, SAVE 5% ON ALL ORDERS OVER \$500 OR SAVE 10% ON ALL ORDERS OVER \$1000

FAX 1-800-982-5934

www.HODESCO.com



PHONE 1-800-777-6500

FAUCETS AND EXTERNAL TRIM



FAUCET HANDLES

For STREAMWAY
LAVATORY & KITCHEN

(1500-3H)
(1500-3C)

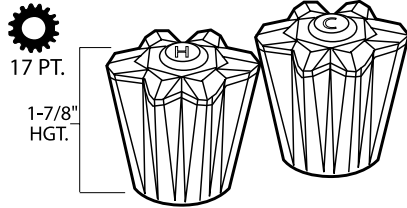

17 PT.
1-7/8" HGT.

*Not Available From Streamway

22-802 *Generic Lav. & Kit. Acrylic Handles (Pair) **8.25**



PAY BY MAJOR CREDIT CARD WHEN YOU PLACE YOUR ORDER AND SAVE UP TO AN ADDITIONAL 10% OFF OUR ALREADY INDUSTRY-LOW PRICES!!



12 PT.
1-1/4" HGT.

• Zinc Die Cast
• No Longer Available From Symmons

TEMPROL

81-805 Genuine CP Thermoplastic Handle (Each) . **19.93**
21-305 Generic CP Handle Zinc Die Cast (Each) . . . **8.79**



(T-30)
(S-30)



29-808 Genuine CP Handle (Each) **10.86**

For SYMMONS
SHOWER

(RC-14)

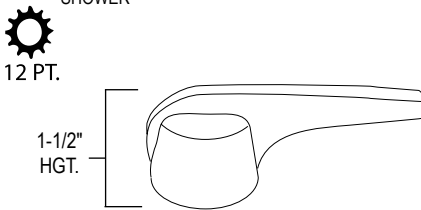

12 PT.
1-1/2" HGT.

SAFETY MIX

21-311 Generic CP Handle (Each) **11.78**



PAY BY MAJOR CREDIT CARD WHEN YOU PLACE YOUR ORDER AND SAVE UP TO AN ADDITIONAL 10% OFF OUR ALREADY INDUSTRY-LOW PRICES!!



(2881-40)

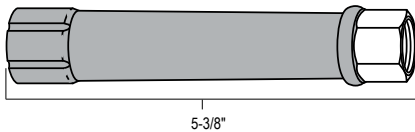

5-3/8"

• Handle only for models B-1400 & B-1403

REEL KLEEN

07-230 Genuine Handle **28.55**

For T & S
SINK

(23F)

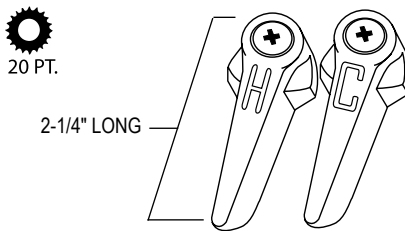

20 PT.
2-1/4" LONG

29-817 Generic CP Handles (Pair) **9.41**

10-131 Genuine Lever Handle Kit **18.68**

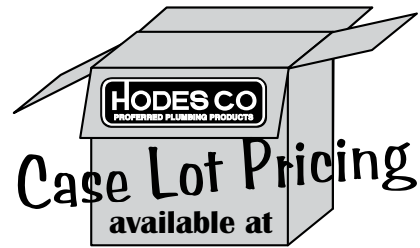

www.HodesCo.com

For UNION BRASS
LAVATORY

(1349H)
(1349C)

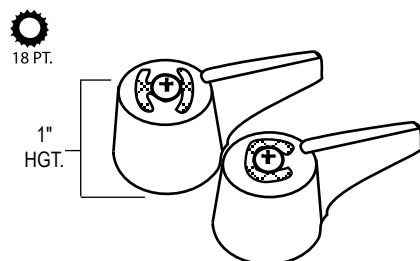

18 PT.
1" HGT.

29-524 Generic CP Handles (Pair) **5.86**

For UNION BRASS
KITCHEN

(1348H)
(1348C)

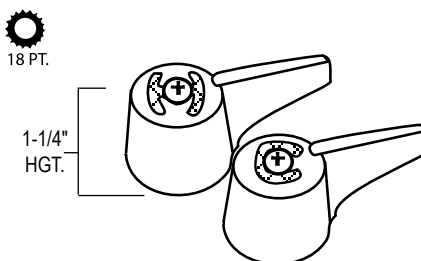

18 PT.
1-1/4" HGT.

29-520 Generic CP Handles (Pair) **11.12**

For UNION BRASS
TUB & SHOWER

(1346H)
(1346C)

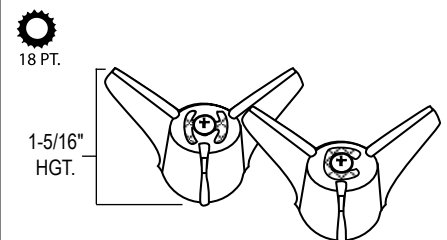

18 PT.
1-5/16" HGT.

29-829 Generic CP Handles (Pair) **11.58**

USE YOUR CREDIT CARD AT TIME OF PURCHASE AND SAVE 2% ON ALL ORDERS, SAVE 5% ON ALL ORDERS OVER \$500 OR SAVE 10% ON ALL ORDERS OVER \$1000

FAX 1-800-982-5934 www.HODESCO.com PHONE 1-800-777-6500
266



FAUCET HANDLES



FAUCETS AND EXTERNAL TRIM

For UNION BRASS
TUB & SHOWER

(1378H)
(1378C)



18 PT.

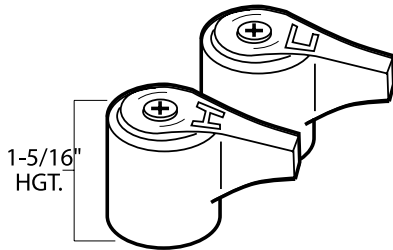

1-5/16"
HGT.

29-525 Generic CP Handles (Pair) **7.63**

For UNION BRASS
TUB & SHOWER DIVERTER

(1380)



18 PT.

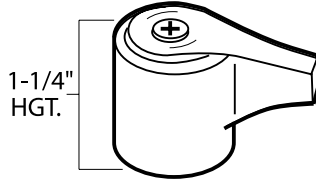

1-1/4"
HGT.

29-525D Generic CP Handle (Each) **5.85**

For UNION BRASS
LAVATORY & KITCHEN

(1377H)
(1377C)



18 PT.

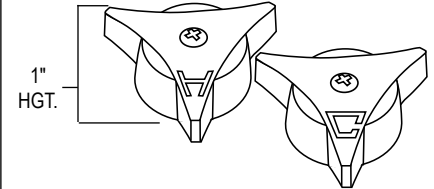

1"
HGT.

29-528 Generic CP Handles (Pair) **11.78**

For VALLEY
LAVATORY, TUB & SHOWER

(V6679)

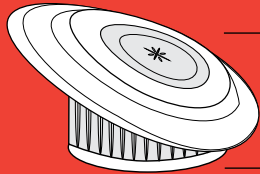

1-3/8"
HGT.

• Fits model numbers starting with "A" and "L"

OLD STYLE

21-492 Generic Acrylic Handle (Each) **5.86**

For VALLEY
LAVATORY

(V5002)

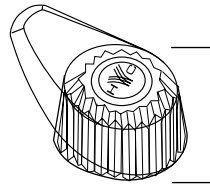

1-5/8"
HGT.

• Clear acrylic handle for chrome or polished brass single handle lavatory faucets

NEW STYLE

21-488 Generic Acrylic Handle (Each) **5.86**

For UNION BRASS
TUB & SHOWER

(1379H)
(1379C)



18 PT.

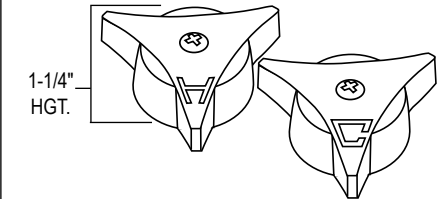

1-1/4"
HGT.

29-529 Generic CP Handles (Pair) **14.15**

For VALLEY
LAVATORY, KITCHEN & BAR

(V1165)

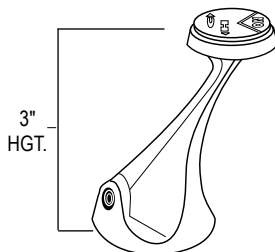

3"
HGT.

• Fits model numbers starting with "L"

21-490 Generic CP Handle (Each) **7.07**

For VALLEY
LAVATORY & KITCHEN

(V7800)

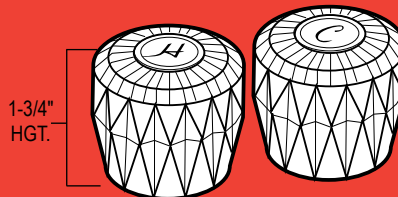

1-3/4"
HGT.

STARFIRE

22-846 Generic Acrylic Handles (Pair) **6.77**

For VALLEY
TUB & SHOWER

(V7815)

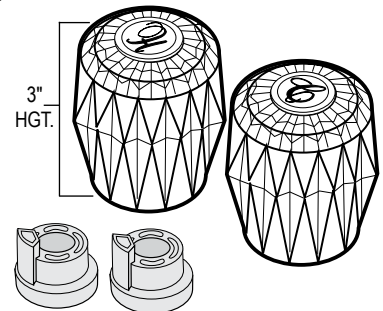

3"
HGT.

(INSERTS INCLUDED)

STARFIRE

22-849 Generic Acrylic Handles (Pair) **11.78**

USE YOUR CREDIT CARD AT TIME OF PURCHASE AND SAVE 2% ON ALL ORDERS, SAVE 5% ON ALL ORDERS OVER \$500 OR SAVE 10% ON ALL ORDERS OVER \$1000

FAX 1-800-982-5934

www.HODES CO.com
PREFERRED PLUMBING PRODUCTS

PHONE 1-800-777-6500

FAUCETS AND EXTERNAL TRIM



HANDLE BUTTONS

Case Lot Pricing
available at
www.HodesCo.com

For AMERICAN STANDARD (55906-02)
(066313-002A)
LAVATORY, KITCHEN, TUB & SHOWER 5/8" TOP DIA.

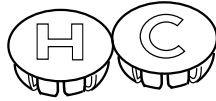

*Not Available From American Standard
FLORENTINE/ CROWN
SOLD 5 PER PACKAGE ONLY
22-604H *Generic CP Hot Button **.62¢**
22-604C *Generic CP Cold Button **.62¢**

BRIGGS (F129)
LAVATORY, TUB & SHOWER

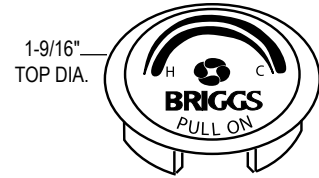

1-9/16" TOP DIA.
22-071 Genuine Acrylic Button **2.25**

DELTA FAUCET COMPANY (RP20542)
GENUINE PARTS
TUB & SHOWER



• 1-1/2" diameter
• Silver insert with red/blue indicators
• For 1300, 1400 & 1600 series
22-242 Genuine Button **3.26**

DELTA FAUCET COMPANY (RP17655)
GENUINE PARTS
TUB & SHOWER

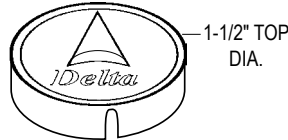

• For 1600 series
SCALDGUARD
22-599 Genuine Acrylic Button **2.32**

DELTA FAUCET COMPANY (RP17446)
GENUINE PARTS
LAVATORY, TUB & SHOWER



1-1/2" TOP DIA.
22-241 Genuine Acrylic Button **3.20**

DELTA FAUCET COMPANY (RP2411)
GENUINE PARTS
LAVATORY, TUB & SHOWER

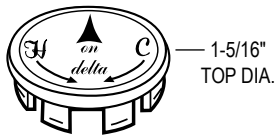

OLD STYLE
23-308 Genuine Acrylic Button **3.20**

DELTA FAUCET COMPANY (RP5692)
GENUINE PARTS
LAVATORY, KITCHEN, TUB & SHOWER

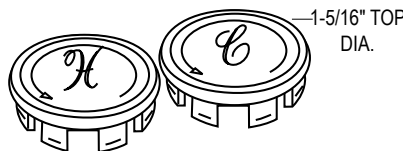

SOLD AS PAIR ONLY
23-312 Genuine Acrylic Hot and Cold Button . **4.45**

DELTA FAUCET COMPANY (RP18372)
GENUINE PARTS (RP18373)
WIDESPREAD LAVATORY,
TUB & SHOWER

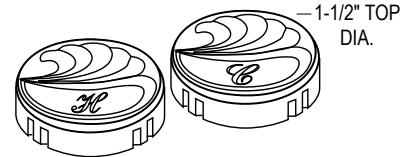

23-537H Genuine Acrylic Hot Button **1.95**
23-537C Genuine Acrylic Cold Button **1.95**

DELTA FAUCET COMPANY (RP21912)
GENUINE PARTS (RP21915)
LAVATORY



• With hot and cold color indicators
22-045H Genuine Acrylic Hot Button **2.32**
22-045C Genuine Acrylic Cold Button **2.32**

For GERBER (94-445)
(94-446)
LAVATORY, KITCHEN, TUB & SHOWER (94-447)

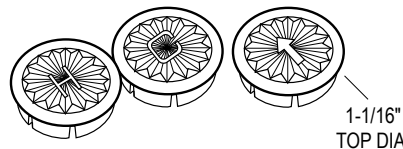

SOLD 5 PER PACKAGE ONLY
22-063H Generic Acrylic Hot Button **1.32**
22-063C Generic Acrylic Cold Button **1.32**
22-063D Generic Acrylic Diverter Button **1.32**

HONOR THY PLUMBER™

USE YOUR CREDIT CARD AT TIME OF PURCHASE AND SAVE 2% ON ALL ORDERS, SAVE 5% ON ALL ORDERS OVER \$500 OR SAVE 10% ON ALL ORDERS OVER \$1000

FAX 1-800-982-5934 www.HODESCO.com PHONE 1-800-777-6500
268



HANDLE BUTTONS



FAUCETS AND EXTERNAL TRIM

HONOR THY PLUMBER™

For KOHLER (30000)
LAVATORY, KITCHEN, TUB & SHOWER

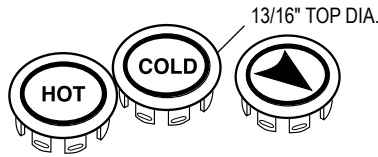

SOLD 5 PER PACKAGE ONLY

- 22-035H Generic Acrylic Hot Button **.90¢**
- 22-035D Generic Acrylic Diverter Button **.90¢**
- 22-036D Genuine Acrylic Diverter Button **1.97**

For MOEN (15613)

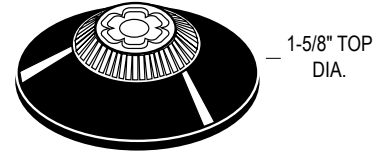

- 22-055 Generic Plastic Button **1.17**
- 22-058 Genuine Plastic Button **6.46**

For MOEN
LAVATORY, KITCHEN, TUB & SHOWER

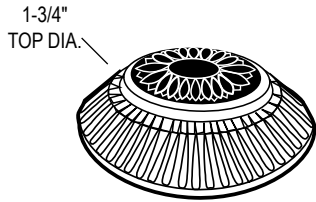

NOT AVAILABLE FROM MOEN

- 22-050 Generic Plastic Button **1.17**

PRICE PFISTER (941-045A)
LAVATORY, TUB & SHOWER



- 22-075 Genuine Acrylic Button **6.47**

For PRICE PFISTER (941-330)
LAVATORY, KITCHEN, TUB & SHOWER (941-320)
(941-340)

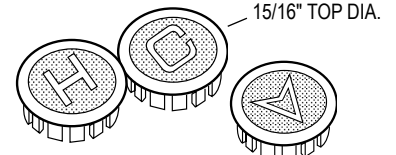

SOLD 5 PER PACKAGE ONLY

- 22-267H Generic Acrylic Hot Button **.31¢**
- 22-267C Generic Acrylic Cold Button **.31¢**
- 22-267D Generic Acrylic Diverter Button **.31¢**

PRICE PFISTER (941-330A)
LAVATORY, KITCHEN, TUB & SHOWER (941-320A)
(941-340A)

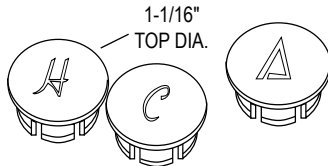

WINDSOR

- 22-067H Genuine CP Hot Button **1.49**
- 22-067C Genuine CP Cold Button **1.49**
- 22-068D Genuine CP Diverter Button **1.49**

For SAYCO
LAVATORY, KITCHEN, TUB & SHOWER

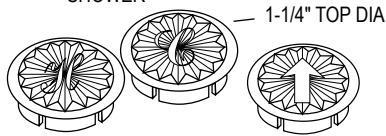

*Not Available From Sayco

SOLD 5 PER PACKAGE ONLY

- 22-048H Generic Acrylic Hot Button **.31¢**
- 22-048C Generic Acrylic Cold Button **.31¢**
- 22-048D Generic Acrylic Diverter Button **.31¢**

For STERLING (99B1961)
(99B1962)

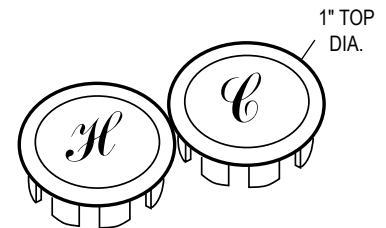

SOLD 5 PER PACKAGE ONLY

- 22-090H Generic Acrylic Hot Button **.31¢**
- 22-090C Generic Acrylic Cold Button **.31¢**

STERLING

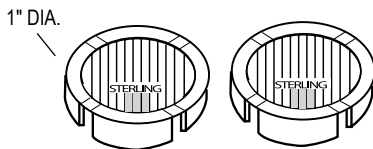

• Acrylic
• Priced per each

SOLD 5 PER PACKAGE ONLY

- 22-728C Genuine 1" Cold Button **.90¢**
- 22-728H Genuine 1" Hot Button **.90¢**

For STERLING
LAVATORY, KITCHEN, TUB & SHOWER

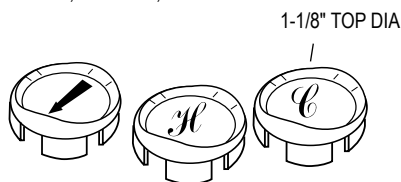

SOLD 5 PER PACKAGE ONLY

- 22-093H Generic Acrylic Hot Button **.57¢**
- 22-093C Generic Acrylic Cold Button **.57¢**
- 22-093D Generic Acrylic Diverter Button **.57¢**

STERLING

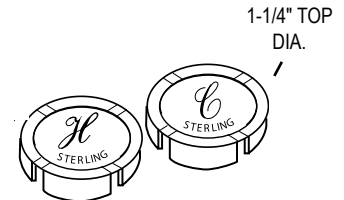

- 22-091H Genuine Acrylic Hot Button **.90¢**
- 22-091C Genuine Acrylic Cold Button **.90¢**
- 22-091D Genuine Acrylic Diverter Button **.90¢**

USE YOUR CREDIT CARD AT TIME OF PURCHASE AND SAVE 2% ON ALL ORDERS, SAVE 5% ON ALL ORDERS OVER \$500 OR SAVE 10% ON ALL ORDERS OVER \$1000

1-800-982-5934 Fax **www.HODESCO.com** Phone **1-800-777-6500**
PROFFERED PLUMBING PRODUCTS **269**

HANDLE BUTTONS

FAUCETS AND EXTERNAL TRIM



FAUCET HANDLE SCREWS

3/8" x 10-32

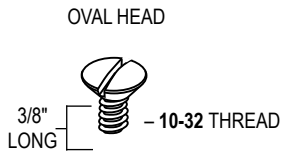

SOLD 25 PER PACKAGE ONLY

20-803 CP Handle Screw **.27¢**

1/2" x 8-32

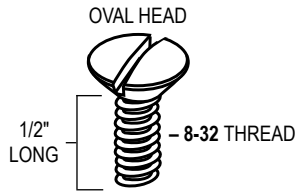

SOLD 25 PER PACKAGE ONLY

20-813 CP Handle Screw **.27¢**

1/2" x 10-32

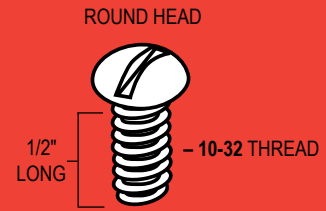

SOLD 25 PER PACKAGE ONLY

20-290 CP Handle Screw **.27¢**

1/2" x 8/32 (T-32)

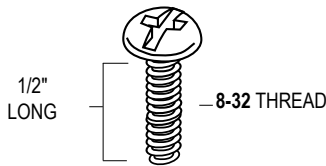

- 1/2" x 8/32" thread
- For Symmons single lever T-31 handle (our #21-305 & 21-805)

SOLD 25 PER PACKAGE ONLY

20-294 CP Round Head Handle Screw **.32¢**

1/2" x 10-24

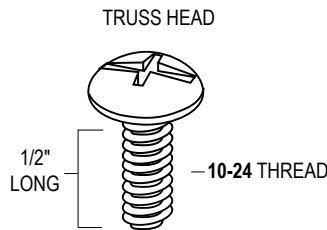

SOLD 25 PER PACKAGE ONLY

20-811 CP Handle Screw **.32¢**

1/2" x 10-24

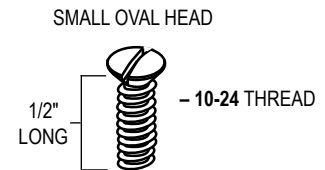

SOLD 25 PER PACKAGE ONLY

20-815 CP Handle Screw **.27¢**

HANDLE SCREWS

DELTA FAUCET COMPANY GENUINE PARTS
1/2" x 10-24 (RP13159)

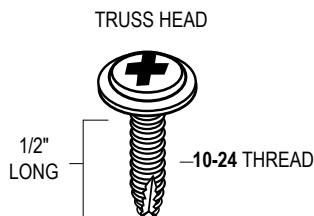

SOLD 10 PER PACKAGE ONLY

23-314 Genuine CP Handle Screw **.42¢**

DELTA FAUCET COMPANY GENUINE PARTS
1/2" x 10-24 (RP17042)

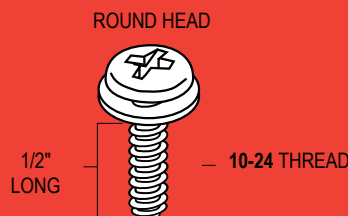

SOLD 5 PER PACKAGE ONLY

23-344 Genuine CP Handle Screw **.90¢**

PRICE PFISTER (971-600A)
1/2" x 10-24

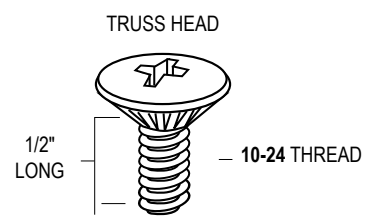

SOLD 5 PER PACKAGE ONLY

20-832 Genuine CP Handle Screw **.60¢**

USE YOUR CREDIT CARD AT TIME OF PURCHASE AND SAVE 2% ON ALL ORDERS, SAVE 5% ON ALL ORDERS OVER \$500 OR SAVE 10% ON ALL ORDERS OVER \$1000

FAX 1-800-982-5934 www.HODESCO.com PHONE 1-800-777-6500
 270



FAUCET HANDLE SCREWS



FAUCETS AND EXTERNAL TRIM

1/2" x 10-32

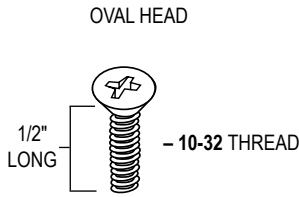

SOLD 25 PER PACKAGE ONLY

20-816 CP Handle Screw **.32¢**

1/2" x 10-32

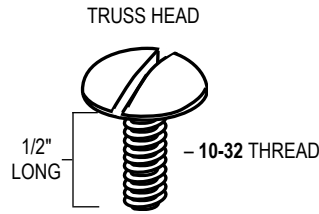

SOLD 25 PER PACKAGE ONLY

20-806 CP Handle Screw **.43¢**

1/2" x 10-24

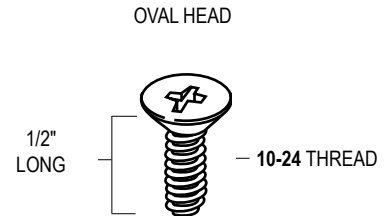

SOLD 25 PER PACKAGE ONLY

20-807 CP Handle Screw **.38¢**

3/4" x 10-24

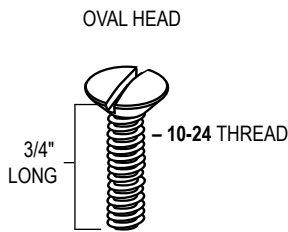

SOLD 25 PER PACKAGE ONLY

20-819 CP Handle Screw **.32¢**

3/4" x 10-32

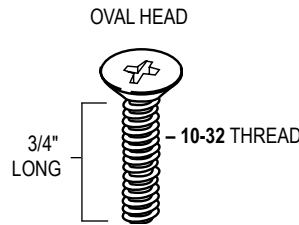

SOLD 25 PER PACKAGE ONLY

20-817 CP Handle Screw **.32¢**

1" x 10-24

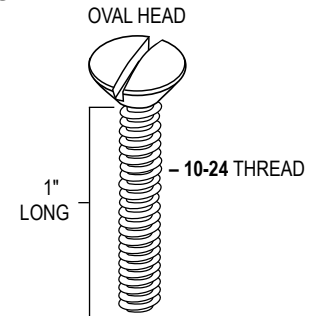

SOLD 25 PER PACKAGE ONLY

20-821 CP Handle Screw **.23¢**

1" x 8-32

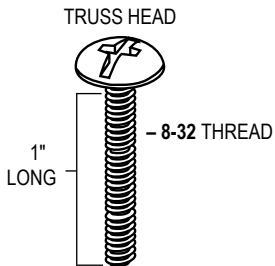

SOLD 25 PER PACKAGE ONLY

20-824 CP Handle Screw Round Head **.23¢**

20-825 CP Handle Screw Truss Head **.23¢**

1-1/2" x 10-24

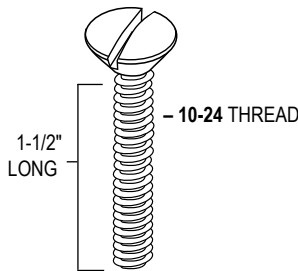

SOLD 25 PER PACKAGE ONLY

20-830 CP 1-1/2" x 10-24 Oval Head **.23¢**

1-3/4" x 10-32

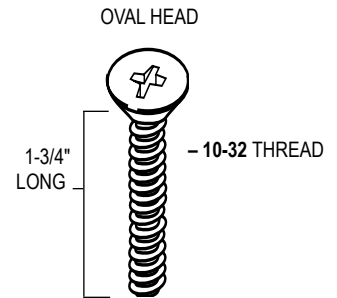

SOLD 25 PER PACKAGE ONLY

20-888 CP 1-3/4" x 10-32 Oval Head **.76¢**



www.HodesCo.com

CHROMED HANDLE SCREW ASSORTMENT KIT

- 300 assorted chrome plated handle screws
- 12 different sizes

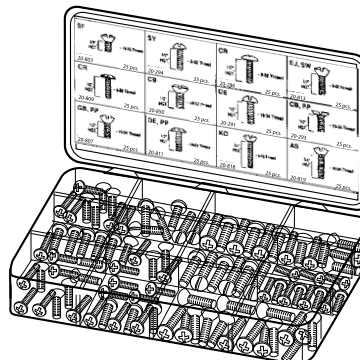

SEE OTHER BOXED REPAIR KITS ON PAGES 289-295

20-839 300 Pc. Assortment Kit **64.30**

USE YOUR CREDIT CARD AT TIME OF PURCHASE AND SAVE 2% ON ALL ORDERS, SAVE 5% ON ALL ORDERS OVER \$500 OR SAVE 10% ON ALL ORDERS OVER \$1000

FAX 1-800-982-5934 www.HODES CO.com PHONE 1-800-777-6500



HANDLE SCREWS