

BUY WITH CONFIDENCE.

Over 10,000 items shipped the same day from our ISO 9001:2000 quality certified facility. From Advantage to Shome, we sell the best products at the best possible prices and back them with our 100% satisfaction guarantee.

INTERNAL FAUCET REPAIR

For
**AMERICAN
STANDARD**

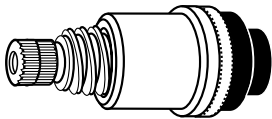

SEE PAGE 274

28-149R

28-149L

For
SAYCO

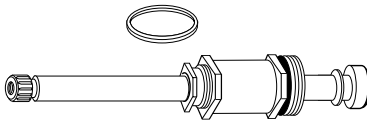

SEE PAGE 289

28-637R

28-637L

For
PRICE PFISTER

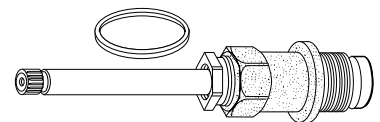

SEE PAGE 288

28-660R

For
CRANE

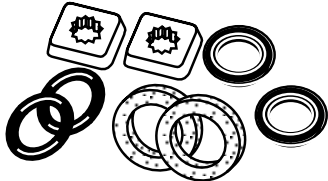

SEE PAGE 295

21-122

Symmons

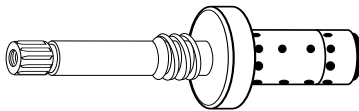

SEE PAGE 291

26-969

DELTA
FAUCET COMPANY
GENUINE PARTS

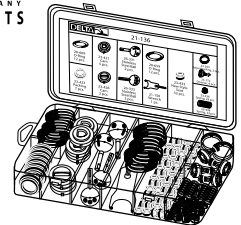

SEE PAGE 308

21-136

STERLING

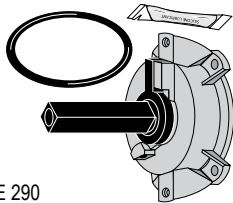

SEE PAGE 290

26-200

DELTA
FAUCET COMPANY
GENUINE PARTS

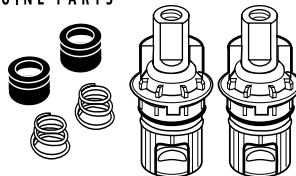

SEE PAGE 298

23-401

Multi-Colored Buna-N (nitrile)
Bibb Washer Assortment Chest

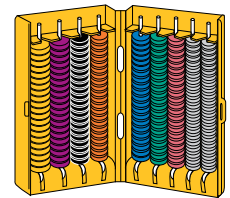

SEE PAGE 311

20-966

For
GERBER

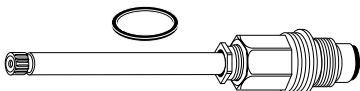

SEE PAGE 281

28-695R

For
KOHLER

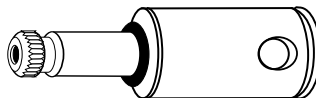

SEE PAGE 283

28-460L

28-460R

MOEN



SEE PAGE 285

26-901

USE YOUR CREDIT CARD AT TIME OF PURCHASE AND **SAVE 2%** ON ALL ORDERS,
SAVE 5% ON ALL ORDERS OVER \$500 OR **SAVE 10%** ON ALL ORDERS OVER \$1000

FAX
1-800-982-5934 www.**HODES CO**.com PHONE
272 **1-800-777-6500**
PREFERRED PLUMBING PRODUCTS

CARTRIDGES AND STEMS (IN ALPHABETICAL ORDER AND LENGTH)



INTERNAL FAUCET REPAIR



(2305-1001)

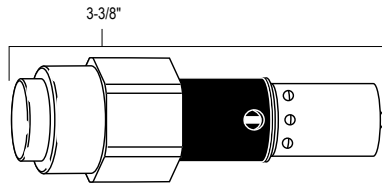

26-201 Genuine Cartridge Assembly **46.73**

ADVANTAGE™ INTERNAL REPAIR KIT



- Contains all parts required to rebuild and repair Advantage™ Faucets #18-100, 18-101, 18-102, 18-103 and pre rinse units #18-110, 18-111, 18-112
- Interchangeable with other major brand faucets
- Complies with all low lead requirements of NSF 61 and California proposition 61

28-125L Genuine Cold Side Repair Kit **23.60**
28-125R Genuine Hot Side Repair Kit **23.60**

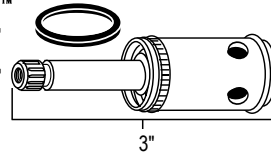

For ALTMANS

(OLC3 JK)
(OLC4 JK)



16 PT.



• One per bar coded display bag **NEW**
26-341 Generic Ceramic RH Hot Stem **29.75**
26-340 Generic Ceramic LH Cold Stem **29.75**

For ALTMANS**

(OLC3 CI)
(OLC4 CI)



16 PT.

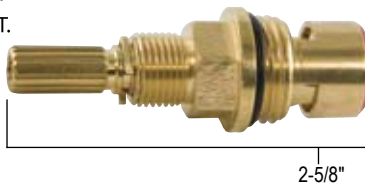

• One per bar coded display bag **NEW**
26-363 Generic Ceramic RH Hot Stem **29.75**
26-364 Generic Ceramic LH Cold Stem **29.75**

Case Lot Pricing
available at
www.HodesCo.com

For AMERICAN BRASS

(1806R)
(1806L)



17 PT.

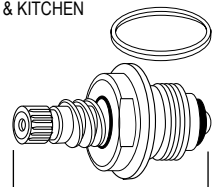

* Not available from American Brass
• One per bar coded display bag
28-110R *Generic RH Hot Stem **5.37**
28-110L *Generic LH Cold Stem **5.37**

American Standard

(57864-07)

LAVATORY, KITCHEN, TUB & SHOWER

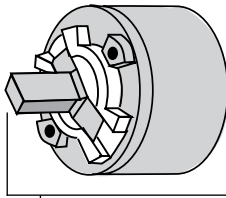

• 4.0 GPM
• One per bar coded display bag
26-203 Genuine Cartridge **55.27**

American Standard

(23529-007)

TUB & SHOWER

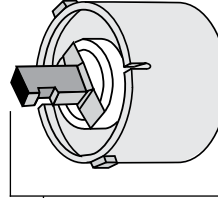

• Bidet & Electronic
• One per bar coded display bag
26-205 Genuine Cartridge **40.70**

American Standard

(66269-007)

TUB & SHOWER

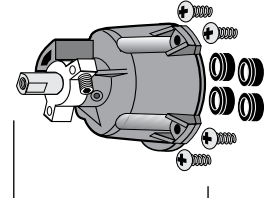

• One per bar coded display bag **WITH SEALS**
26-206 Genuine Cartridge **64.73**

American Standard

(10532-007)

TUB & SHOWER

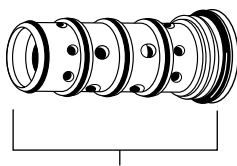

• Stainless steel piston & body
• Solid brass slotted hub
• One per bar coded display bag
26-285 Genuine Balancing Spool **70.80**

For AMERICAN STANDARD

(64803-07)

(50636-07)



16 PT.

LAVATORY & KITCHEN

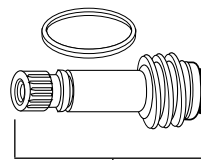

* Not available from American Standard
• One per bar coded display bag **COLONY**
28-130R *Generic RH Hot Stem **3.51**
28-130L *Generic LH Cold Stem **3.51**

For AMERICAN STANDARD

(66288-07)

(34597-07)



16 PT.

LAVATORY, KITCHEN, TUB & SHOWER

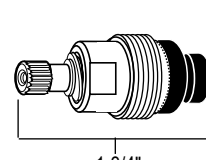

• One per bar coded display bag **CADET**
28-143R Generic RH Hot Stem **4.70**
28-143L Generic LH Cold Stem **4.70**

**USE YOUR CREDIT CARD AT TIME OF PURCHASE AND SAVE 2% ON ALL ORDERS,
SAVE 5% ON ALL ORDERS OVER \$500 OR SAVE 10% ON ALL ORDERS OVER \$1000**

FAX 1-800-982-5934 www.HODES CO.com PHONE 1-800-777-6500



INTERNAL FAUCET REPAIR



CARTRIDGES AND STEMS
(IN ALPHABETICAL ORDER AND LENGTH)

For AMERICAN STANDARD (61268-04) (61261-04)
LAVATORY, KITCHEN, TUB & SHOWER

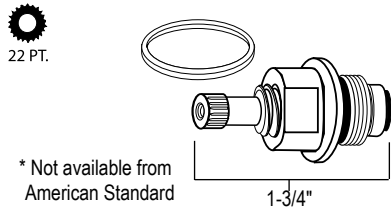

* Not available from American Standard
• One per bar coded display bag

R. SERIES

- 28-140R *Generic RH Hot Stem **8.01**
- 28-140L *Generic LH Cold Stem **8.01**

For AMERICAN STANDARD
LAVATORY, KITCHEN, TUB & SHOWER

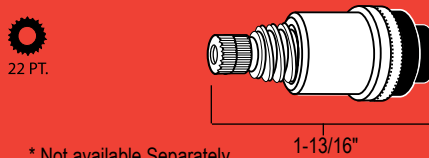

* Not available Separately from American Standard
• One per bar coded display bag

AQUASEAL

- 28-149R *Generic RH Hot Stem **4.34**
- 28-149L *Generic LH Cold Stem **4.34**

For AMERICAN STANDARD (72950-17) (72951-07)
LAVATORY, KITCHEN, TUB & SHOWER

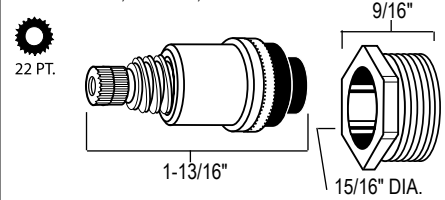

• One per bar coded display bag

AQUASEAL

- 28-145R Generic RH Hot Stem w/Locknut... **5.45**
- 28-145L Generic LH Cold Stem w/Locknut... **5.45**

For AMERICAN STANDARD (855-17)
LAVATORY, KITCHEN, TUB & SHOWER

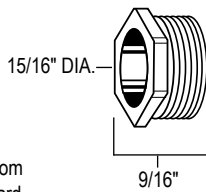

* Not available from American Standard
• One per bar coded display bag

AQUASEAL

- 21-516 *Generic Locknut Only **1.61**

For AMERICAN STANDARD
LAVATORY, KITCHEN, TUB & SHOWER

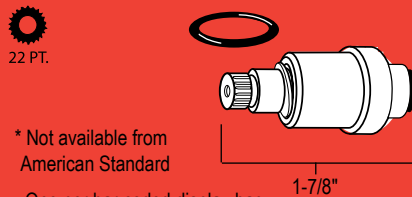

* Not available from American Standard
• One per bar coded display bag

R. SERIES

- 28-179R *Generic RH Hot Stem **4.22**
- 28-179L *Generic LH Cold Stem **4.22**

For AMERICAN STANDARD (6079-04) (6080-04)
LAVATORY, KITCHEN, TUB & SHOWER

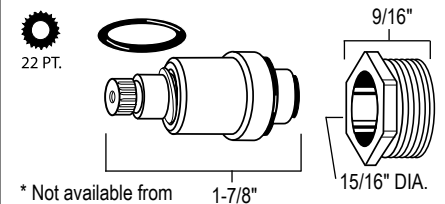

* Not available from American Standard
• One per bar coded display bag

R. SERIES

- 28-175R *Generic RH Hot Stem w/Locknut... **5.34**
- 28-175L *Generic LH Cold Stem w/Locknut... **5.34**

For AMERICAN STANDARD (951764-007A)

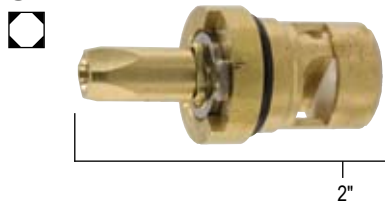

• One per bar coded display bag

NEW

- 26-343 Generic Ceramic RH Hot Stem... **27.72**
- 26-344 Generic Ceramic LH Cold Stem... **27.72**

For AMERICAN STANDARD (64702-07) (64701-07)
LAVATORY & KITCHEN

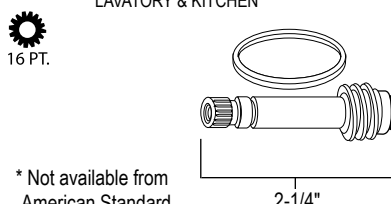

* Not available from American Standard

• One per bar coded display bag

COLONY

- 28-340R *Generic RH Hot Stem **4.68**
- 28-340L *Generic LH Cold Stem **4.68**

For AMERICAN STANDARD (994053-0070A)

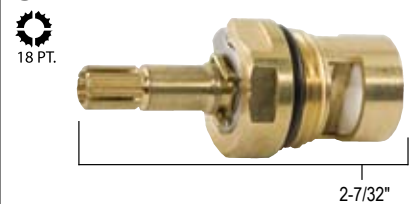

• One per bar coded display bag

NEW

- 26-355 Generic Ceramic RH Hot Stem... **22.20**
- 26-356 Generic Ceramic LH Cold Stem... **22.20**

For AMERICAN STANDARD** (28610-0070A)

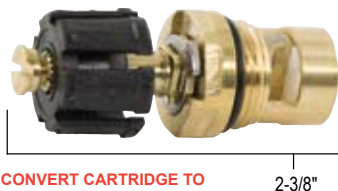

**** TO CONVERT CARTRIDGE TO TURN IN OPPOSITE DIRECTION, REMOVE CLIP, PULL AND ROTATE VALVE STEM 90°, THEN REINSERT**

NEW

- One per bar coded display bag
- 26-359 Generic Ceramic LH Cold Stem... **30.91**

For AMERICAN STANDARD (72971-04) (72977-04)
LAVATORY, KITCHEN, TUB & SHOWER

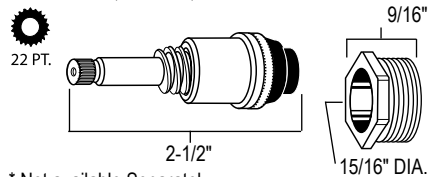

* Not available Separately from American Standard

• One per bar coded display bag

LONG PATTERN AQUASEAL

- 28-274R *Generic RH Hot Stem w/Locknut... **10.98**
- 28-274L *Generic LH Cold Stem w/Locknut... **10.98**



www.HodesCo.com

USE YOUR CREDIT CARD AT TIME OF PURCHASE AND SAVE 2% ON ALL ORDERS, SAVE 5% ON ALL ORDERS OVER \$500 OR SAVE 10% ON ALL ORDERS OVER \$1000

FAX 1-800-982-5934 www.HODESCO.com PHONE 1-800-777-6500
274



STEMS BY MFR.

CARTRIDGES AND STEMS (IN ALPHABETICAL ORDER AND LENGTH)



INTERNAL FAUCET REPAIR

For AMERICAN STANDARD (50729-07)
TUB & SHOWER



16 PT.

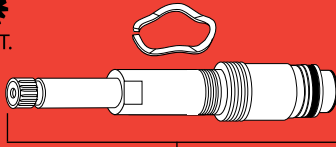

4-3/8"

* Not available from American Standard

• One per bar coded display bag

**SHORT
PATTERN
COLONY**

28-640R *Generic RH Hot or Cold Stem . . . 9.20

For AMERICAN STANDARD
TUB & SHOWER



22 PT.

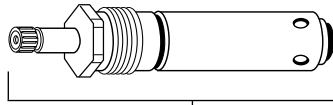

4-1/2"

* Not available from American Standard

• One per bar coded display bag

28-726D *Generic Diverter Stem 25.96

For AMERICAN STANDARD (50722-07)
TUB & SHOWER



16 PT.

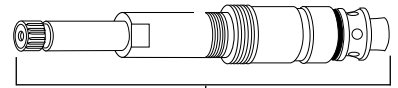

5"

* Not available from American Standard

• One per bar coded display bag

**SHORT
PATTERN
COLONY**

28-821D *Generic Diverter Stem 16.42

For AMERICAN STANDARD (72855-07)
TUB & SHOWER



16 PT.

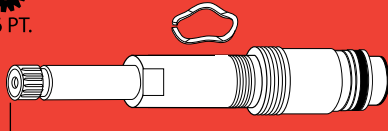

5-1/8"

* Not available from American Standard

• One per bar coded display bag

**LONG
PATTERN
COLONY**

28-705R *Generic RH Hot or Cold Stem . 11.63

For AMERICAN STANDARD (9806-02)
TUB & SHOWER



12 PT.

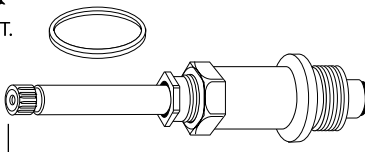

5-1/4"

* Not available from American Standard

• One per bar coded display bag

28-838R *Generic RH Hot or Cold Stem . . . 16.70

For AMERICAN STANDARD
TUB & SHOWER



22 PT.

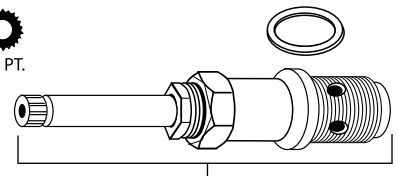

5-1/4"

* Not available from American Standard

• One per bar coded display bag

28-839D *Generic Diverter 20.81

For AMERICAN STANDARD (31344-04) (21666-02)
TUB & SHOWER



22 PT.

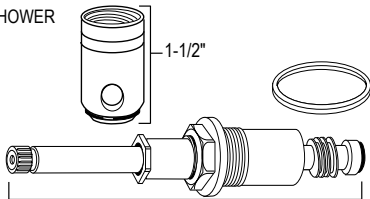

1-1/2"

5-1/4"

* Not available from American Standard

• One per bar coded display bag

28-725R *Generic RH Hot or Cold Stem Comp . 29.26

28-725L *Generic LH Cold Stem Complete . 29.26

For AMERICAN STANDARD (20336-08) (20563-08)
TUB & SHOWER



7/8" DIA.

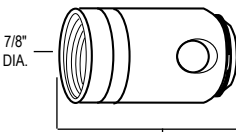

1-1/2"

* Not available from American Standard

• One per bar coded display bag

26-300 *Generic Hot Barrel 3.87

26-301 *Generic Cold Barrel 3.87

• Use with 28-420 & 28-725 stems

For AMERICAN STANDARD (72856-07)
TUB & SHOWER



16 PT.

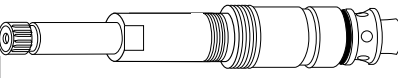

5-3/4"

* Not available from American Standard

• One per bar coded display bag

28-929D *Generic Diverter Stem 20.01

For ARTISTIC BRASS



12 PT.



2"

• One per bar coded display bag

NEW

26-385 Generic Ceramic RH Hot Stem . . . 38.02

26-386 Generic Ceramic LH Cold Stem . . 38.02

For ARTISTIC BRASS



12 PT.



2"

• One per bar coded display bag

NEW

26-387 Generic Ceramic RH Hot Stem . . . 38.02

26-388 Generic Ceramic LH Cold Stem . . 38.02



**PAY BY MAJOR CREDIT CARD
WHEN YOU PLACE YOUR ORDER
AND SAVE UP TO AN
ADDITIONAL 10%
OFF OUR ALREADY
INDUSTRY-LOW PRICES!!**

**USE YOUR CREDIT CARD AT TIME OF PURCHASE AND SAVE 2% ON ALL ORDERS,
SAVE 5% ON ALL ORDERS OVER \$500 OR SAVE 10% ON ALL ORDERS OVER \$1000**

FAX 1-800-982-5934 www.HODESCO.com PHONE 1-800-777-6500
PROFFERED PLUMBING PRODUCTS 275

STEMS BY MFR.

INTERNAL FAUCET REPAIR



PAY BY MAJOR CREDIT CARD WHEN YOU PLACE YOUR ORDER AND SAVE UP TO AN ADDITIONAL 10% OFF OUR ALREADY INDUSTRY-LOW PRICES!!

CARTRIDGES AND STEMS
(IN ALPHABETICAL ORDER AND LENGTH)

For BRIGGS (BRADLEY, SAYCO, KOHLER) (P303)
LAVATORY, KITCHEN, TUB & SHOWER

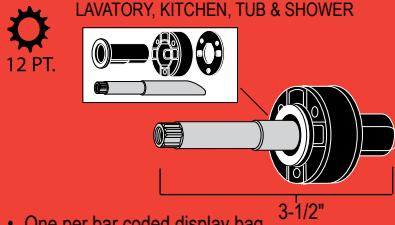

• One per bar coded display bag
26-820 Generic Cartridge 4.61

BRIGGS (P303)
LAVATORY, KITCHEN, TUB & SHOWER

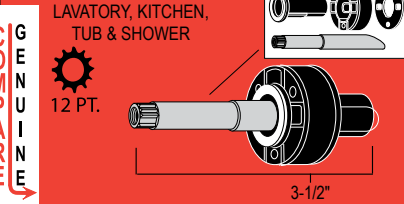

• One per bar coded display bag
26-920 Genuine Cartridge 10.32

GENUINE COMPARE

For BRIGGS (BRADLEY, SAYCO) (P301)
LAVATORY, KITCHEN, TUB & SHOWER

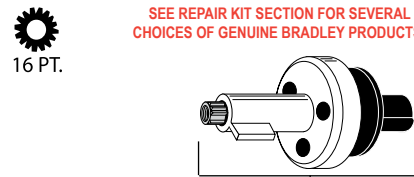

• One per bar coded display bag
26-922 Generic Cartridge 7.97

SEE REPAIR KIT SECTION FOR SEVERAL CHOICES OF GENUINE BRADLEY PRODUCTS!

For BRIGGS (505)
TUB & SHOWER

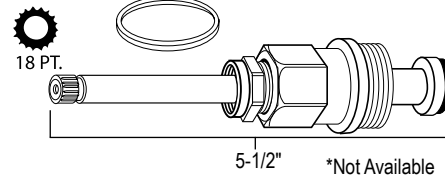

• One per bar coded display bag
28-720R *Generic RH Hot or Cold Stem . . . 19.78

*Not Available From Briggs

For BROADWAY** (26.99204 605) (26.99203 605)
TUB & SHOWER



• One per bar coded display bag
26-371 Generic Ceramic RH Hot Stem . . . 36.79
26-372 Generic Ceramic LH Cold Stem . . . 36.79

NEW

For CENTRAL (ROYAL BRASS) (50357KRH) (50357KLH)
LAVATORY

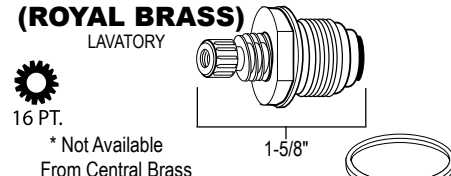

* Not Available From Central Brass
• One per bar coded display bag
28-045R *Generic RH Hot Stem 4.38
28-045L *Generic LH Cold Stem 4.38

For CENTRAL (SU-353-ER) (SU-353-EL)
LAVATORY

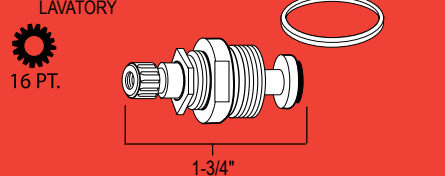

• One per bar coded display bag
28-040R Generic RH Stem 3.50
28-040L Generic LH Stem 3.50

For CENTRAL BRASS (K-158-KR) (K-158-KL)
LAVATORY

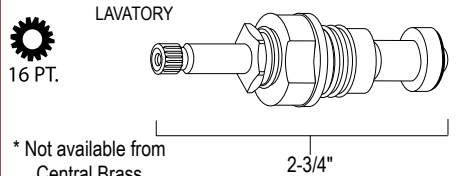

* Not available from Central Brass
• One per bar coded display bag
28-440R *Generic RH Hot Stem 13.02
28-440L *Generic LH Cold Stem 13.02

For CENTRAL BRASS (K-3-CT)
TUB & SHOWER

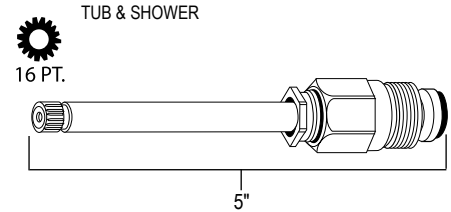

• One per bar coded display bag
28-810R Generic RH Hot or Cold Stem . . . 17.49

Central Brass (K-3-DT)
TUB & SHOWER

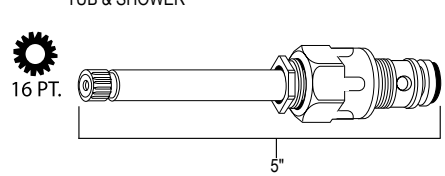

• One per bar coded display bag
28-813D Genuine Diverter Stem 30.62

For CENTRAL BRASS (K-351-C)
TUB & SHOWER



• One per bar coded display bag
26-477 *Genuine RH Ceramic Hot Stem . . 32.15
26-478 *Genuine LH Ceramic Cold Stem . 32.15

NEW

For CENTRAL (K-2-DT)
TUB & SHOWER

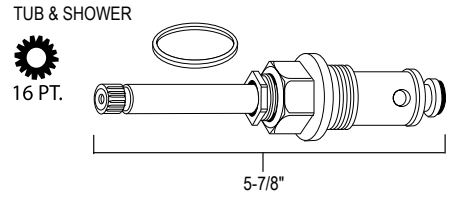

• One per bar coded display bag
28-806D Generic Diverter Stem 17.69

For CENTRAL (K-2-CS)
TUB & SHOWER

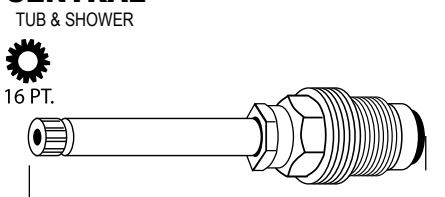

• One per bar coded display bag
28-800R Generic RH Hot or Cold Stem . . . 17.90

For CENTRAL (K-2-CT)
TUB & SHOWER

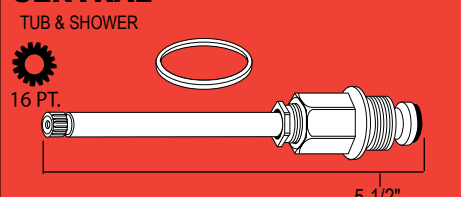

• One per bar coded display bag
28-700R Generic RH Hot or Cold Stem . . 12.62

USE YOUR CREDIT CARD AT TIME OF PURCHASE AND SAVE 2% ON ALL ORDERS, SAVE 5% ON ALL ORDERS OVER \$500 OR SAVE 10% ON ALL ORDERS OVER \$1000

1-800-982-5934 FAX **www.HODESCO.com** PHONE **1-800-777-6500**
276 **PROFERRED PLUMBING PRODUCTS**

STEMS BY INFR.

CARTRIDGES AND STEMS (IN ALPHABETICAL ORDER AND LENGTH)



INTERNAL FAUCET REPAIR



(333XJK)

LAVATORY

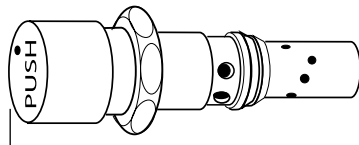

3-3/8"

- One per bar coded display bag

SELF-CLOSE

26-292 Genuine Cartridge **70.08**



(333XSLOJK-PS)

LAVATORY

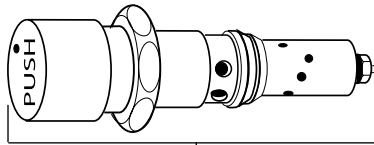

3-3/4"

- One per bar coded display bag

SLOW-CLOSE

26-293 Genuine Cartridge **70.08**

For **CHICAGO FAUCETS**
LAVATORY & KITCHEN

(1-100)
(1-099)

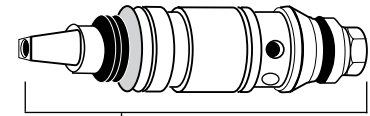

2-11/16"

* NOT AVAILABLE FROM
CHICAGO FAUCETS

OLD STYLE SHORT QUATURN

28-595R Generic RH Cold Stem (one groove) . . . **13.89**

28-595L Generic LH Hot Stem (two grooves) . . . **13.89**



A BETTER PRODUCT AT
A MUCH LOWER COST

For
CHICAGO FAUCETS

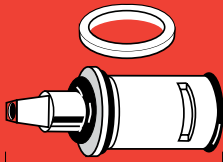

2-3/16"

- Full open to full close in just a 1/4 turn, for convenient flow control and less wear
- Unique design prevents damage caused by excess torque during installation – a common problem with other ceramic cartridges
- Interchangeable with Quaturn compression
- No threads to wear or corrode
- One per bar coded display bag

28-301R Genuine RH Cold Stem **21.11**

28-301L Genuine LH Hot Stem **21.11**



(1-100XK)
(1-099XK)

LAVATORY & KITCHEN

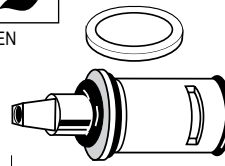

2-3/16"

- Full open to full close in just a 1/4 turn, for convenient flow control and less wear
- Unique design prevents damage caused by excess torque during installation – a common problem with other ceramic cartridges
- Interchangeable with Quaturn compression
- No threads to wear or corrode
- One per bar coded display bag

SHORT CERAMIC QUATURN

28-299R Genuine RH Cold Stem **27.68**

28-299L Genuine LH Hot Stem **27.68**



(1-099XT)
(1-100XT)

LAVATORY & KITCHEN

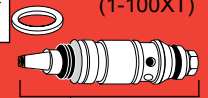

2-11/16"

- Full open to close in just 1/4 turn, for convenient flow control and less wear
- Closes with the pressure of the water, so the seat washer isn't always fighting the pressure
- Basic design has remained consistent for over 80 years - so Quaturn will always fit
- Easily and quickly renewed or replaced
- Lubricants isolated from water to prevent washing away in hot water temperature situation
- One per bar coded display bag

NEW STYLE SHORT QUATURN

28-295R Genuine RH Cold Stem **20.95**

28-295L Genuine LH Hot Stem **20.95**



A BETTER PRODUCT AT
A MUCH LOWER COST

For
CHICAGO FAUCETS
LAVATORY & KITCHEN

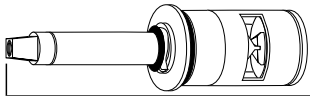

2-7/8"

- Full open to full close in just a 1/4 turn, for convenient flow control and less wear
- Unique design prevents damage caused by excess torque during installation – a common problem with other ceramic cartridges
- Interchangeable with Quaturn compression
- No threads to wear or corrode
- One per bar coded display bag

28-302R Genuine RH Cold Stem **25.61**

28-302L Genuine LH Hot Staem **25.61**



(377-XKRHJKNF)
(377-XKLHJKNF)

LAVATORY & KITCHEN

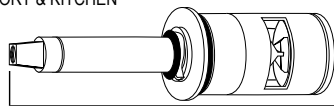

2-7/8"

- Full open to full close in just a 1/4 turn, for convenient flow control and less wear
- Unique design prevents damage caused by excess torque during installation – a common problem with other ceramic cartridges
- Interchangeable with Quaturn compression
- No threads to wear or corrode
- One per bar coded display bag

LONG CERAMIC QUATURN

28-300R Genuine RH Cold Stem **32.30**

28-300L Genuine LH Hot Stem **32.30**



(377XTRH)
(377XTLH)

TUB & SHOWER

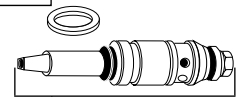

3-3/8"

- Full open to close in just 1/4 turn, for convenient flow control and less wear
- Closes with the pressure of the water, so the seat washer isn't always fighting the pressure
- Basic design has remained consistent for over 80 years - so Quaturn will always fit
- Easily and quickly renewed or replaced
- Lubricants isolated from water to prevent washing away in hot water temperature situation
- One per bar coded display bag

28-560R Genuine RH Cold Stem **26.58**

28-560L Genuine LH Hot Stem **26.58**

**USE YOUR CREDIT CARD AT TIME OF PURCHASE AND SAVE 2% ON ALL ORDERS,
SAVE 5% ON ALL ORDERS OVER \$500 OR SAVE 10% ON ALL ORDERS OVER \$1000**

FAX

1-800-982-5934

www.



.com

PHONE

1-800-777-6500

277

STEMS BY MFR.

INTERNAL FAUCET REPAIR



CARTRIDGES AND STEMS
(IN ALPHABETICAL ORDER AND LENGTH)

For CONCINITY

(1001-H)
(1001-C)



20 PT.



2-1/8"

• One per bar coded display bag

NEW

26-381 Generic Ceramic RH Hot Stem . . . **19.45**

26-382 Generic Ceramic LH Cold Stem . . . **19.45**

For CRANE

(FB12536)
(FB12535)

LAVATORY, KITCHEN, TUB & SHOWER



12 PT.

5/16" SMALL

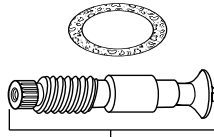

2-5/16"

• One per bar coded display bag

DIALEZE

28-388R Generic RH Cold Stem **3.50**

28-388L Generic LH Hot Stem **3.50**

For CRANE

(FB8553)
(FB8552)

LAVATORY, KITCHEN, TUB & SHOWER



12 PT.

5/16" SMALL

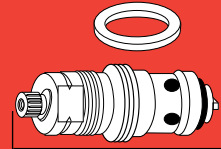

2-5/16"

• One per bar coded display bag

DIALEZE

28-425R Generic RH Cold Stem **5.65**

28-425L Generic LH Hot Stem **5.65**

For CRANE

(FB8807-H)

LAVATORY, KITCHEN, TUB & SHOWER



12 PT.

5/16" SMALL

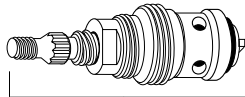

3"

• One per bar coded display bag

28-427R Generic RH Hot or Cold Stem . . . **17.57**

For CRANE

TUB & SHOWER



12 PT.

3/8" LARGE

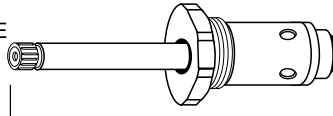

4-11/16"

* Not available from Crane

• One per bar coded display bag

28-753D *Generic Diverter **28.01**

For CRANE

(FB9261RH)

TUB & SHOWER



12 PT.

3/8" LARGE

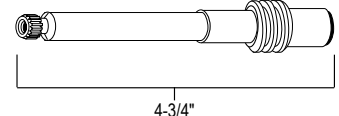

4-3/4"

• One per bar coded display bag

*Not Available From Crane

CRESTMONT

28-752R *Generic RH Hot or Cold Stem . . . **22.40**

For CRANE

(6030123)

TUB & SHOWER



12 PT.

1/2" EXTRA LARGE

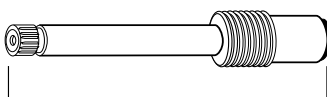

4-3/4"

*Not available from Crane

• One per bar coded display bag

RIVIERA

28-776R *Generic RH Hot or Cold Stem . . . **22.17**

For CRANE/REPCAL

(F14153)

TUB & SHOWER



12 PT.

3/8" LARGE

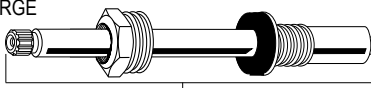

5-3/8"

*Not Available From Crane or Repcal

• With stepped shoulder

• One per bar coded display bag

28-887R *Generic RH Hot or Cold Stem . . . **22.40**

For CRANE/REPCAL

TUB & SHOWER



12 PT.

3/8" LARGE

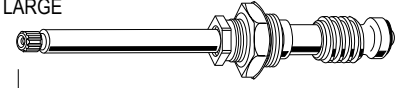

6"

*Not Available From Crane or Repcal

• One per bar coded display bag

28-957R *Generic RH Hot or Cold Stem . . . **17.11**

HONOR THY PLUMBER™



GENUINE PARTS

LAVATORY, KITCHEN, TUB & SHOWER

(RP8230)

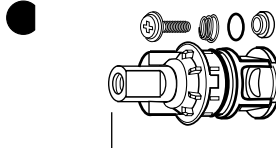

1-7/8"

• One per bar coded display bag

CERAMIC

26-415 Genuine Cartridge **21.20**



GENUINE PARTS

LAVATORY & KITCHEN

(RP25513)



1-7/8"

• For two handle faucets

• Stem assembly with 1/4 Turn Stop

23-475 Genuine Cartridge **21.12**

26-537 Genuine Cartridge w/o Plastic Stop . . **18.12**

USE YOUR CREDIT CARD AT TIME OF PURCHASE AND SAVE 2% ON ALL ORDERS, SAVE 5% ON ALL ORDERS OVER \$500 OR SAVE 10% ON ALL ORDERS OVER \$1000

1-800-982-5934 FAX **www.HODESCO.com** PHONE **1-800-777-6500**
278 **PROFERRED PLUMBING PRODUCTS**

CARTRIDGES AND STEMS (IN ALPHABETICAL ORDER AND LENGTH)



INTERNAL FAUCET REPAIR

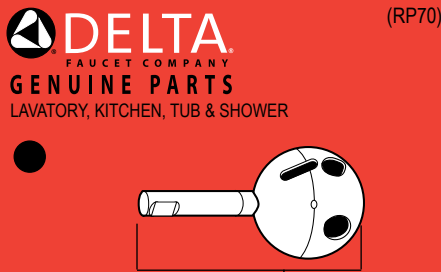

- For single lever faucets
- Stainless steel
- One per bar coded display bag

26-331 Genuine Ball Assembly 4.45



- For single knob faucets
- Stainless steel
- One per bar coded display bag

26-333 Genuine Ball Assembly 4.45

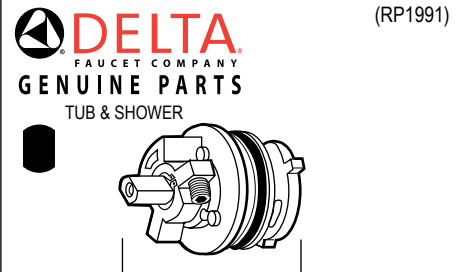

- One per bar coded display bag

26-210 Genuine Cartridge 15.53

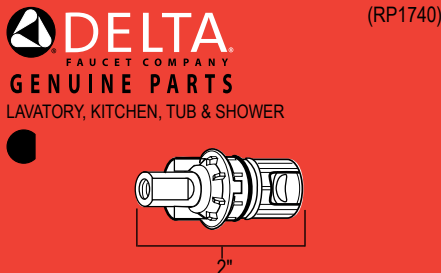

- Stainless steel bottom
- For two handle faucets
- One per bar coded display bag

26-437 Genuine Cartridge Hot or Cold 4.45



- One per bar coded display bag

26-305 Genuine Balancing Spool 66.00

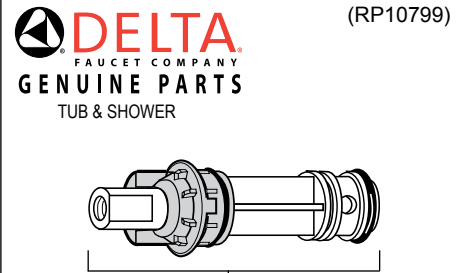

- One per bar coded display bag

26-438 Genuine Cartridge 10.88



MONITOR® 17
NEW

- One per bar coded display bag

26-208 Genuine Cartridge 77.46

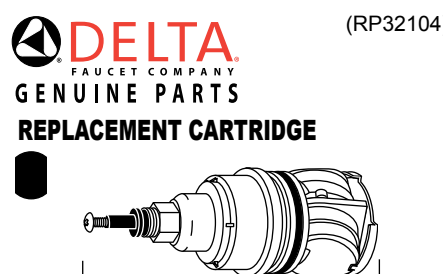

- Converts 1500 Series cartridge to new 1700 Series

26-214 Genuine Cartridge 83.51

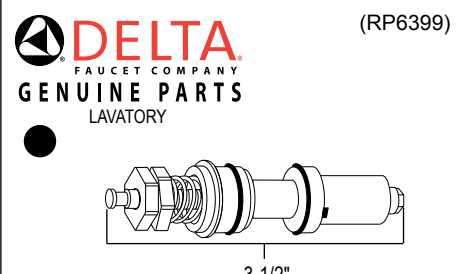

- One per bar coded display bag

26-280 Genuine Cartridge 38.92

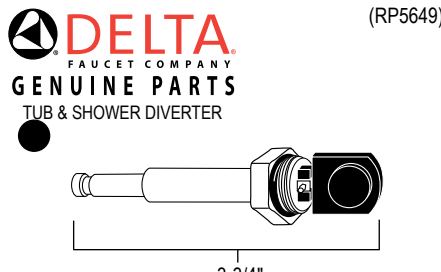

PUSH BUTTON

- One per bar coded display bag

26-311D Genuine Diverter 15.19



MONITOR® 13 & 14
NEW

- One per bar coded display bag

26-207 Genuine Cartridge 55.74

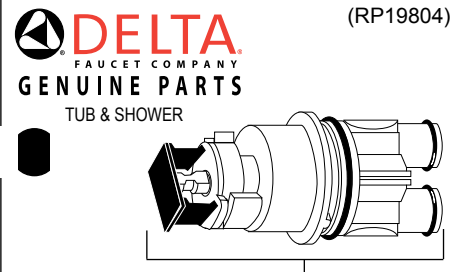

- Complete cartridge assembly with stainless steel plate
- For 1300 & 1400 series

26-211 Genuine Cartridge Assy. 35.13

**USE YOUR CREDIT CARD AT TIME OF PURCHASE AND SAVE 2% ON ALL ORDERS,
SAVE 5% ON ALL ORDERS OVER \$500 OR SAVE 10% ON ALL ORDERS OVER \$1000**

**FAX
1-800-982-5934**

www.HODES CO.com
PROFFERED PLUMBING PRODUCTS

**PHONE
1-800-777-6500
279**

STEMS BY MFR.

INTERNAL FAUCET REPAIR



CARTRIDGES AND STEMS
(IN ALPHABETICAL ORDER AND LENGTH)

9
8
7
6
5
4
3
2
STEMS BY MFR.

For ELJER (RSUX5182R) (RSUX5182L)

LAVATORY & KITCHEN

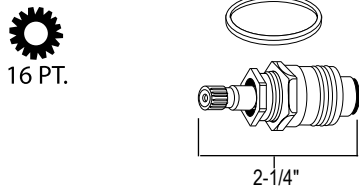

• One per bar coded display bag

28-218R Generic RH Hot Stem **9.95**
28-218L Generic LH Cold Stem **9.95**

For ELJER (490-8056-02R) (490-8056-01L)

LAVATORY & KITCHEN

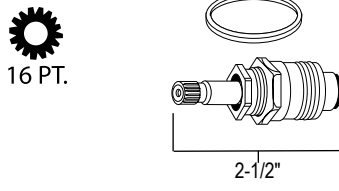

• One per bar coded display bag

28-254R Generic RH Hot Stem **10.45**
28-254L Generic LH Cold Stem **10.45**

For ELJER (5294-02)

TUB & SHOWER

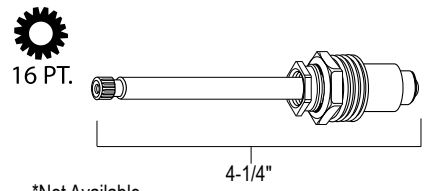

*Not Available From Eljer

• One per bar coded display bag
28-622R *Generic RH Hot or Cold Stem ... **16.62**

For ELJER (RSUX6750R)

TUB & SHOWER

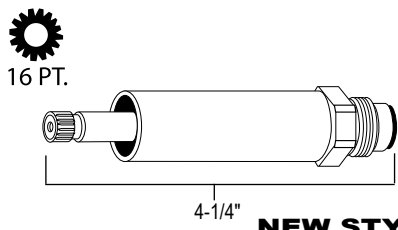

NEW STYLE

• One per bar coded display bag

28-646R Generic RH Hot Stem **15.71**

For ELJER (490-5262-00)

TUB & SHOWER

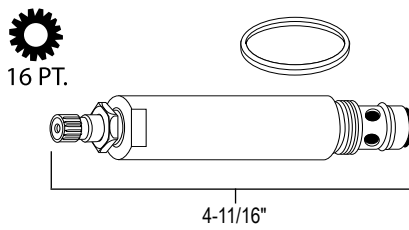

• One per bar coded display bag

28-812D Generic Diverter Stem **21.14**

For ELJER OLD# NEW#
(490-5264-02) (490-5259-01)
(490-5264-01) (490-5259-02)

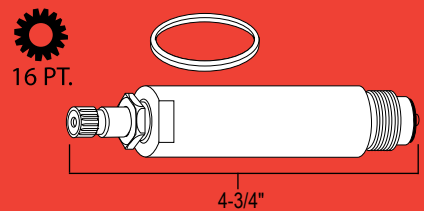

• One per bar coded display bag

28-655R Generic RH Hot Stem **22.43**
28-655L Generic LH Cold Stem **22.43**

For ELJER (RSUX5264R)

TUB & SHOWER

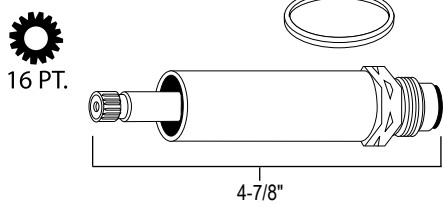

• One per bar coded display bag

28-764R Generic RH Hot Stem **21.24**
28-764L Generic LH Cold Stem **21.24**

ELKAY (A42057R) (A42058L)

LAVATORY & KITCHEN

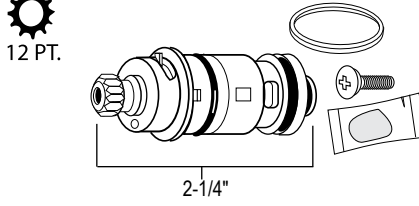

• One per bar coded display bag

26-412 Genuine RH Hot **44.50**
26-413 Genuine LH Cold **44.50**

For ELKAY (SEARS, UNIVERSAL RUNDLE) LAVATORY & KITCHEN

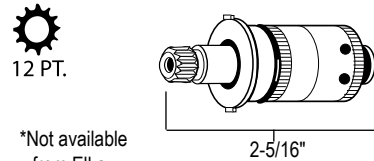

*Not available from Elkay

• One per bar coded display bag

28-375R *Generic RH Hot Stem **10.32**
28-375L *Generic LH Cold Stem **10.32**

For GERBER (98-688) (98-689)

LAVATORY & KITCHEN

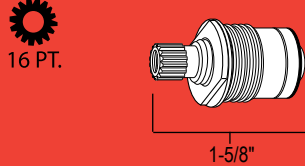

NEW STYLE

• One per bar coded display bag

28-059R Generic RH Hot Stem **3.46**
28-059L Generic LH Cold Stem **3.46**

GERBER (98-688) (98-689)

LAVATORY

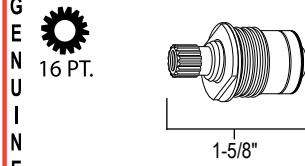

NEW STYLE

• One per bar coded display bag

28-054R Genuine RH Hot Stem **7.01**
28-054L Genuine LH Cold Stem **7.01**



available at **www.HodesCo.com**

USE YOUR CREDIT CARD AT TIME OF PURCHASE AND SAVE 2% ON ALL ORDERS, SAVE 5% ON ALL ORDERS OVER \$500 OR SAVE 10% ON ALL ORDERS OVER \$1000

FAX 1-800-982-5934 www.HODESCO.com PHONE 1-800-777-6500
280

CARTRIDGES AND STEMS (IN ALPHABETICAL ORDER AND LENGTH)



INTERNAL FAUCET REPAIR

GERBER (98-710)
(98-711)

LAVATORY & KITCHEN



16 PT.

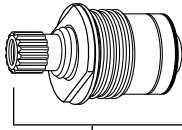

1-3/4"

- Brass bonnet
- One per bar coded display bag

WASHERLESS

26-219 Genuine LH Hot Cartridge **9.40**
26-220 Genuine RH Cold Cartridge **9.40**

GERBER (86-986)
(86-987)

LAVATORY & KITCHEN



16 PT.

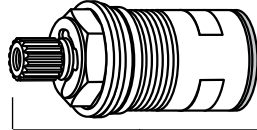

1-3/4"

- One per bar coded display bag

CERAMAFLOW

26-224 Genuine Cartridge RH Cold **23.49**
26-226 Genuine Cartridge LH Hot **23.49**

For GERBER (98-680)
(98-681)

LAVATORY & KITCHEN



16 PT.

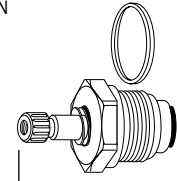

1-7/8"

- *Not available from Gerber
- One per bar coded display bag

28-160R *Generic RH Hot Stem **3.41**
28-160L *Generic LH Cold Stem **3.41**

GERBER (98-027)

LAVATORY, KITCHEN,
PRESSURE BALANCE
TUB & SHOWER

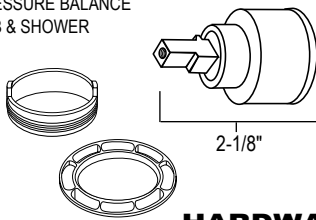

2-1/8"

- One per bar coded display bag

HARDWATER CERAMIC

26-228 Genuine Cartridge **32.96**

For GERBER/STANADYNE (97-142)
LAVATORY, KITCHEN, TUB & SHOWER

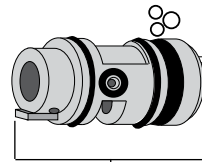

2-3/8"

- *Not available from Gerber
- For single handle faucets
- One per bar coded display bag

26-221 *Generic Cartridge **17.64**

GERBER (97-013)

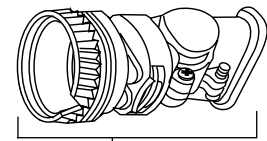

3-5/8"

HARDWATER PRESSURE BALANCE CARTRIDGE

- One per bar coded display bag

NEW

26-483 Genuine RH Hot or Cold Stem ... **85.50**



**PAY BY MAJOR CREDIT CARD
WHEN YOU PLACE YOUR ORDER
AND SAVE UP TO AN
ADDITIONAL 10%
OFF OUR ALREADY
INDUSTRY-LOW PRICES!!**

GERBER (98-705)

TUB & SHOWER



16 PT.

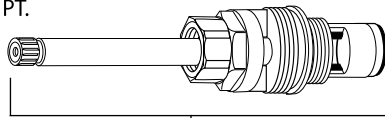

5-3/8"

- One per bar coded display bag

CERAMAFLOW

28-694R Genuine RH Hot or Cold Stem ... **35.15**

GERBER (98-726)

TUB & SHOWER



16 PT.

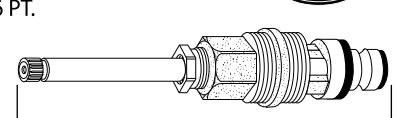

5-3/4"

- One per bar coded display bag

28-727D Genuine Diverter Stem **14.01**

28-723D Generic Diverter Stem **8.00**

For GERBER (98-673)
TUB & SHOWER



16 PT.

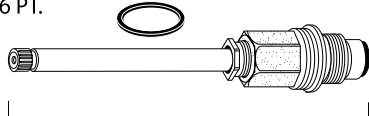

5-3/8"

- One per bar coded display bag

28-692R Generic RH Hot & Cold Stem **4.70**

For GERBER (98-673)
TUB & SHOWER



16 PT.

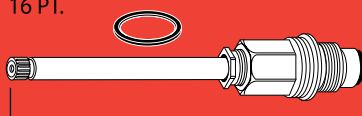

5-3/8"

- One per bar coded display bag

28-695R Generic RH Hot or Cold Stem **6.79**

GERBER (98-673)
TUB & SHOWER



16 PT.

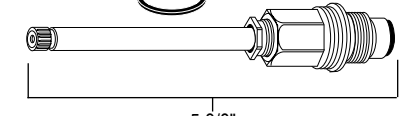

5-3/8"

- One per bar coded display bag

28-693R Genuine RH Hot or Cold Stem ... **10.56**

28-693L Genuine LH Cold Stem **13.87**

**USE YOUR CREDIT CARD AT TIME OF PURCHASE AND SAVE 2% ON ALL ORDERS,
SAVE 5% ON ALL ORDERS OVER \$500 OR SAVE 10% ON ALL ORDERS OVER \$1000**

FAX 1-800-982-5934 www. **HODES CO.** .com **PHONE 1-800-777-6500**
PROFFERED PLUMBING PRODUCTS **281**

STEMS BY MFR.

INTERNAL FAUCET REPAIR



CARTRIDGES AND STEMS
(IN ALPHABETICAL ORDER AND LENGTH)

For GLACIER BAY



NEW

- One per bar coded display bag
- 26-383** Generic Ceramic RH Hot Stem . . . **19.96**
- 26-384** Generic Ceramic LH Cold Stem . . . **19.96**

For GROHE

(45.882)
(45.883)

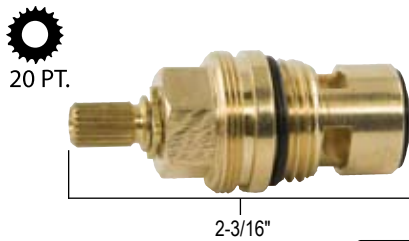

NEW

- One per bar coded display bag
- 26-397** Generic Ceramic RH Hot Stem . . . **35.70**
- 26-398** Generic Ceramic LH Cold Stem . . . **35.70**



PAY BY MAJOR CREDIT CARD WHEN YOU PLACE YOUR ORDER AND SAVE UP TO AN ADDITIONAL 10% OFF OUR ALREADY INDUSTRY-LOW PRICES!!

H&H PRECISION PRODUCTS DRINKING FOUNTAIN

(640129)

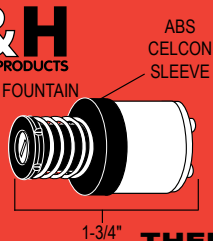

1-3/4" **THERMODISC**

- One per bar coded display bag
- 26-308** Genuine Bubblers Cartridge **61.15**
- 26-908** Generic Bubblers Cartridge **11.69**
- 24-307** Genuine Elkay (61314C) Cartridge. **22.15**

H&H PRECISION PRODUCTS DRINKING FOUNTAIN

(640128)

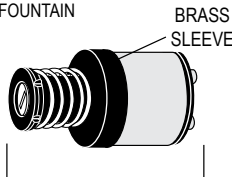

1-3/4" **THERMODISC**

- One per bar coded display bag
- 26-309** Genuine Bubblers Cartridge **62.63**

For HARCRAFT TUB & SHOWER

(3261)

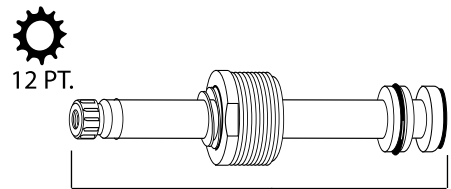

- *Not Available From Harcraft
- One per bar coded display bag
- 28-648R** *Generic RH Hot or Cold Stem . . . **10.22**

For HARDEN

(580010)
(580000)

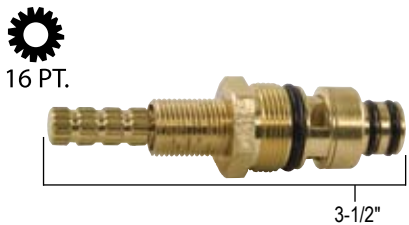

NEW

- One per bar coded display bag
- 26-369** Generic Ceramic RH Hot Stem . . . **33.31**
- 26-370** Generic Ceramic LH Cold Stem . . . **33.31**

For HARDEN

(580020)
(580030)

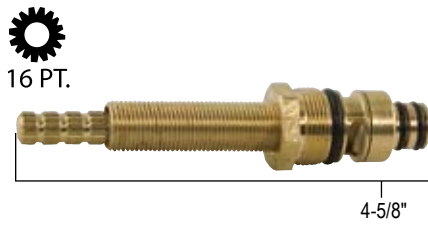

NEW

- One per bar coded display bag
- 26-379** Generic Ceramic RH Hot Stem . . . **39.61**
- 26-380** Generic Ceramic LH Cold Stem . . . **39.61**

For HARDEN

(580050)
(580060)

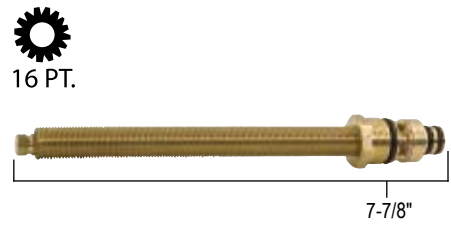

NEW

- One per bar coded display bag
- 26-399** Generic Ceramic RH Hot Stem . . . **51.51**
- 26-396** Generic Ceramic LH Cold Stem . . . **51.51**

For INDIANA BRASS LAVATORY & KITCHEN

(SA-631-C-1)
(SA-631-C-2)

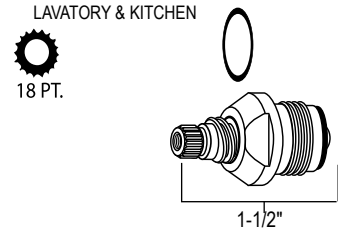

- One per bar coded display bag
- 28-015R** Generic RH Hot Stem **7.75**
- 28-015L** Generic LH Cold Stem **7.75**

For INDIANA BRASS TUB & SHOWER

(SA-552-C-2)
(SA-552-C-1)

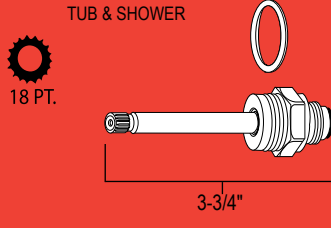

- One per bar coded display bag
- 28-580R** Generic RH Hot Stem **10.61**
- 28-580L** Generic LH Cold Stem **10.61**

For JADO

(599-150)
(599-151)

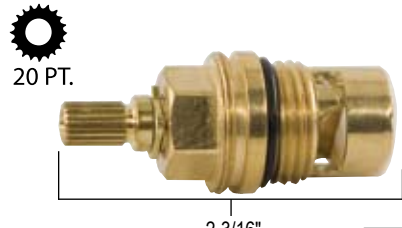

NEW

- One per bar coded display bag
- 26-345** Generic Ceramic RH Hot Stem . . . **35.70**
- 26-346** Generic Ceramic LH Cold Stem . . . **35.70**

USE YOUR CREDIT CARD AT TIME OF PURCHASE AND SAVE 2% ON ALL ORDERS, SAVE 5% ON ALL ORDERS OVER \$500 OR SAVE 10% ON ALL ORDERS OVER \$1000

CARTRIDGES AND STEMS (IN ALPHABETICAL ORDER AND LENGTH)



INTERNAL FAUCET REPAIR

For KOHLER (34253)
LAVATORY, KITCHEN, TUB & SHOWER

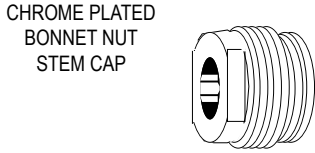

- Chrome plated brass
- One per bar coded display bag

26-500 Generic Bonnet Nut 6.79

For KOHLER (34842)
LAVATORY, KITCHEN, TUB & SHOWER

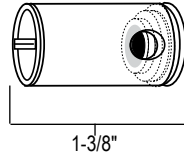

- Includes seat
- One per bar coded display bag

26-582 Generic Barrel with Seat 2.63
26-581 Genuine Barrel without Seat 6.48

For KOHLER (32462)
TUB & SHOWER

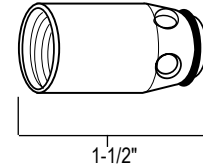

- One per bar coded display bag

26-568 Generic Hot Barrel 3.43
26-569 Generic Cold Barrel 3.43

For KOHLER (22948)
LAVATORY, KITCHEN, TUB & SHOWER

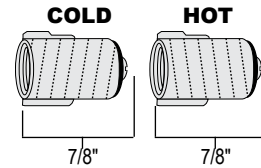

(22947)
(42300)
(42299)
(DOTTED LINES INDICATE THREAD DIRECTION)

VALVET

SOLD IN PACKAGE QTY ONLY

26-583 Generic Cold Celcon Plunger (10) . . . 1.05
26-584 Generic Hot Celcon Plunger . (10) . . 1.05
26-585 Generic Cold Brass Plunger . .(5) . . 1.67
26-586 Generic Hot Brass Plunger . .(5) . . 1.67

For KOHLER (20786)
LAVATORY, KITCHEN

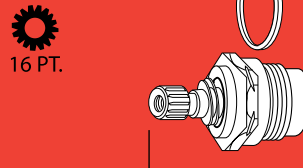

16 PT.

TREND

- One per bar coded display bag

28-014R Generic RH Hot Stem 5.38
28-014L Generic LH Cold Stem 4.68

For KOHLER (20655)
LAVATORY

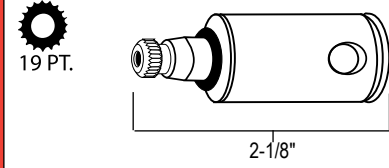

19 PT.

SHORT PATTERN

- One per bar coded display bag

28-461L Generic LH Hot Stem 7.67
28-461R Generic RH Cold Stem 7.67

KOHLER (500520)



- One per bar coded display bag

26-603 Genuine Cartridge 47.44

For KOHLER (30002)
LAVATORY, KITCHEN TUB & SHOWER

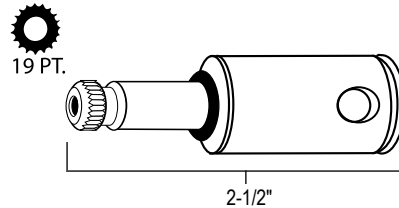

19 PT.

VALVET

- With celcon plunger
- One per bar coded display bag

28-469L Generic LH Hot Stem 5.31
28-469R Generic RH Cold Stem 5.31

KOHLER (30002)
LAVATORY, KITCHEN, TUB & SHOWER

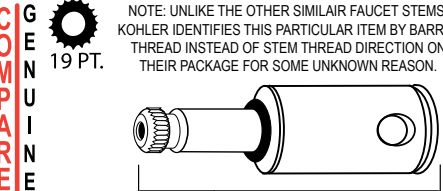

19 PT.

VALVET

NOTE: UNLIKE THE OTHER SIMILAIR FAUCET STEMS, KOHLER IDENTIFIES THIS PARTICULAR ITEM BY BARREL THREAD INSTEAD OF STEM THREAD DIRECTION ON THEIR PACKAGE FOR SOME UNKNOWN REASON.

- With celcon plunger
- One per bar coded display bag

28-479L Genuine LH Hot Stem 27.82
28-479R Genuine RH Cold Stem 27.82

For KOHLER (30002)
LAVATORY, KITCHEN, TUB & SHOWER

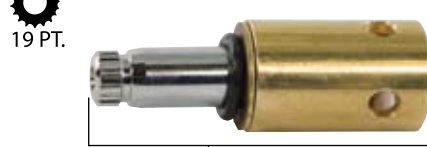

19 PT.

NEW

- One per bar coded display bag

26-353 Generic Ceramic RH Hot Stem . . . 23.59
26-354 Generic Ceramic LH Cold Stem . . 23.59

For KOHLER (30134)
LAVATORY, KITCHEN, TUB & SHOWER

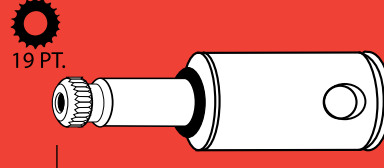

19 PT.

VALVET

- With brass plunger
- One per bar coded display bag

28-460L Generic LH Hot Stem 5.80
28-460R Generic RH Cold Stem 5.80

KOHLER (30135)
LAVATORY, KITCHEN, TUB & SHOWER

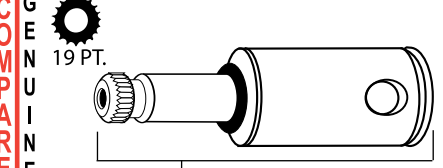

19 PT.

VALVET

- With brass plunger
- One per bar coded display bag

28-470L Genuine LH Hot Stem 27.82
28-470R Genuine RH Cold Stem 27.82

USE YOUR CREDIT CARD AT TIME OF PURCHASE AND SAVE 2% ON ALL ORDERS, SAVE 5% ON ALL ORDERS OVER \$500 OR SAVE 10% ON ALL ORDERS OVER \$1000

FAX 1-800-982-5934 www.HODES CO.com PHONE 1-800-777-6500
PROFERRED PLUMBING PRODUCTS 283

STEMS BY MFR.

INTERNAL FAUCET REPAIR



CARTRIDGES AND STEMS
(IN ALPHABETICAL ORDER AND LENGTH)

KOHLER

LAVATORY & KITCHEN

NEW # OLD #
(77005) (30430)
(77006) (30431)

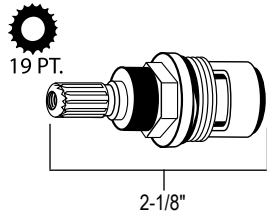

NOTE: TO CONVERT CARTRIDGE TO TURN IN OPPOSITE DIRECTION, REMOVE CLIP, PULL AND ROTATE VALVE STEM 90°, THEN REINSERT THE CLIP.

CORALAIS

- With ceramic disc
- One per bar coded display bag

26-883 Genuine Ceramic (Clockwise) Cartridge . **17.28**
26-884 Genuine Ceramic (Counterclockwise) Cartridge **17.28**

KOHLER

TUB & SHOWER

(22209)

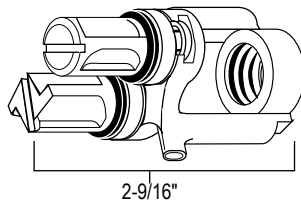

• One per bar coded display bag
26-809 Genuine Yoke **64.58**

For KOHLER

LAVATORY, KITCHEN, TUB & SHOWER

(30413)

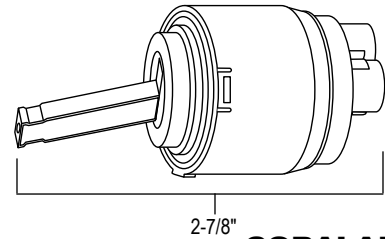

CORALAIS
26-602 Generic Cartridge **21.21**

For KOHLER

TUB & SHOWER

(20904)
(20905)

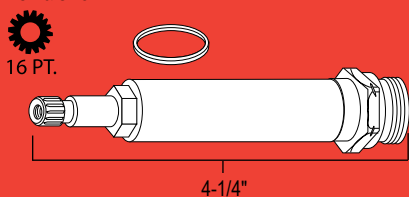

SHOREHAM TREND

• One per bar coded display bag
28-634L Generic LH Cold Stem **10.59**
28-634R Generic RH Hot Stem **10.59**

For KOHLER

TUB & SHOWER

(20868)

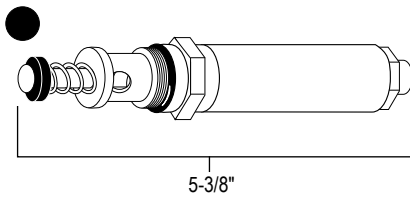

SHOREHAM TREND

• One per bar coded display bag
28-632D Generic Diverter Stem **29.99**

For KOHLER

TUB & SHOWER

(30119)

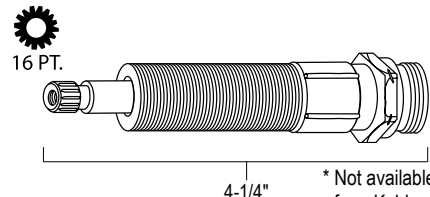

* Not available from Kohler
TREND
• One per bar coded display bag
28-633R *Generic RH Hot **15.17**
28-633L *Generic LH Cold **15.17**

For KOHLER

TUB & SHOWER

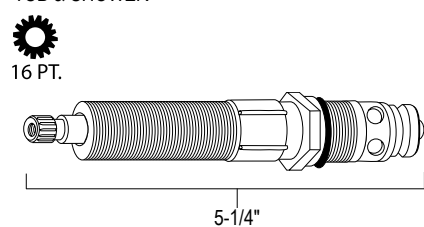

TREND

• One per bar coded display bag
28-639D Generic Diverter Stem **23.43**

For KOHLER

TUB & SHOWER

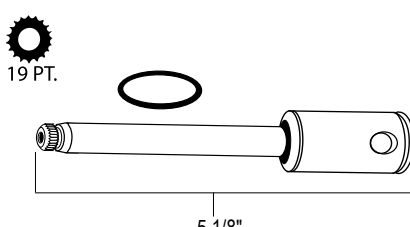

• One per bar coded display bag
28-625L Generic LH Cold Stem **19.96**

For KOHLER

TUB & SHOWER

(20242)

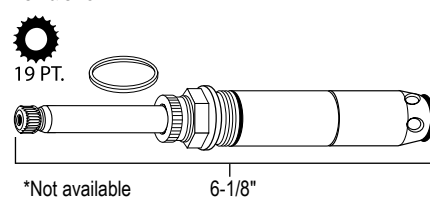

*Not available from Kohler
• One per bar coded display bag
O.S. DALNEY
28-777R *Generic RH Hot or Cold Stem . . . **23.43**

For MICHIGAN BRASS

TUB & SHOWER

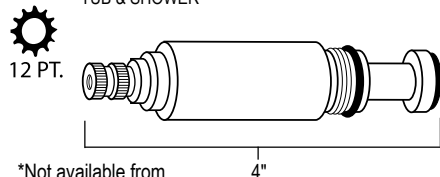

*Not available from Michigan Brass
• One per bar coded display bag
28-568R *Generic RH Cold Stem **17.05**
28-568L *Generic LH Hot Stem **17.05**

For MILWAUKEE FAUCET

TUB & SHOWER

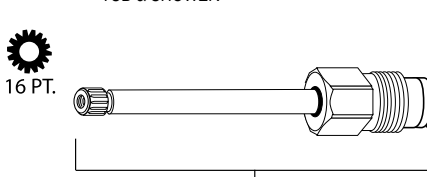

*Not available from Milwaukee Faucet
• One per bar coded display bag
28-654R *Generic RH Hot or Cold Stem . . . **19.57**

MIXET

TUB & SHOWER

(MS5AT-C)

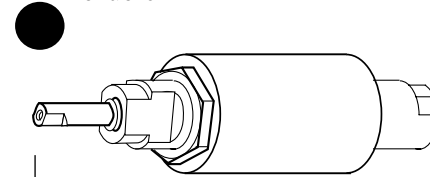

• One per bar coded display bag
26-850 Genuine Cartridge **28.05**

USE YOUR CREDIT CARD AT TIME OF PURCHASE AND SAVE 2% ON ALL ORDERS, SAVE 5% ON ALL ORDERS OVER \$500 OR SAVE 10% ON ALL ORDERS OVER \$1000

FAX 1-800-982-5934 www.HODESCO.com PHONE 1-800-777-6500
284



CARTRIDGES AND STEMS (IN ALPHABETICAL ORDER AND LENGTH)



INTERNAL FAUCET REPAIR



ROMAN TUB

(1248)



2-5/8"

- Roman Tub
- High flow roman tub replacement cartridge

26-450 Genuine Cartridge **15.22**

For MOEN
LAVATORY & KITCHEN

(1224B)

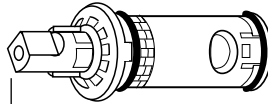

2-5/8"

For all two
handle faucets

- One per bar coded display bag

26-227 Generic Cartridge **8.23**



LAVATORY & KITCHEN

(1224B)

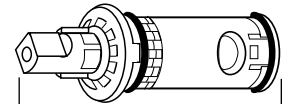

2-5/8"

For all two
handle faucets

- One per bar coded display bag

26-225 Genuine Cartridge **12.71**

GENUINE
COMPARE
GENERIC



TUB & SHOWER

(1423)

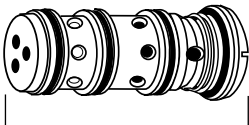

2-1/4"

- Stainless steel piston & body
- Solid brass slotted hub
- One per bar coded display bag

26-286 Genuine Balance Spool **81.94**

26-283 Generic Balance Spool **34.00**

For MOEN

LAVATORY, KITCHEN, TUB & SHOWER

(1225)

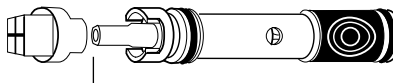

3-15/16"

For all
single control
faucets

- One per bar coded display bag

26-401 Generic Plastic Cartridge **9.40**



LAVATORY, KITCHEN, TUB & SHOWER

(1225)

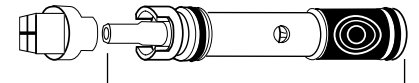

3-15/16"

For all
single control
faucets

MAGNUM

- One per bar coded display bag

26-904 Genuine Plastic Cartridge **22.16**

26-901 When Sold 12 per Case **19.93**

GENUINE
COMPARE
GENERIC



TUB & SHOWER

(1222)



For MOEN (96914)
POSI-TEMP
RETAINER CLIP
SOLD 5 PER PACKAGE ONLY
26-906 Generic **1.40**

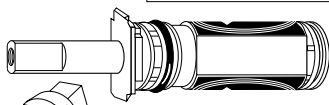

4-1/8"

POSI-TEMP

- One per bar coded display bag

26-902 Genuine Cartridge **71.40**

26-802 Generic Cartridge **29.53**

For MOEN

LAVATORY, KITCHEN, TUB & SHOWER

(1200)

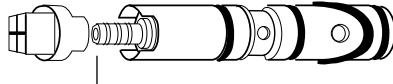

3-15/16"

For all
single control
faucets

- One per bar coded display bag

26-400 Generic Brass Cartridge **17.65**



LAVATORY, KITCHEN, TUB & SHOWER

(1200)

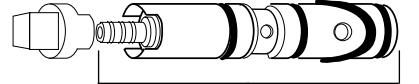

3-15/16"

- One per bar coded display bag

26-900 Genuine Brass Cartridge **25.25**

GENUINE
COMPARE
GENERIC

**USE YOUR CREDIT CARD AT TIME OF PURCHASE AND SAVE 2% ON ALL ORDERS,
SAVE 5% ON ALL ORDERS OVER \$500 OR SAVE 10% ON ALL ORDERS OVER \$1000**

FAX
1-800-982-5934

www.HODES CO.com
PROFERRED PLUMBING PRODUCTS

PHONE
1-800-777-6500
285

STEMS BY MFR.

9
8
7
6
5
4
3
2

INTERNAL FAUCET REPAIR



CARTRIDGES AND STEMS
(IN ALPHABETICAL ORDER AND LENGTH)

For NEWPORT/SANTEC

(PO458)
(PO459)

16 PT.

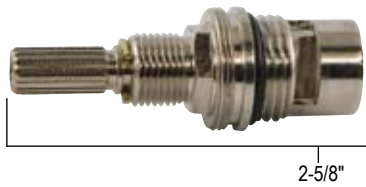

2-5/8"

NEW

• One per bar coded display bag

26-357 Generic Ceramic RH Hot Stem . . . 26.20

26-358 Generic Ceramic LH Cold Stem . . . 26.20

For NIBCO
(STREAMWAY, LIFETIME)

LAVATORY & KITCHEN

For all two handle faucets

17 PT.

Chrome plated brass broach

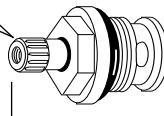

1-3/4"

*Not available from Nibco

• One per bar coded display bag

26-275 *Generic Washerless Cartridge 4.34



(85501)

LAVATORY, KITCHEN, TUB & SHOWER

17 PT.

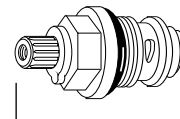

2"

• One per bar coded display bag

26-241 Genuine Hot or Cold Washerless Cartridge . 6.92

26-247 Generic Hot or Cold Washerless Cartridge . 3.53



(85549)

TUB & SHOWER

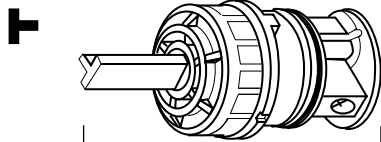

4-1/4"

• One per bar coded display bag

26-986 Genuine Cartridge 18.51

For PRICE PFISTER
LAVATORY & KITCHEN

(910-072)
(910-082)

12 PT.

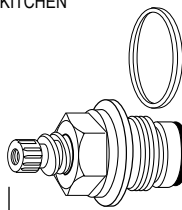

1-9/16"

28-035R Generic RH Hot Stem 5.06

28-035L Generic LH Cold Stem 5.06

PRICE PFISTER CARTRIDGE ASSEMBLY

(910-900)

12 PT.

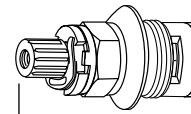

1-3/4"

C43 SERIES

• Bonnet washer included
• One per bar coded display package

26-394 Genuine Ceramic Cartridge 15.12

For PRICE PFISTER
LAVATORY & KITCHEN

12 PT.

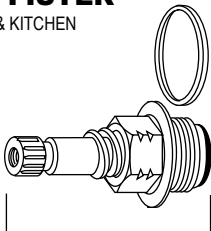

1-5/8"

• One per bar coded display bag

28-154R Generic RH Hot or Cold Stem 2.11

For PRICE PFISTER
LAVATORY & KITCHEN

(910-392)

12 PT.

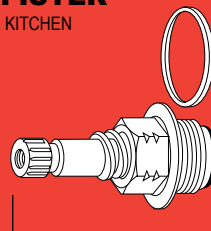

1-5/8"

• One per bar coded display bag

28-155R Generic RH Hot or Cold Stem 3.33

PRICE PFISTER
LAVATORY & KITCHEN

(910-392)

12 PT.

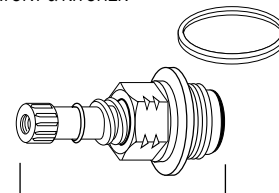

1-5/8"

• One per bar coded display bag

28-156R Genuine RH Hot or Cold Stem 4.67

PRICE PFISTER TUB & SHOWER BALANCING CARTRIDGE

(974-291)

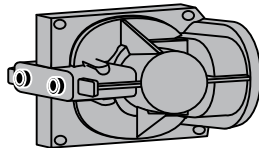

1-3/4"

NEW STYLE 08 SERIES

26-393 Genuine Balancing Cartridge 20.45

PRICE PFISTER BALANCING CARTRIDGE ASSEMBLY

(974-491)

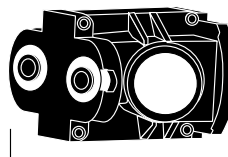

1-3/4"

OLD STYLE 08 SERIES BODYGUARD

• One per bar coded display package

26-391 Genuine Cartridge 40.51

PRICE PFISTER COMPLETE VALVE STEM ASSEMBLY

(971-250)



2-1/2"

• One per bar coded display package

26-390 Genuine Cartridge 26.47

USE YOUR CREDIT CARD AT TIME OF PURCHASE AND SAVE 2% ON ALL ORDERS, SAVE 5% ON ALL ORDERS OVER \$500 OR SAVE 10% ON ALL ORDERS OVER \$1000

FAX 1-800-982-5934

www.HODESCO.com

PHONE 1-800-777-6500

STEMS BY MFR.

CARTRIDGES AND STEMS (IN ALPHABETICAL ORDER AND LENGTH)



INTERNAL FAUCET REPAIR



PRICE PFISTER

LAVATORY & KITCHEN

(910-682)
(910-692)



12 PT.

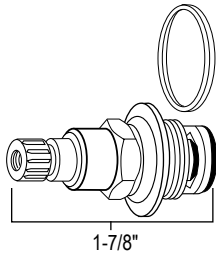

1-7/8"

- One per bar coded display bag

HYDROSEAL

28-231R Genuine RH Hot Cartridge **9.42**
28-231L Genuine LH Cold Cartridge **9.42**

For PRICE PFISTER

LAVATORY & KITCHEN

(910-282)
(910-292)



12 PT.

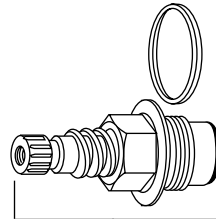

1-7/8"

- One per bar coded display bag

28-185R Generic RH Hot Stem **2.35**
28-185L Generic LH Cold Stem **2.35**

For PRICE PFISTER

LAVATORY & KITCHEN

(910-681)
(910-691)



12 PT.

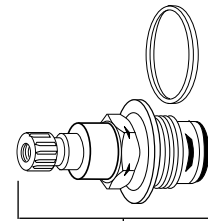

1-15/16"

- One per bar coded display bag

26-288R Generic RH Cold Stem **7.01**
26-288L Generic LH Hot Stem **7.01**



PRICE PFISTER

TUB & SHOWER & LAVATORY & KITCHEN

(974-570)

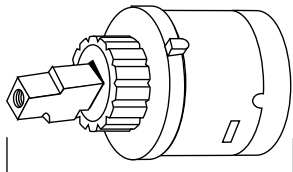

2-1/2"

- Ceramic single control

26-234 Genuine Cartridge **33.19**



PRICE PFISTER

TUB & SHOWER

(900-022)

NOTE: ALTHOUGH PRICE PFISTER ONLY INCLUDES FOUR SCREWS, OUR 20-243 SCREW WILL FIT IF MORE ARE NEEDED.

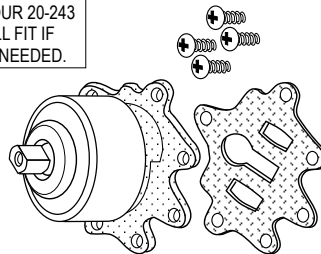

- One per bar coded display bag

26-237 Genuine Cartridge Kit **97.59**

For PRICE PFISTER

LAVATORY & KITCHEN



12 PT.

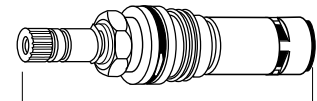

3-1/4"

WASHERLESS

- One per bar coded display bag

28-392R Generic RH Hot Stem **13.73**
28-392L Generic LH Cold Stem **13.73**

For PRICE PFISTER

LAVATORY, KITCHEN, TUB & SHOWER

(974-292)

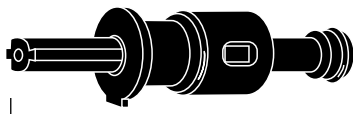

4"

- For single control kitchen, lavatory and tub and shower faucets
- One per bar coded display bag

AVANTE

26-229 Generic Cartridge **11.10**



PRICE PFISTER

LAVATORY, KITCHEN, TUB & SHOWER

(974-292)



4"

- For single control kitchen, lavatory and tub and shower faucets
- One per bar coded display bag

AVANTE

26-230 Genuine Cartridge **19.94**



PRICE PFISTER

CERAMIC CARTRIDGE

(910-030)



12 PT.

TUB AND SHOWER

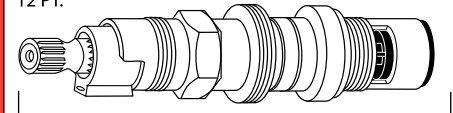

4-1/2"

VERVE & WINDSOR

- Washer included
- One per bar coded display package

26-392 Genuine Ceramic Cartridge **32.28**
26-992 Generic Ceramic Cartridge **22.32**

USE YOUR CREDIT CARD AT TIME OF PURCHASE AND SAVE 2% ON ALL ORDERS, SAVE 5% ON ALL ORDERS OVER \$500 OR SAVE 10% ON ALL ORDERS OVER \$1000

FAX 1-800-982-5934

www.HODES CO.com



PHONE 1-800-777-6500

INTERNAL FAUCET REPAIR



CARTRIDGES AND STEMS
(IN ALPHABETICAL ORDER AND LENGTH)

For PRICE PFISTER

(910-013)

TUB & SHOWER



12 PT.

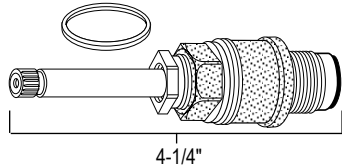

4-1/4"

• One per bar coded display bag

28-656R Generic RH Hot or Cold Stem 9.42



PRICE PFISTER

(910-022)

TUB & SHOWER



12 PT.

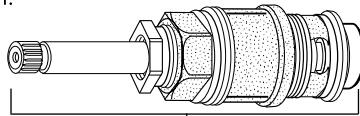

4-1/4"

• One per bar coded display bag

28-675D Genuine Diverter Stem 15.19

For PRICE PFISTER

(910-043)

TUB & SHOWER



12 PT.

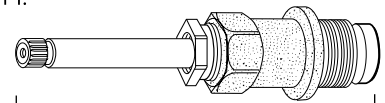

5-1/8"

• One per bar coded display bag

28-684R Generic RH Hot or Cold Stem 11.56

For PRICE PFISTER

WIDESPREAD LAVATORY



12 PT.

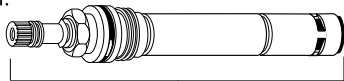

5"

WASHERLESS

• One per bar coded display bag

28-494R Generic RH Hot or Cold Stem 18.31



For PRICE PFISTER

WIDESPREAD LAVATORY



12 PT.

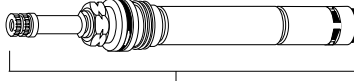

5-1/2"

WASHERLESS

• One per bar coded display bag

28-561R Generic RH Hot Stem 19.44

28-561L Generic LH Cold Stem 19.44



For PRICE PFISTER

TUB & SHOWER



12 PT.

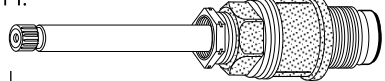

5-1/2"

• One per bar coded display bag

28-665R Generic RH Hot or Cold Stem 11.77

For PRICE PFISTER

TUB & SHOWER



12 PT.

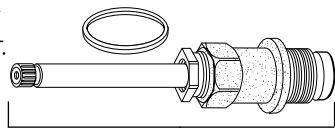

5-1/2"

VERVE, WINDSOR

• One per bar coded display bag

28-659R Generic RH Hot or Cold Stem 5.83

For PRICE PFISTER

TUB & SHOWER



12 PT.

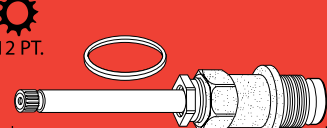

5-1/2"

VERVE,

• One per bar coded display bag

28-660R Generic RH Hot or Cold Stem 10.30



PRICE PFISTER

TUB & SHOWER



12 PT.

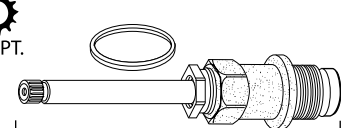

5-1/2"

VERVE, WINDSOR

• One per bar coded display bag

28-661R Genuine RH Hot or Cold Stem 13.78

For PRICE PFISTER

WIDESPREAD LAVATORY, TUB & SHOWER



12 PT.

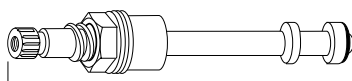

4-3/4"

*No Longer Available From Price Pfister

• One per bar coded display box

28-736R *Generic RH Hot or Cold Stem 16.71



For PRICE PFISTER

TUB & SHOWER



12 PT.

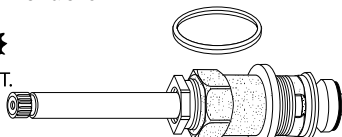

5-1/2"

VERVE, WINDSOR

• One per bar coded display bag

28-823D Generic Diverter Stem 11.48



PRICE PFISTER

TUB & SHOWER



12 PT.

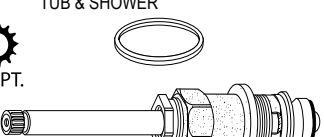

5-1/2"

VERVE, WINDSOR

• One per bar coded display bag

28-824D Genuine Diverter Stem 15.30

DOMESTIC IMPORTED

GENUINE COMPARE

USE YOUR CREDIT CARD AT TIME OF PURCHASE AND SAVE 2% ON ALL ORDERS, SAVE 5% ON ALL ORDERS OVER \$500 OR SAVE 10% ON ALL ORDERS OVER \$1000

FAX 1-800-982-5934 www.HODES CO.com PHONE 1-800-777-6500
288



CARTRIDGES AND STEMS (IN ALPHABETICAL ORDER AND LENGTH)



INTERNAL FAUCET REPAIR



LAVATORY, KITCHEN, TUB & SHOWER

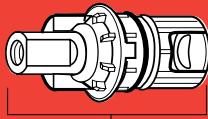

- Stainless steel bottom
- 1 per bar coded display package
- For two handle faucets
- One per bar coded display bag

26-637 Genuine Hot or Cold Cartridge 2.35



TUB & SHOWER

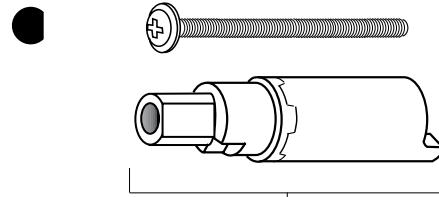

- Includes screw
- One per bar coded display bag

26-647 Genuine Extender 2.92

For SAYCO (K4500)
LAVATORY & KITCHEN

16 PT.

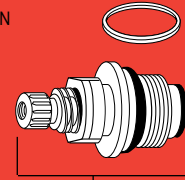

- One per bar coded display bag

28-020R Generic RH Hot Stem 5.45
28-020L Generic LH Cold Stem 5.45

For SAYCO

TUB & SHOWER

16 PT.

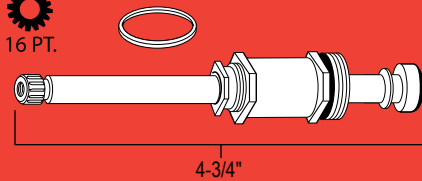

- One per bar coded display bag

28-637R Generic RH Hot Stem 6.98
28-637L Generic LH Cold Stem 6.98

For SAYCO

TUB & SHOWER

16 PT.

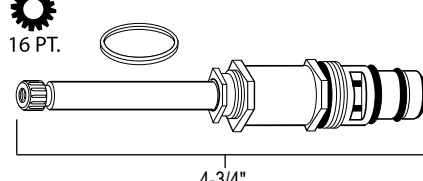

NEW STYLE

- One per bar coded display bag

28-738D Generic Diverter Stem 11.78

For SAYCO

TUB & SHOWER

16 PT.

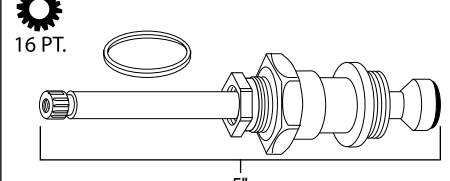

- One per bar coded display bag

28-670R Generic RH Hot or Cold Stem 15.23

For SPEAKMAN

(G05-0532)
(G05-0533)

20 PT.



- One per bar coded display bag

26-295 Generic Ceramic Cartridge 28.40
26-296 Generic Ceramic Cartridge 28.40



**PAY BY MAJOR CREDIT CARD
WHEN YOU PLACE YOUR ORDER
AND SAVE UP TO AN
ADDITIONAL 10%
OFF OUR ALREADY
INDUSTRY-LOW PRICES!!**

For SPEAKMAN

(G05-0688)
(G05-0689)

20 PT.



- One per bar coded display bag

26-367 Generic Ceramic Cartridge 30.91
26-368 Generic Ceramic Cartridge 30.91

HODESCO
PROFERRED PLUMBING PRODUCTS

Case Lot Pricing
available at
www.HodesCo.com

For STERLING
LAVATORY & KITCHEN

(A8153)
(A8154)

16 PT.

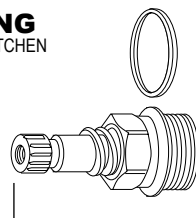

- One per bar coded display bag

28-205R Generic RH Hot Stem 5.14
28-205L Generic LH Cold Stem 5.14

For STERLING
KITCHEN

(05050)

16 PT.

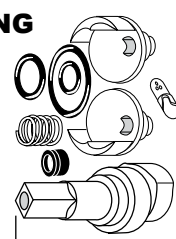

- One per bar coded display bag

26-239 Generic Cartridge Kit 5.11

**USE YOUR CREDIT CARD AT TIME OF PURCHASE AND SAVE 2% ON ALL ORDERS,
SAVE 5% ON ALL ORDERS OVER \$500 OR SAVE 10% ON ALL ORDERS OVER \$1000**

FAX 1-800-982-5934 www.HODESCO.com PHONE 1-800-777-6500
289

STEMS BY MFR.

INTERNAL FAUCET REPAIR



CARTRIDGES AND STEMS
(IN ALPHABETICAL ORDER AND LENGTH)

STERLING (00A1414)

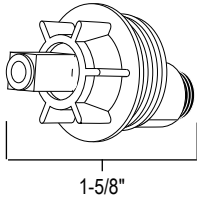

• One per bar coded display bag

26-191 Genuine Cartridge Kit 6.85

For STERLING (00A5023)
KITCHEN

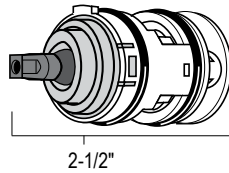

• One per bar coded display bag

26-935 Generic Cartridge 15.30

STERLING (05200)
TUB & SHOWER

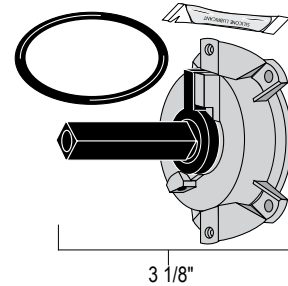

• One per bar coded display bag

26-200 Genuine Cartridge 22.04

For STERLING (05030)
TUB & SHOWER

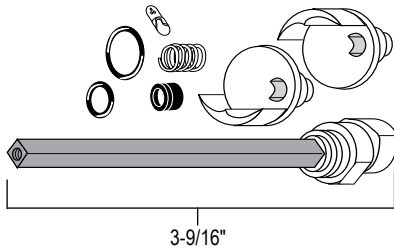

• One per bar coded display bag

26-243 Generic Cartridge Kit 9.42

For STERLING (A8105)
TUB & SHOWER



16 PT.

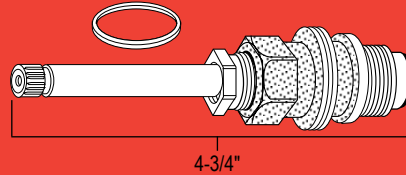

• One per bar coded display bag

28-645R Generic RH Hot or Cold Stem . . 10.05

For STERLING (A8106)
TUB & SHOWER



16 PT.

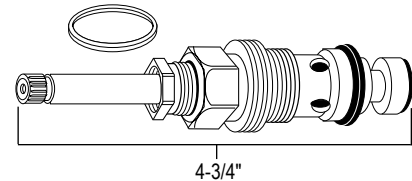

*NOT AVAILABLE FROM STERLING

• One per bar coded display bag

28-650D *Generic Diverter Stem 14.00

STERLING (00A2361)
TUB & SHOWER



16 PT.

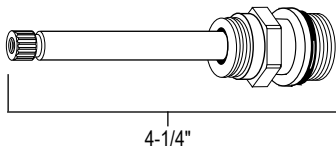

• One per bar coded display bag

28-489R Genuine RH Hot or Cold Stem . . 14.76

For STERLING (99S8005)
TUB & SHOWER



16 PT.

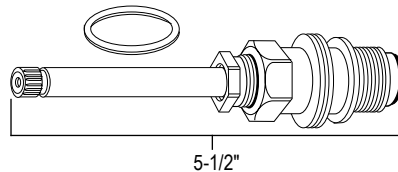

*NOT AVAILABLE FROM STERLING

• One per bar coded display bag

28-715R *Generic RH Hot or Cold Stem . . 11.67

For STERLING (9957-25)
TUB & SHOWER



16 PT.

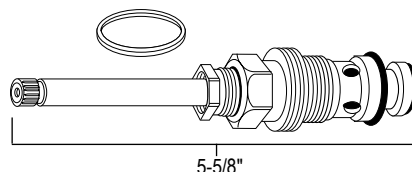

*NOT AVAILABLE FROM STERLING

• One per bar coded display bag

28-731D *Generic Diverter Stem 16.66

USE YOUR CREDIT CARD AT TIME OF PURCHASE AND SAVE 2% ON ALL ORDERS, SAVE 5% ON ALL ORDERS OVER \$500 OR SAVE 10% ON ALL ORDERS OVER \$1000

FAX 1-800-982-5934 www.HODESCO.com PHONE 1-800-777-6500
290



STEMS BY MFR.

9
8
7
6
5
4
3
2

CARTRIDGES AND STEMS (IN ALPHABETICAL ORDER AND LENGTH)



INTERNAL FAUCET REPAIR

For STREAMWAY (NIBCO) (85501)
LAVATORY, KITCHEN



17 PT.

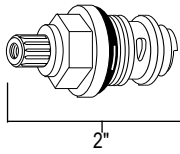

• One per bar coded display bag

26-247 Generic Hot or Cold Washerless Cartridge **3.53**

For STREAMWAY (1806)
LAVATORY & KITCHEN



17 PT.

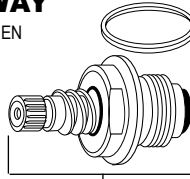

*NOT AVAILABLE FROM STREAMWAY

• One per bar coded display bag

18 THREADS PER INCH

28-110R *Generic RH Hot Stem **5.37**

28-110L *Generic LH Cold Stem **5.37**

For STREAMWAY (1805)
LAVATORY & KITCHEN



17 PT.

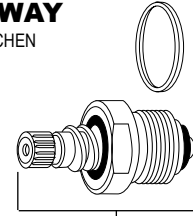

*NOT AVAILABLE FROM STREAMWAY

• One per bar coded display bag

28-115R *Generic RH Hot Stem **5.80**

For STREAMWAY



17 PT.

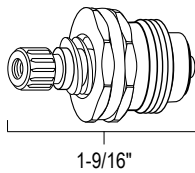

*NOT AVAILABLE FROM STREAMWAY

28-108R *Generic RH Hot or Cold Stem **5.59**

For SYMMONS (TA-4)

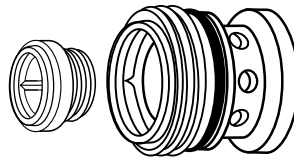

TEMPROL

• One per bar coded display bag

22-467 Generic 2 Pc. Repair Kit **14.00**

22-967 Genuine 2 Pc. Repair Kit **47.84**

Symmons (SC-3)

RENEWABLE SEAT ASSEMBLY

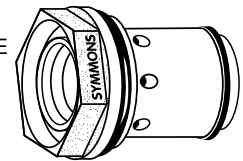

SAFETYMIX

• One per bar coded display bag

21-175 Genuine 3 Pc. Repair Kit **49.90**

Symmons (TA-10)
TUB & SHOWER



12 PT.

3/8" BROACH

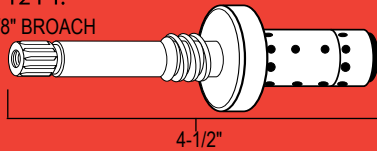

26-969 Genuine Spindle **73.55**

Symmons (C-5)
TUB & SHOWER



12 PT.

1/2" BROACH

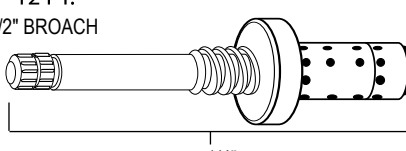

26-176 Genuine Spindle **93.99**

**ASK ABOUT
OUR STOCK
SERVICE
SYSTEM™
FEATURING
BARCODE
SCANNING
INVENTORY**

For T & S (788-20) (64L)
(789-20) (66L)

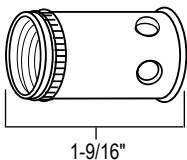

27-485 Generic Hot Barrel **6.56**

27-507 Generic Cold Barrel **6.56**

T&S (788-20) (64L)
(789-20) (66L)

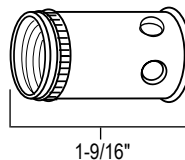

27-491 Genuine Hot Barrel **10.40**

27-492 Genuine Cold Barrel **10.40**

GENUINE COMPARE

• One per bar coded display bag



**PAY BY MAJOR CREDIT CARD
WHEN YOU PLACE YOUR ORDER
AND SAVE UP TO AN
ADDITIONAL 10%
OFF OUR ALREADY
INDUSTRY-LOW PRICES!!**

**USE YOUR CREDIT CARD AT TIME OF PURCHASE AND SAVE 2% ON ALL ORDERS,
SAVE 5% ON ALL ORDERS OVER \$500 OR SAVE 10% ON ALL ORDERS OVER \$1000**

FAX 1-800-982-5934 www.HODESCO.com PHONE 1-800-777-6500
PROFFERED PLUMBING PRODUCTS 291

STEMS BY MFR.

INTERNAL FAUCET REPAIR



CARTRIDGES AND STEMS
(IN ALPHABETICAL ORDER AND LENGTH)

9
8
7
6
5
4
3
2
STEMS BY MFR.



CERAMIC CARTRIDGE WITH BONNET

(078A)
(079A)

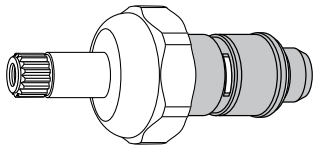

- 28-914R Genuine Ceramic RH Cold **50.02**
- 28-914L Genuine Ceramic LH Hot **50.02**

For
T & S

(011276-45)
(011277-45)

CERAMIC CARTRIDGE



20 PT.



3"

NEW

- 26-375 Generic Ceramic RH Cold **31.71**
- 26-476 Generic Ceramic LH Hot **31.71**



(002856-40)

BONNET ASSEMBLY

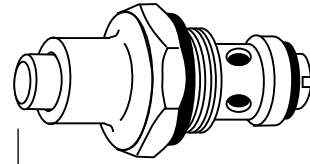

2-1/4"

- 10-370 Genuine Complete Bonnet Assembly . **35.43**
- 18-117 Generic Complete Bonnet Assembly . **22.19**



(811-25)
(812-25)

LAVATORY & KITCHEN



20 PT.

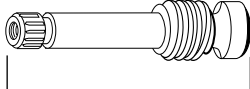

2-5/8"

• One per bar coded display bag

- 28-286R Genuine RH Hot Stem **10.53**
- 28-286L Genuine LH Cold Stem **10.53**

For
T & S

(6478-40)
(6477-40)

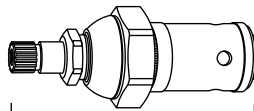

3"

• One per bar coded display bag

- 28-126R Genuine RH Hot Stem **36.77**
- 28-126L Genuine LH Cold Stem **36.77**

For
UNION BRASS

(1837AH)
(1837AC)

LAVATORY & KITCHEN



18 PT.

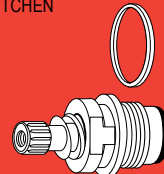

1-1/2"

- 28-025R Generic RH Hot Stem **2.87**
- 28-025L Generic LH Cold Stem **2.87**



(1839A-H)
(1839A-C)

LAVATORY & KITCHEN



18 PT.

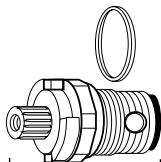

1-1/2"

- 26-248 Genuine Hot or Cold Cartridge **18.88**
- 26-249 Genuine Cold Cartridge **18.88**

For
UNION BRASS

(1840)

TUB & SHOWER



18 PT.

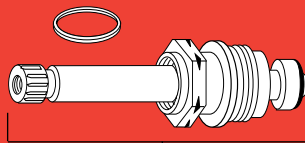

3-3/8"

- 28-550R Generic RH Hot Stem **8.16**
- 28-550L Generic LH Cold Stem **8.16**



(1844A-H)

TUB & SHOWER



18 PT.

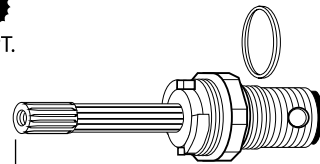

3-3/8"

- 26-251 Genuine Hot or Cold Cartridge **25.81**

For
UNION BRASS

(3410)

TUB & SHOWER

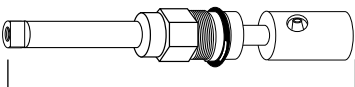

4-5/8"

- 28-553D Generic Diverter Stem **23.28**

For
UNIVERSAL RUNDLE



20 PT.



2-1/8"

NEW

• One per bar coded display bag

- 26-373 Generic Ceramic RH Hot Stem . . . **19.09**
- 26-374 Generic Ceramic LH Cold Stem . . . **19.09**

For
UNIVERSAL RUNDLE (ELKAY/SEARS)

LAVATORY & KITCHEN



12 PT.

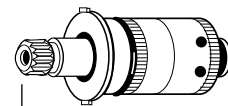

2-5/16"

*NOT AVAILABLE FROM ELKAY

- 28-375R *Generic RH Hot Stem **10.32**
- 28-375L *Generic LH Cold Stem **10.32**

USE YOUR CREDIT CARD AT TIME OF PURCHASE AND SAVE 2% ON ALL ORDERS, SAVE 5% ON ALL ORDERS OVER \$500 OR SAVE 10% ON ALL ORDERS OVER \$1000

FAX
1-800-982-5934
292

www. **HODES CO.** .com
PREFERRED PLUMBING PRODUCTS

PHONE
1-800-777-6500

CARTRIDGES AND STEMS (IN ALPHABETICAL ORDER AND LENGTH)



INTERNAL FAUCET REPAIR

For UNIVERSAL RUNDLE (MILWAUKEE/SEARS)

(P9354)

LAVATORY & KITCHEN

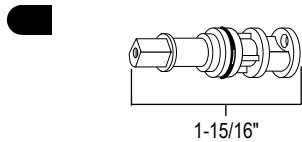

* NOT AVAILABLE FROM UNIVERSAL RUNDLE
• One per bar coded display bag

26-271 *Generic Cartridge **5.85**

For VALLEY LAVATORY & KITCHEN

(V6804)

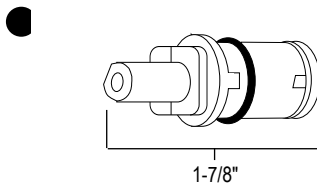

For 2 handle faucets
• One per bar coded display bag

26-552 Generic Cartridge **3.53**

Valley LAVATORY & KITCHEN

(V6804)

GENUINE COMPARE ERIC

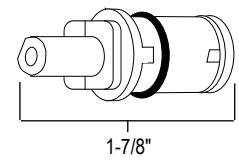

For 2 handle faucets
• One per bar coded display bag

26-452 Genuine Cartridge **5.85**

For UNIVERSAL RUNDLE/MILWAUKEE/SEARS

LAVATORY & KITCHEN

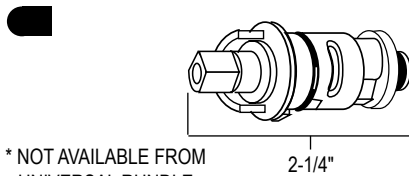

* NOT AVAILABLE FROM UNIVERSAL RUNDLE
• One per bar coded display bag

26-252 *Generic RH Hot (Red) **7.08**
26-253 *Generic LH Cold (Blue) **7.08**

For VALLEY LAVATORY, KITCHEN, TUB & SHOWER

(V6680)

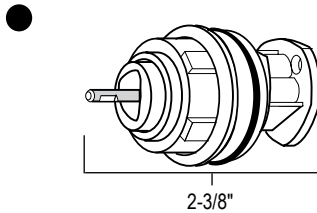

For single handle faucets
• One per bar coded display bag

26-926 Generic Cartridge **4.57**

Valley LAVATORY, KITCHEN, TUB & SHOWER

(V6680)

GENUINE COMPARE ERIC

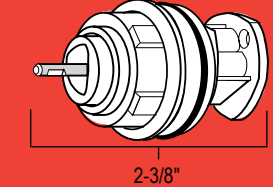

• For single handle faucets
• One per bar coded display bag

26-925 Genuine Cartridge **6.91**

For UNIVERSAL RUNDLE (MILWAUKEE/SEARS)

LAVATORY, KITCHEN, TUB & SHOWER

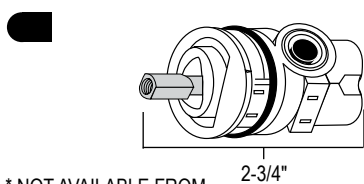

* NOT AVAILABLE FROM UNIVERSAL RUNDLE
• One per bar coded display bag

26-264 *Generic Cartridge **10.59**

For VALLEY KITCHEN, TUB & SHOWER

(VP1964)

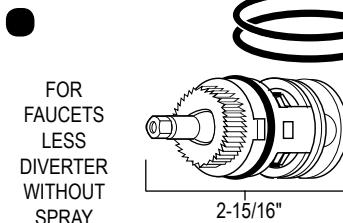

FOR FAUCETS LESS DIVERTER WITHOUT SPRAY

• One per bar coded display bag

26-885 Generic Cartridge **11.72**

Valley KITCHEN, TUB & SHOWER

(VP1964)

GENUINE COMPARE ERIC

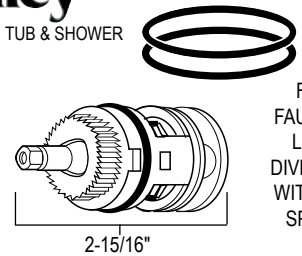

FOR FAUCETS LESS DIVERTER WITHOUT SPRAY

• One per bar coded display bag

26-985 Genuine Cartridge **17.66**

For VALLEY KITCHEN

(VP1965)

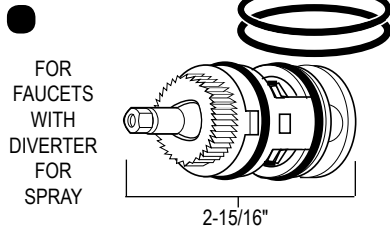

FOR FAUCETS WITH DIVERTER FOR SPRAY

• One per bar coded display bag

26-887 Generic Cartridge **14.09**

Valley KITCHEN

(VP1965)

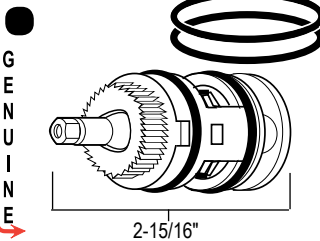

FOR FAUCETS WITH DIVERTER FOR SPRAY

• One per bar coded display bag

26-984 Genuine Cartridge **25.84**

For VALLEY TUB & SHOWER

(V4268)



• One per bar coded display bag

26-921 *Generic Cartridge **39.87**

USE YOUR CREDIT CARD AT TIME OF PURCHASE AND SAVE 2% ON ALL ORDERS, SAVE 5% ON ALL ORDERS OVER \$500 OR SAVE 10% ON ALL ORDERS OVER \$1000

FAX 1-800-982-5934 www.HODES CO.com PHONE 1-800-777-6500
PROFFERED PLUMBING PRODUCTS 293

STEMS BY MFR.

INTERNAL FAUCET REPAIR



FAUCET REPAIR KITS
(PACKAGED IN ZIP-LOCK DISPLAY BAGS)

For AMERICAN KITCHEN (H-101)
(C-101)
KITCHEN

LF 210

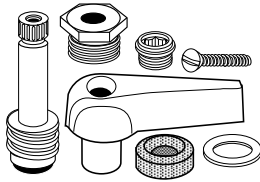

*NOT AVAILABLE FROM AMERICAN KITCHEN

23-112H *Generic 7 Pc. Repair Kit (Hot) . . . **19.93**
23-112C *Generic 7 Pc. Repair Kit (Cold) . . **19.93**

For AMERICAN KITCHEN (H-104)
(C-104)
KITCHEN

LF 110

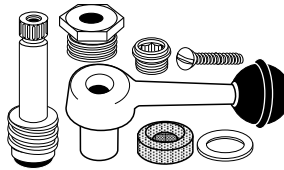

*NOT AVAILABLE FROM AMERICAN KITCHEN

23-105H *Generic Repair Kit (Hot) **23.48**
23-105C *Generic Repair Kit (Cold) **23.48**

For AMERICAN STANDARD (72495-07)
LAVATORY, KITCHEN, TUB & SHOWER

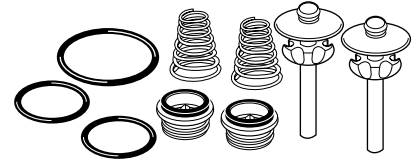

*NOT AVAILABLE FROM AMERICAN STANDARD

OLD STYLE

22-805 *Generic 10 Pc. Repair Kit **11.65**

For AMERICAN STANDARD
LAVATORY, KITCHEN, TUB & SHOWER



AQUASEAL

21-172 Generic 7 Pc. Repair Kit **3.36**

For AMERICAN STANDARD (57583-07)
LAVATORY & KITCHEN

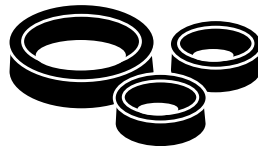

SET OF THREE SEALS FOR AQUARIAN CARTRIDGES

*NOT AVAILABLE FROM AMERICAN STANDARD

AQUARIAN

21-840 *Generic 3 Pc. Repair Kit **1.47**

For AMERICAN STANDARD
LAVATORY, KITCHEN, TUB & SHOWER



*NOT AVAILABLE FROM AMERICAN STANDARD

AQUASEAL

21-607 *Generic 5 Pc. Repair Kit **.88¢**

For AMERICAN STANDARD (72940-07)
LAVATORY, KITCHEN, TUB & SHOWER



AQUASEAL

SOLD 10 PER PACKAGE ONLY

26-170 Generic Diaphragm **.65¢**

For AMERICAN STANDARD
TUB & SHOWER

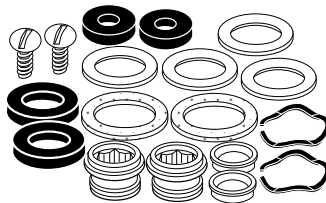

*NOT AVAILABLE FROM AMERICAN STANDARD

COLONY

22-856 *Generic 18 Pc. Repair Kit **5.85**

For AMERICAN STANDARD (44293-007)
LAVATORY, KITCHEN, TUB & SHOWER



CADET

SOLD 10 PER PACKAGE ONLY

20-181 Generic Diaphragm **.35¢**

Bradley CORPORATION (S65-074)



* For 90-75 faucet

45-162 Genuine Repair Kit **125.72**

Bradley CORPORATION (S65-070)
SHOWER

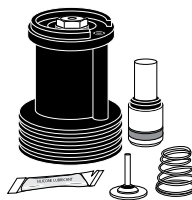

TOUCH 'N FLOW

45-143 Genuine 5 Pc Shower Valve Repair Kit . **128.79**

Bradley CORPORATION (S01-116)

VERNATHERM ASSEMBLY

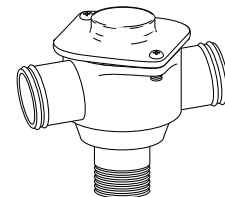

45-202 Genuine Vernatherm Assembly . . **446.36**

REPAIR KITS

USE YOUR CREDIT CARD AT TIME OF PURCHASE AND SAVE 2% ON ALL ORDERS, SAVE 5% ON ALL ORDERS OVER \$500 OR SAVE 10% ON ALL ORDERS OVER \$1000

FAX 1-800-982-5934 www.HODESCO.com PHONE 1-800-777-6500
294 **HODESCO** PREFERRED PLUMBING PRODUCTS

FAUCET REPAIR KITS

(PACKAGED IN ZIP-LOCK DISPLAY BAGS)



INTERNAL FAUCET REPAIR



(671-XJKNF)

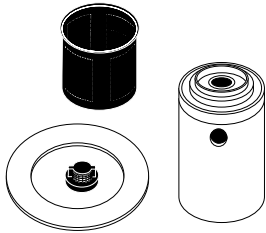

21-084 Genuine Metering Valve Unit **43.46**



(665-190-KJK)

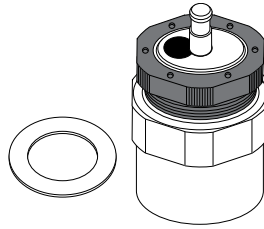

• For MVP
21-086 Genuine Actuator assembly **24.19**



(667-080 KJK)

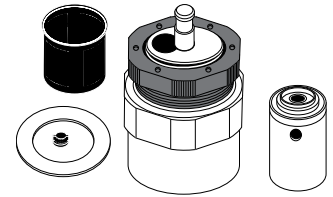

• Repairs MVP Metering Valve
• Contains one each of kit 671x and 665-190K
21-085 Genuine Chicago Faucet Repair Kit **59.89**



(849)

LAVATORY



NAIAD

21-114 Genuine 17 Pc. Repair Kit **17.69**



(892032)
(892-202KD)

VACUUM BREAKER KITS

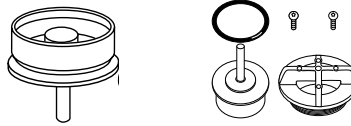

49-510

49-511

• For repairs on 1/2" & 3/4"
VACUUM BREAKERS
49-510 Genuine Repair Kit **14.11**
49-511 Genuine 5 Pc. Repair Kit **19.76**



(277)

LAVATORY, KITCHEN, TUB & SHOWER

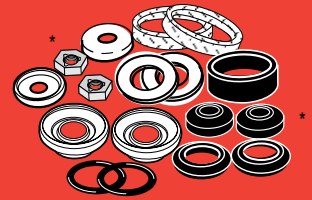

*No Longer Available
From Chicago Faucet

QUATURN

21-112 Genuine 17 Pc. Repair Kit **15.19**



(1277D)

LAVATORY, KITCHEN, TUB & SHOWER

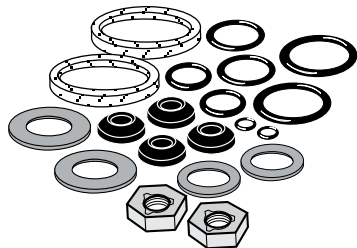

21-115 Genuine 22 Pc. Repair Kit **16.43**

For CRANE

LAVATORY, KITCHEN, TUB & SHOWER

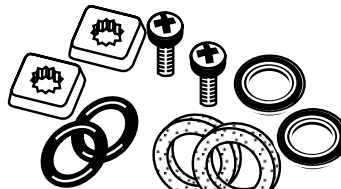

*Not Available
From Crane

DIALEZE

21-126 *Generic 10 Pc. Repair Kit **2.35**

For CRANE

LAVATORY, KITCHEN, TUB & SHOWER



*Not Available
From Crane

DIALEZE

21-122 *Generic 8 Pc. Repair Kit **1.76**



GENUINE PARTS
LAVATORY, KITCHEN,
TUB & SHOWER



• 289 piece jumbo master repair kit to repair all models
• Illustration chart in lid

21-137 Genuine Delta Master Faucet Assortment. **618.42**



GENUINE PARTS
LAVATORY, KITCHEN, TUB & SHOWER

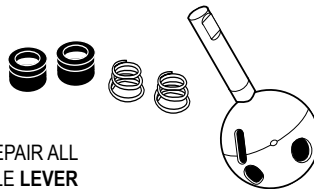

TO REPAIR ALL
SINGLE LEVER
FAUCETS

23-407 Genuine 5 Pc. Repair Kit **5.18**



GENUINE PARTS
LAVATORY, KITCHEN, TUB & SHOWER

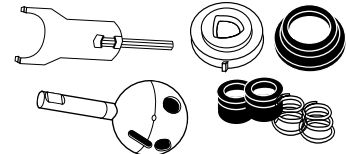

TO REPAIR ALL
SINGLE LEVER FAUCETS

23-404 Genuine 8 Pc. Repair Kit **8.81**

**USE YOUR CREDIT CARD AT TIME OF PURCHASE AND SAVE 2% ON ALL ORDERS,
SAVE 5% ON ALL ORDERS OVER \$500 OR SAVE 10% ON ALL ORDERS OVER \$1000**

FAX
1-800-982-5934

www.HODESCO.com
PROFFERED PLUMBING PRODUCTS

PHONE
1-800-777-6500
295

REPAIR KITS

INTERNAL FAUCET REPAIR



GENUINE DELTA REPAIR KITS
(PACKAGED IN ZIP-LOCK DISPLAY BAGS)

DELTA
FAUCET COMPANY
GENUINE PARTS
LAVATORY, KITCHEN, TUB & SHOWER

(RP4993)



SEATS & SPRINGS
TO REPAIR
ALL MODELS

NEW STYLE

23-400 Genuine 4 Pc. Repair Kit **1.76**

DELTA
FAUCET COMPANY
GENUINE PARTS
LAVATORY, KITCHEN, TUB & SHOWER

(RP188)

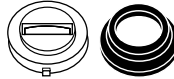

TO REPAIR ALL
SINGLE KNOB
FAUCETS

23-405 Genuine 2 Pc. Repair Kit **2.28**

DELTA
FAUCET COMPANY
GENUINE PARTS
LAVATORY, KITCHEN, TUB & SHOWER

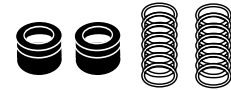

NEW STYLE SEATS WITH
OLD STYLE SPRINGS
(TO REPAIR MODELS
PRIOR TO 1972)

OLD STYLE

23-411 Genuine 4 Pc. Repair Kit **1.76**

DELTA
FAUCET COMPANY
GENUINE PARTS
LAVATORY, KITCHEN, TUB & SHOWER

#2 KIT
LESS WRENCH

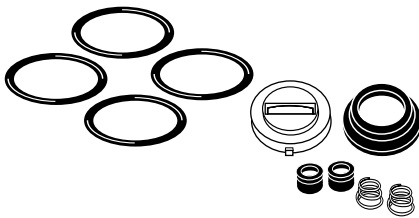

TO REPAIR ALL
SINGLE KNOB
FAUCETS

23-612 Genuine 10 Pc. Repair Kit **5.54**

DELTA
FAUCET COMPANY
GENUINE PARTS
LAVATORY, KITCHEN, TUB & SHOWER

(RP3616)

#2 KIT

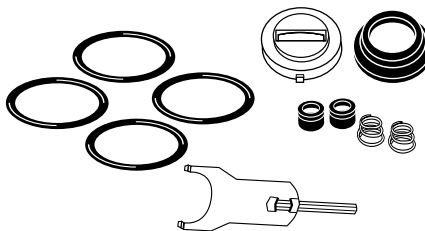

TO REPAIR ALL
SINGLE KNOB
FAUCETS

23-412 Genuine 11 Pc. Repair Kit **7.04**

DELTA
FAUCET COMPANY
GENUINE PARTS
LAVATORY, KITCHEN, TUB & SHOWER

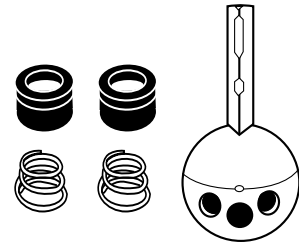

TO REPAIR ALL
SINGLE KNOB
FAUCETS

23-409 Genuine 5 Pc. Repair Kit **5.37**

DELTA
FAUCET COMPANY
GENUINE PARTS
LAVATORY, KITCHEN, TUB & SHOWER

DELTA
FAUCET COMPANY
GENUINE PARTS
LAVATORY, KITCHEN, TUB & SHOWER

DELTA
FAUCET COMPANY
GENUINE PARTS
LAVATORY, KITCHEN, TUB & SHOWER

REPAIR KITS

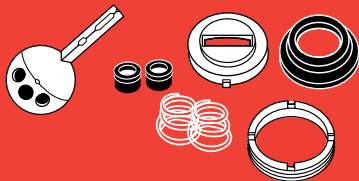

TO REPAIR ALL
SINGLE KNOB
FAUCETS

23-434 Genuine 8 Pc. Repair Kit **8.11**
23-608 Genuine 7 Pc. Repair Kit (less adj. ring) . **7.66**

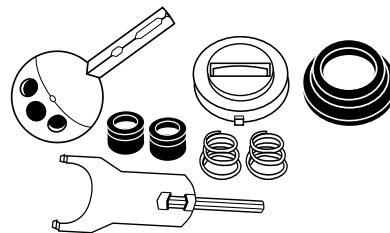

TO REPAIR ALL
SINGLE KNOB
FAUCETS

23-408 Genuine 8 Pc. Repair Kit **9.16**

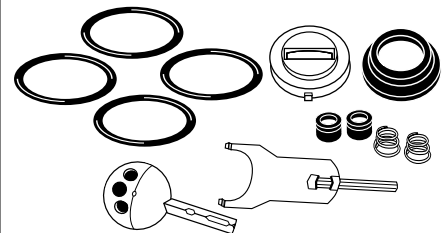

TO REPAIR ALL
SINGLE KNOB
FAUCETS

23-413 Genuine 12 Pc. Repair Kit **10.63**
23-813 Genuine 11 Pc. Less Wrench Repair Kit . **9.42**

USE YOUR CREDIT CARD AT TIME OF PURCHASE AND SAVE 2% ON ALL ORDERS, SAVE 5% ON ALL ORDERS OVER \$500 OR SAVE 10% ON ALL ORDERS OVER \$1000

FAX 1-800-982-5934 www. **HODES CO.** .com **PHONE 1-800-777-6500**
296 PROFERRED PLUMBING PRODUCTS

GENUINE DELTA REPAIR KITS

(PACKAGED IN ZIP-LOCK DISPLAY BAGS)



INTERNAL FAUCET REPAIR

DELTA
FAUCET COMPANY
GENUINE PARTS
LAVATORY, KITCHEN, TUB & SHOWER

OLD #1 KIT
LESS WRENCH

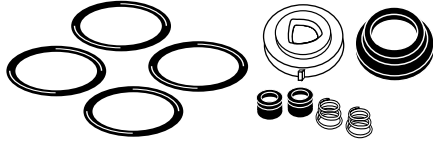

TO REPAIR ALL
SINGLE LEVER FAUCETS

23-602 Genuine 10 Pc. Repair Kit **7.00**

DELTA
FAUCET COMPANY
GENUINE PARTS
LAVATORY, KITCHEN, TUB & SHOWER

(RP3614)

OLD #1
KIT

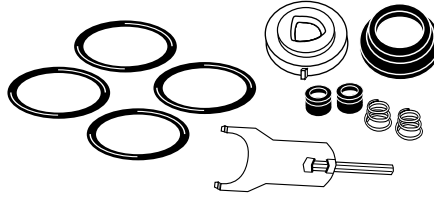

TO REPAIR ALL
SINGLE LEVER FAUCETS

23-402 Genuine 11 Pc. Repair Kit **8.77**

DELTA
FAUCET COMPANY
GENUINE PARTS
LAVATORY, KITCHEN, TUB & SHOWER

(RP3614)

NEW #1 KIT
INCLUDES BOTH CAMS



• To repair both single lever and single knob faucets!
• 1 per bar coded display package

23-814 Genuine 12 Pc. Repair Kit **9.34**
23-615 Genuine #1 Kit Less Wrench **8.15**

DELTA
FAUCET COMPANY
GENUINE PARTS
LAVATORY, KITCHEN, TUB & SHOWER

(RP61)

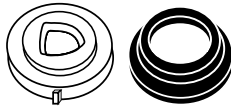

TO REPAIR ALL
SINGLE LEVER FAUCETS

23-403 Genuine 2 Pc. Repair Kit **2.73**

DELTA
FAUCET COMPANY
GENUINE PARTS
LAVATORY, KITCHEN, TUB & SHOWER

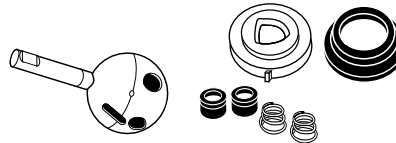

TO REPAIR ALL
SINGLE LEVER FAUCETS

23-604 Genuine 7 Pc. Repair Kit **8.19**

DELTA
FAUCET COMPANY
GENUINE PARTS
LAVATORY, KITCHEN, TUB & SHOWER

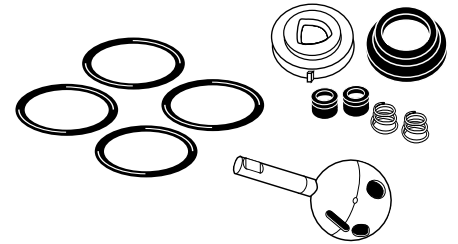

TO REPAIR ALL
SINGLE LEVER FAUCETS

23-606 Genuine 11 Pc. Repair Kit **9.95**

DELTA
FAUCET COMPANY
GENUINE PARTS
**SINGLE LEVER
WITH SPRAY
REPAIR KIT**

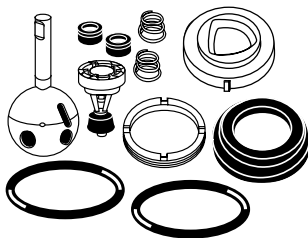

23-429 Genuine 11 Pc. Repair Kit **11.10**

DELTA
FAUCET COMPANY
GENUINE PARTS
**SINGLE LEVER
LESS SPRAY
REPAIR KIT**

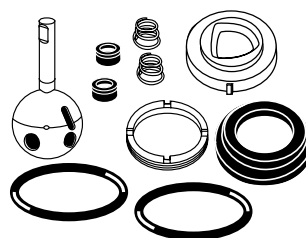

23-430 Genuine 10 Pc. Repair Kit **10.50**

DELTA
FAUCET COMPANY
GENUINE PARTS
LAVATORY, KITCHEN, TUB & SHOWER

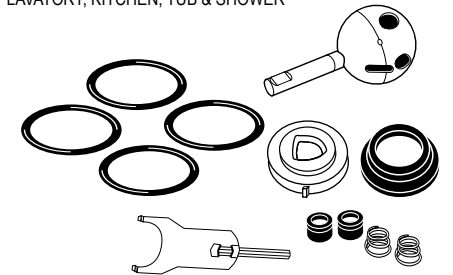

TO REPAIR ALL
SINGLE LEVER FAUCETS

23-406 Genuine 12 Pc. Repair Kit **11.10**

**USE YOUR CREDIT CARD AT TIME OF PURCHASE AND SAVE 2% ON ALL ORDERS,
SAVE 5% ON ALL ORDERS OVER \$500 OR SAVE 10% ON ALL ORDERS OVER \$1000**

**FAX
1-800-982-5934**

www.HODES CO.com
PROFFERED PLUMBING PRODUCTS

**PHONE
1-800-777-6500**
297

REPAIR KITS

INTERNAL FAUCET REPAIR



GENUINE DELTA REPAIR KITS
(PACKAGED IN ZIP-LOCK DISPLAY BAGS)

DELTA
FAUCET COMPANY
GENUINE PARTS
LAVATORY, KITCHEN, TUB & SHOWER

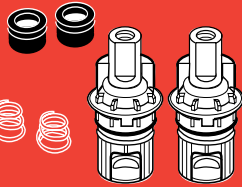

TO REPAIR ALL
TWO HANDLE
FAUCETS

23-401 Genuine 6 Pc. Repair Kit **10.18**

DELTA
FAUCET COMPANY
GENUINE PARTS
LAVATORY, KITCHEN, TUB & SHOWER

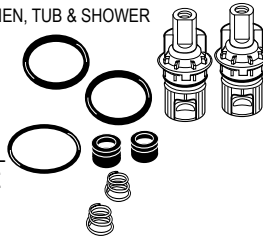

TO REPAIR ALL
TWO HANDLE
FAUCETS

23-414 Genuine 9 Pc. Repair Kit **11.14**

DELTA
FAUCET COMPANY
GENUINE PARTS
LAVATORY, KITCHEN, TUB & SHOWER



TO REPAIR ALL
TWO HANDLE
1/4 TURN FAUCETS

23-514 Genuine 1/4 Turn Repair Kit **48.22**



DELTA
FAUCET COMPANY
GENUINE PARTS

TWO HANDLE KITCHEN WITH SPRAY REPAIR KIT

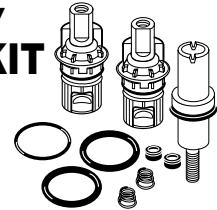

23-431 Genuine 10 Pc. Repair Kit **18.91**

DELTA
FAUCET COMPANY
GENUINE PARTS
LAVATORY, KITCHEN, TUB & SHOWER

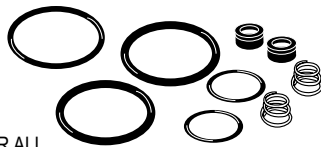

TO REPAIR ALL
TWO HANDLE
FAUCETS

23-410 Genuine 9 Pc. Repair Kit **4.40**

DELTA
FAUCET COMPANY
GENUINE PARTS
LAVATORY, KITCHEN, TUB & SHOWER

(RP25)

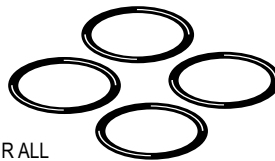

TO REPAIR ALL
SINGLE HANDLE
FAUCETS

23-416 Genuine 4 Pc. Repair Kit **2.73**

DELTA
FAUCET COMPANY
GENUINE PARTS
LAVATORY, KITCHEN, TUB & SHOWER

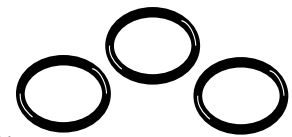

TO REPAIR ALL
TWO HANDLE
FAUCETS

23-417 Genuine 3 Pc. Repair Kit **2.58**

DELTA
FAUCET COMPANY
GENUINE PARTS
LAVATORY, KITCHEN, TUB & SHOWER



FOR TWO HANDLE
CARTRIDGES

23-418 Genuine 2 Pc. Repair Kit **1.53**

DELTA
FAUCET COMPANY
GENUINE PARTS
LAVATORY, KITCHEN, TUB & SHOWER

- 96 piece seat and spring assortment to repair all old and new style faucets
- Illustration chart in lid

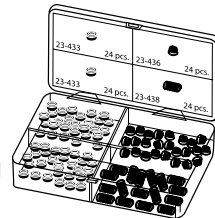

23-439 Genuine Delta Faucet Assort. Kit. . . **41.34**

DELTA
FAUCET COMPANY
GENUINE PARTS
LAVATORY, KITCHEN, TUB & SHOWER

(RP2932)

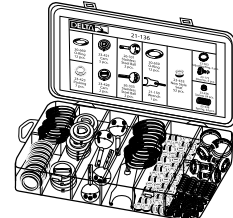

- 149 piece master repair kit to repair all Delta faucets
- Illustration chart in lid

21-136 Genuine Delta Faucet Assort. Kit. . . **94.48**

REPAIR KITS

USE YOUR CREDIT CARD AT TIME OF PURCHASE AND SAVE 2% ON ALL ORDERS, SAVE 5% ON ALL ORDERS OVER \$500 OR SAVE 10% ON ALL ORDERS OVER \$1000

FAX 1-800-982-5934 www.HODESCO.com PHONE 1-800-777-6500
298



GENUINE DELTA REPAIR KITS

(PACKAGED IN ZIP-LOCK DISPLAY BAGS)



INTERNAL FAUCET REPAIR

DELTA
FAUCET COMPANY
GENUINE PARTS
LAVATORY, KITCHEN, TUB & SHOWER

(RP212)
STAINLESS
STEEL

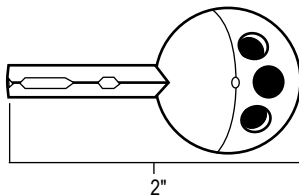

FOR SINGLE KNOB
FAUCETS

26-333 Genuine Ball Assembly **4.45**

DELTA
FAUCET COMPANY
GENUINE PARTS
LAVATORY, KITCHEN, TUB & SHOWER

(RP70)
STAINLESS
STEEL

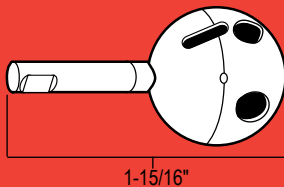

FOR SINGLE
LEVER FAUCETS

26-331 Genuine Ball Assembly **4.45**

DELTA
FAUCET COMPANY
GENUINE PARTS
LAVATORY, KITCHEN, TUB & SHOWER

(RP1740)
STAINLESS
STEEL
BOTTOM

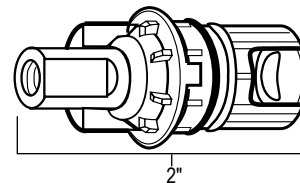

FOR TWO HANDLE
FAUCETS

26-437 Genuine Cartridge-Hot or Cold **4.45**

DELTA
FAUCET COMPANY
GENUINE PARTS
LAVATORY, KITCHEN, TUB & SHOWER

(RP8230)

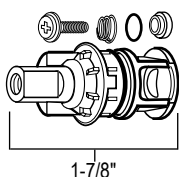

CERAMIC

• One per bar coded display bag

26-415 Genuine Cartridge **21.20**

DELTA
FAUCET COMPANY
GENUINE PARTS

(RP1991)

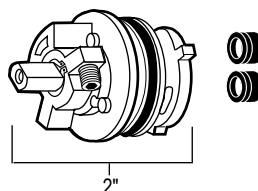

SCALDGUARD

• Includes two new style seats
• One per bar coded display bag

26-210 Genuine Cartridge **15.53**

DELTA
FAUCET COMPANY
GENUINE PARTS
REPLACEMENT CARTRIDGE

(RP32104)

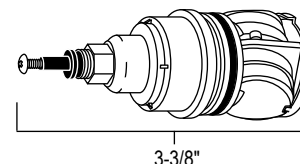

• Converts 1500 Series cartridge to new 1700 Series

26-214 Genuine Cartridge **83.51**

DELTA
FAUCET COMPANY
GENUINE PARTS

(RP10799)

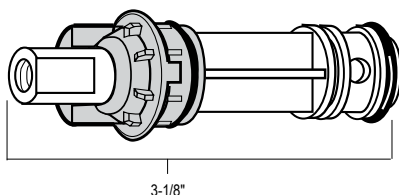

26-438 Genuine Cartridge **10.88**

DELTA
FAUCET COMPANY
GENUINE PARTS
TUB & SHOWER

(RP574)

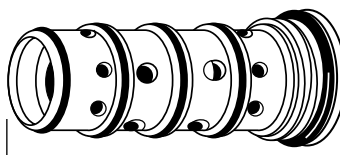

• One per bar coded display bag

26-305 Genuine Balancing Spool **66.00**

DELTA
FAUCET COMPANY
GENUINE PARTS

(RP19804)

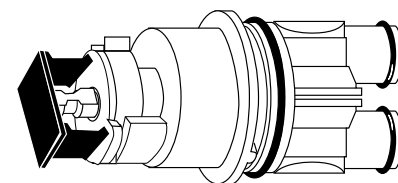

• Complete cartridge assembly with stainless steel plate
• For 1300 & 1400 series

26-211 Genuine Cartridge Assy. **35.13**

MONITOR®

**USE YOUR CREDIT CARD AT TIME OF PURCHASE AND SAVE 2% ON ALL ORDERS,
SAVE 5% ON ALL ORDERS OVER \$500 OR SAVE 10% ON ALL ORDERS OVER \$1000**

FAX
1-800-982-5934

www.HODESCO.com
PROFFERED PLUMBING PRODUCTS

PHONE
1-800-777-6500
299

REPAIR KITS

INTERNAL FAUCET REPAIR



GENUINE DELTA REPAIR KITS
(PACKAGED IN ZIP-LOCK DISPLAY BAGS)

DELTA
FAUCET COMPANY
GENUINE PARTS

(RP6073)

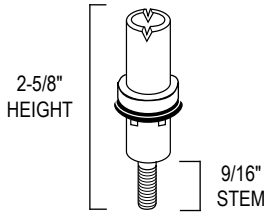

FOR
TWO HANDLE
FAUCETS

23-450 Genuine Diverter **9.06**

DELTA
FAUCET COMPANY
GENUINE PARTS

OLD# (RP12631)
NEW# (RP18627)

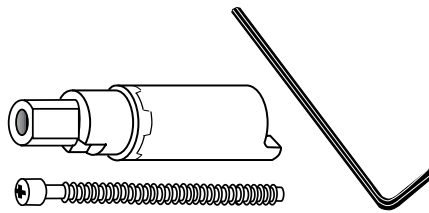

• One per bar coded display bag

26-347 Genuine Extender Assembly **3.17**

DELTA
FAUCET COMPANY
GENUINE PARTS
TUB & SHOWER DIVERTER

(RP5649)

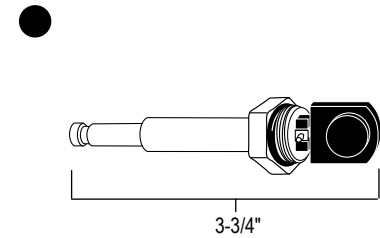

PUSH BUTTON

• One per bar coded display bag

26-311D Genuine Diverter **15.19**

DELTA
FAUCET COMPANY
GENUINE PARTS

(RP320)

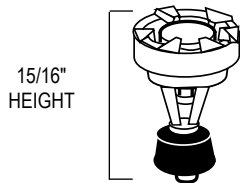

FOR
SINGLE LEVER
FAUCETS

SOLD 3 PER PACKAGE ONLY

23-172 Genuine Diverter **1.97**

Genuine Delta Parts
mean
no expensive call
backs

Hole
punched
for pegboard
storage

Reorder
Item#

Ziplock clear polybag
for easy access



Detailed
illustration
clearly defining
kit contents

Barcoding
means you'll
receive the
correct item.!

**Free Private
Labeling
Available.**

REPAIR KITS

DELTA
FAUCET COMPANY
GENUINE PARTS

LAVATORY, KITCHEN, TUB & SHOWER

CAM ONLY
FOR RP61

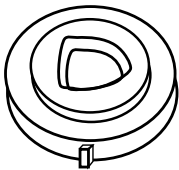

TO REPAIR ALL
SINGLE LEVER
FAUCETS

SOLD 10 PER PACKAGE ONLY

23-421 Genuine Cam **.69¢**

DELTA
FAUCET COMPANY
GENUINE PARTS

LAVATORY, KITCHEN, TUB & SHOWER

PACKING ONLY
FOR
RP61 & RP188



TO REPAIR ALL
SINGLE HANDLE
FAUCETS

SOLD 10 PER PACKAGE ONLY

23-423 Genuine Packing **1.47**

DELTA
FAUCET COMPANY
GENUINE PARTS

LAVATORY, KITCHEN, TUB & SHOWER

CAM ONLY
FOR RP188

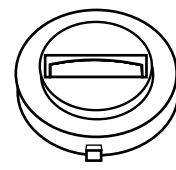

TO REPAIR ALL
SINGLE KNOB
FAUCETS

SOLD 10 PER PACKAGE ONLY

23-428 Genuine Cam **.69¢**

**USE YOUR CREDIT CARD AT TIME OF PURCHASE AND SAVE 2% ON ALL ORDERS,
SAVE 5% ON ALL ORDERS OVER \$500 OR SAVE 10% ON ALL ORDERS OVER \$1000**

FAX 1-800-982-5934 www.HODESCO.com PHONE 1-800-777-6500
300



GENUINE DELTA REPAIR KITS

(PACKAGED IN ZIP-LOCK DISPLAY BAGS)



INTERNAL FAUCET REPAIR

DELTA
FAUCET COMPANY
GENUINE PARTS
LAVATORY, KITCHEN, TUB & SHOWER

(RP250MB)

ADJUSTING RING
ONLY
FOR RP50

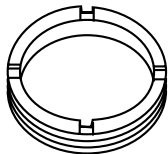

TO REPAIR ALL
SINGLE HANDLE
FAUCETS

SOLD 5 PER PACKAGE ONLY

23-303 Genuine Adjusting Ring **1.13**

DELTA
FAUCET COMPANY
GENUINE PARTS
LAVATORY, KITCHEN, TUB & SHOWER

(RP50)

CP BRASS CAP AND
ADJUSTING RING
(TO REPAIR ALL
SINGLE LEVER & KNOB
FAUCETS)

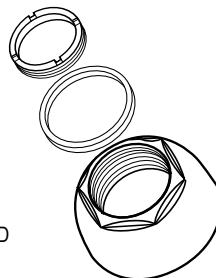

21-129 Genuine 3 Pc. Repair Kit **7.08**

DELTA
FAUCET COMPANY
GENUINE PARTS
LAVATORY, KITCHEN, TUB & SHOWER

(RP50)

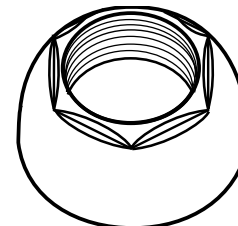

21-169 Genuine 1 Pc. CP Cap Only **5.90**

DELTA
FAUCET COMPANY
GENUINE PARTS
LAVATORY, KITCHEN, TUB & SHOWER

(RP1806MB)

NEW
STYLE
SEAT



TO REPAIR
ALL MODELS

SOLD 24 PER PACKAGE ONLY

23-433 Genuine Seat Washer **.59¢**

DELTA
FAUCET COMPANY
GENUINE PARTS
LAVATORY, KITCHEN, TUB & SHOWER

(RP3427MB)

NEW
STYLE
SHORT
SPRING

TO REPAIR
ALL MODELS

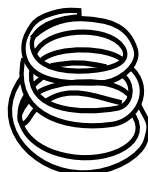

NEW STYLE

SOLD 24 PER PACKAGE ONLY

23-436 Genuine Short Spring **.40¢**

DELTA
FAUCET COMPANY
GENUINE PARTS
LAVATORY, KITCHEN, TUB & SHOWER

(RP1991)

OLD
STYLE
LONG
SPRING

TO REPAIR
ALL MODELS
INSTALLED PRIOR
TO 1972



OLD STYLE

SOLD 50 PER PACKAGE ONLY

23-438 Genuine Long Spring **.40¢**

DELTA
FAUCET COMPANY
GENUINE PARTS
LAVATORY, KITCHEN, TUB & SHOWER

(RP1974)

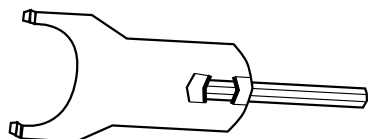

TO REPAIR ALL
SINGLE HANDLE
FAUCETS

21-150 Genuine Wrench **2.00**

DELTA
FAUCET COMPANY
GENUINE PARTS
LAVATORY, KITCHEN, TUB & SHOWER
*TWO NEEDED TO
REPAIR SPOUT LEAK

NEW STYLE
(RP25)

FOR
SINGLE HANDLE
KITCHEN DECK FAUCETS
MADE SINCE 1969
(EXCEPT PULL OUT
SPRAY MODELS)



NEW STYLE

SOLD 10 PER PACKAGE ONLY

20-659 Genuine O'Ring **.71¢**

DELTA
FAUCET COMPANY
GENUINE PARTS
KITCHEN

(RP 2331)

FOR
SINGLE HANDLE
KITCHEN FAUCET
SPOUTS
MADE BEFORE 1970

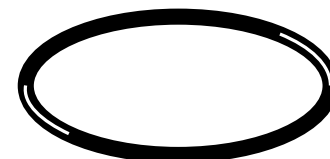

OLD STYLE

SOLD 10 PER PACKAGE ONLY

20-669 Genuine O'Ring **.71¢**

**USE YOUR CREDIT CARD AT TIME OF PURCHASE AND SAVE 2% ON ALL ORDERS,
SAVE 5% ON ALL ORDERS OVER \$500 OR SAVE 10% ON ALL ORDERS OVER \$1000**

FAX
1-800-982-5934

www. **HODES CO.** .com
PREFERRED PLUMBING PRODUCTS

PHONE
1-800-777-6500
301

REPAIR KITS

INTERNAL FAUCET REPAIR



FAUCET REPAIR KITS
(PACKAGED IN ZIP-LOCK DISPLAY BAGS)



**PAY BY MAJOR CREDIT CARD
WHEN YOU PLACE YOUR ORDER
AND SAVE UP TO AN
ADDITIONAL 10%
OFF OUR ALREADY
INDUSTRY-LOW PRICES!!**



(RP 1732)

LAVATORY, KITCHEN, TUB & SHOWER

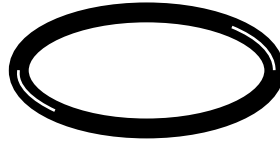

FOR
TWO HANDLE
FAUCET SPOUTS

SOLD 10 PER PACKAGE ONLY

20-665 Genuine O'Ring **.70¢**



(RP 12867)

LAVATORY, KITCHEN, TUB & SHOWER



FOR EXTERNAL
TWO HANDLE
FAUCET CARTRIDGES

SOLD 10 PER PACKAGE ONLY

20-668 Genuine O'Ring **.66¢**



(RP 1745)

LAVATORY, KITCHEN, TUB & SHOWER

*ONE USED
IN 23-417 KIT

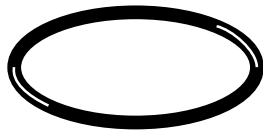

FOR
TWO HANDLE
FAUCET SPOUTS

SOLD 10 PER PACKAGE ONLY

20-667 Genuine O'Ring **.55¢**



(RP 1715)

TUB & SHOWER



FOR 1600
SERIES
SCALDGUARD
FAUCETS

FOR 26-210
INTERNAL STEM
UNIT

SOLD 10 PER PACKAGE ONLY

20-663 Genuine O'Ring **.70¢**



(023571)

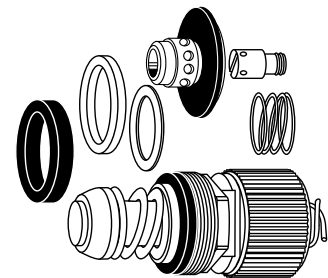

24-358 Genuine Repair Kit **41.08**

For GERBER
TUB & SHOWER

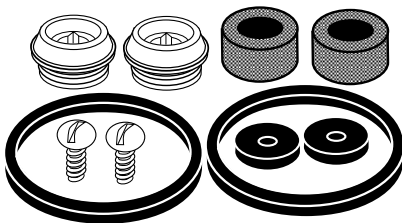

*Not Available From Gerber.

22-766 *Generic 10 Pc. Repair Kit **4.40**

For GERBER

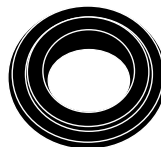

SOLD 5 PER PACKAGE ONLY

21-166 Generic Cartridge Washer **.55¢**



(22213)

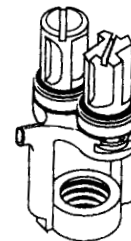

YOKE ASSEMBLY NIEDECKEN

22-808 Genuine Yoke Assembly Repair Kit. **64.59**

REPAIR KITS

**USE YOUR CREDIT CARD AT TIME OF PURCHASE AND SAVE 2% ON ALL ORDERS,
SAVE 5% ON ALL ORDERS OVER \$500 OR SAVE 10% ON ALL ORDERS OVER \$1000**

FAX 1-800-982-5934 www.HODESCO.com PHONE 1-800-777-6500
302



FAUCET REPAIR KITS

(PACKAGED IN ZIP-LOCK DISPLAY BAGS)



INTERNAL FAUCET REPAIR

KOHLER

(30090)

TUB & SHOWER

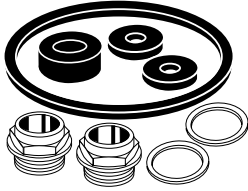

NIEDECKEN

22-810 Genuine 8 Pc. Repair Kit **24.74**

For **KOHLER** (WITH CELCON PLUNGERS)

LAVATORY, KITCHEN, TUB & SHOWER

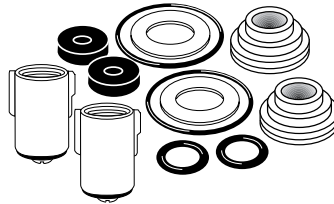

*Not Available From Kohler

VALVET

21-179 *Generic 12 Pc. Repair Kit **8.50**

For **KOHLER**

(WITH BRASS PLUNGERS)

LAVATORY, KITCHEN, TUB & SHOWER

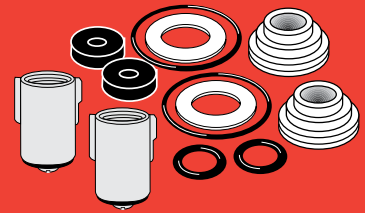

*Not Available From Kohler

VALVET

21-181 *Generic 12 Pc. Repair Kit **8.86**

KOHLER

(785790)



NEW

22-813 Genuine 8 Pc. Repair Kit **12.17**

For **MOEN**

LAVATORY, KITCHEN, TUB & SHOWER

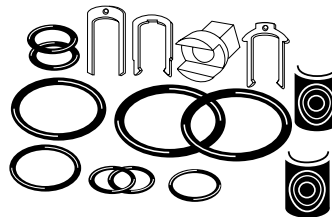

*Not Available From Moen

22-633 *Generic 15 Pc. Repair Kit **4.71**

For **MOEN**

LAVATORY, KITCHEN, TUB & SHOWER

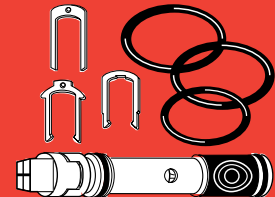

*Not Available From Moen

26-801 *Generic 7 Pc. Cartridge Kit **9.93**

For **MOEN**

LAVATORY, KITCHEN, TUB & SHOWER

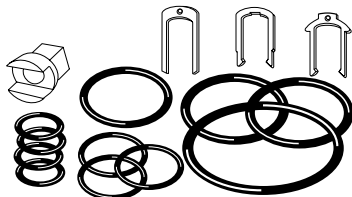

*Not Available From Moen

22-634 *Generic 15 Pc. Repair Kit **4.31**

MOEN

(98040)

POSI-TEMP® CARTRIDGE REPAIR KIT

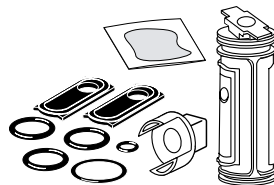

For **MOEN**

22-635 Generic ... **4.55**

22-630 Genuine Moen Repair Kit **15.23**

MOEN

(117)

KITCHEN

SPOUT O'RING KIT

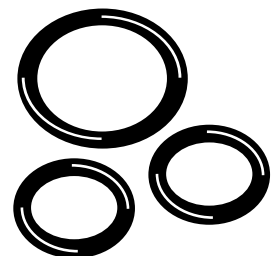

22-799 Genuine 3 Pc. Repair Kit **5.37**

22-801 Generic 3 Pc. Repair Kit **1.66**

MOEN

(93980)

HANDLE MECHANISM KIT

- For 7400, 7600, 7700 Models single handle kitchen faucets
- White pivot stop used on 7400/7600 series
- Gray pivot stop used on 7700 series

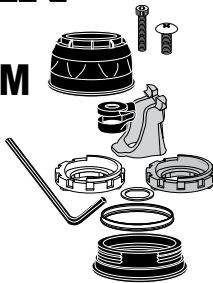

22-770 Genuine Handle Kit **25.38**

USE YOUR CREDIT CARD AT TIME OF PURCHASE AND SAVE 2% ON ALL ORDERS, SAVE 5% ON ALL ORDERS OVER \$500 OR SAVE 10% ON ALL ORDERS OVER \$1000

FAX **1-800-982-5934**

www. **HODES CO.** .com
PREFERRED PLUMBING PRODUCTS

PHONE **1-800-777-6500**
303

REPAIR KITS

INTERNAL FAUCET REPAIR



FAUCET REPAIR KITS
(PACKAGED IN ZIP-LOCK DISPLAY BAGS)

MOEN®
KITCHEN HANDLE
REPAIR KIT

(100429)



- For Model # 7850, 7560, 7400, 7600, 7700, 7000
- Includes cartridge screw, adapter, connector, set screw

22-771 Genuine Kitchen Repair Kit **5.62**

MOEN®
HANDLE CONNECTOR
SERVICE KIT

(101099)



- For Models # 7385, 7210
- Includes handle screw & connector, washer and spacer

22-772 Genuine Handle Repair Kit **5.62**

MOEN®
KITCHEN FIT PIVOT
RETAINER
SERVICE KIT

(14699)



- Kitchen Fit Pivot Retainer Service Kit
- For single handle, lever handle kitchen models

22-645 Genuine Repair Kit **6.39**

For MOEN
LAVATORY,
KITCHEN,
TUB & SHOWER

(883)

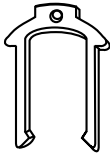

BRASS
CARTRIDGE
CLIP

- Replacement retainer clip for Moen 1200 cartridge when used in single acrylic lavatory or tub and shower faucets

SOLD 10 PER PACKAGE ONLY

26-905 Generic Cartridge Clip **.83¢**



www.HodesCo.com

**Orders Placed by 4:00 p.m.(EST)
Shipped the Same Day
3 Easy Ways to Order!**

Online: www.HodesCo.com
Call: 1-800-777-6500
Fax: 1-800-982-5934

**USE YOUR CREDIT CARD AT TIME OF PURCHASE AND SAVE 2% ON ALL ORDERS,
SAVE 5% ON ALL ORDERS OVER \$500 OR SAVE 10% ON ALL ORDERS OVER \$1000**

FAX 1-800-982-5934 www.HODESCO.com PHONE 1-800-777-6500
304

REPAIR KITS

FAUCET REPAIR KITS

(PACKAGED IN ZIP-LOCK DISPLAY BAGS)



INTERNAL FAUCET REPAIR

For PRICE PFISTER

(949-360)

LAVATORY & KITCHEN

BOTTOM SEAL
FOR TWO HANDLE
CARTRIDGE

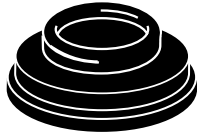

SOLD 10 PER PACKAGE ONLY

21-186 Generic Soft Washer **.94¢**

For PRICE PFISTER

TUB & SHOWER

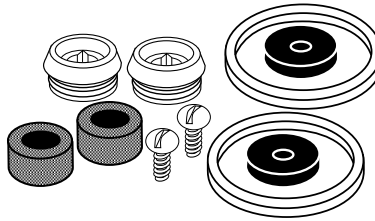

*Not Available From
Price Pfister

22-621 *Generic 10 Pc. Repair Kit **3.52**

For SAYCO

TUB & SHOWER

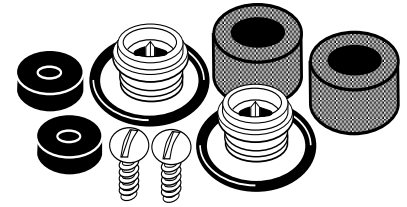

*Not Available
From Sayco

22-626 *Generic 10 Pc. Repair Kit **3.52**

SPEAKMAN
REPAIR KIT

(0016)

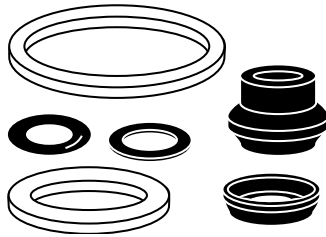

21-194 Genuine S/P 6 Piece Repair Kit ... **22.42**

For STERLING

TUB & SHOWER

(05030)

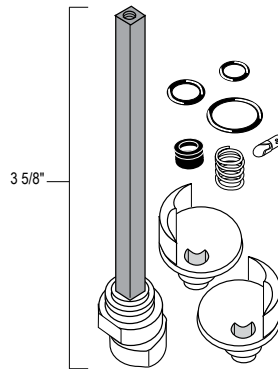

26-243 Generic 10 Pc. Repair Kit **9.42**

For STERLING

LAVATORY & KITCHEN

(05050)

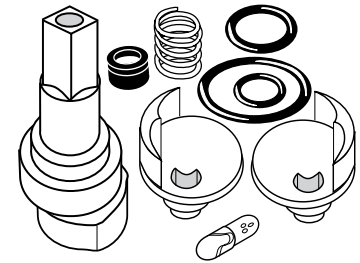

26-239 Generic 9 Pc. Repair Kit **5.11**

For STERLING

LAVATORY, KITCHEN, TUB & SHOWER

(A1311)



SEATS AND SPRINGS
REPAIR
SINGLE CONTROL FAUCETS

20-199 Generic 4 Pc. Repair Kit **2.35**

For STERLING

LAVATORY, KITCHEN, TUB & SHOWER

(A1408)



SEATS AND SPRINGS
REPAIR
TWO HANDLE FAUCETS

20-299 Generic 4 Pc. Repair Kit **2.20**

STERLING

LAVATORY, KITCHEN, TUB & SHOWER

(A1408)



SEATS AND SPRINGS
REPAIR
TWO HANDLE FAUCETS

20-499 Genuine 4 Pc. Repair Kit **3.79**

GENUINE COMPARE

**USE YOUR CREDIT CARD AT TIME OF PURCHASE AND SAVE 2% ON ALL ORDERS,
SAVE 5% ON ALL ORDERS OVER \$500 OR SAVE 10% ON ALL ORDERS OVER \$1000**

FAX 1-800-982-5934

www.HODES CO.com
PROFFERED PLUMBING PRODUCTS

PHONE 1-800-777-6500
305

REPAIR KITS

INTERNAL FAUCET REPAIR



FAUCET REPAIR KITS
(PACKAGED IN ZIP-LOCK DISPLAY BAGS)

Symmons
SHOWER

(TA-9)

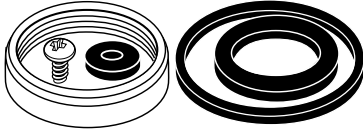

TEMPROL

22-468 Generic 5 Pc. Repair Kit **7.67**



(2714)
(2713)

SPINDLE ASSEMBLY

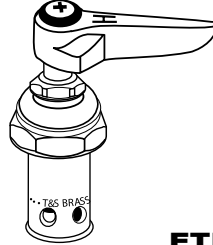

ETERNA

10-386 Genuine RH Hot Spindle Assembly **53.90**
10-387 Genuine RH Cold Spindle Assembly **53.90**



(002711-40)
(002712-40)

SPINDLE ASSEMBLY WITH SPRING CHECK

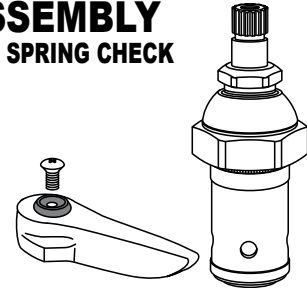

27-708 Genuine LH Cold Cartridge **55.24**
27-707 Genuine RH Hot Cartridge **55.24**



SINK

(B-10K)

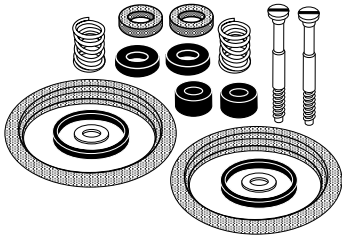

TO REPAIR
SQUEEZE VALVE OF
PRE-RINSE UNIT

10-373 Genuine 18 Pc. Repair Kit **22.18**

**For UNIVERSAL RUNDLE/
MILWAUKEE/SEARS**

LAVATORY, KITCHEN, TUB & SHOWER

(P8184)

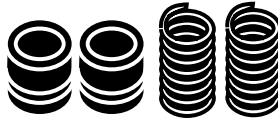

FOR
TWO HANDLE
FAUCETS

21-183 Generic 4 Pc. Repair Kit **1.77**



**PAY BY MAJOR CREDIT CARD
WHEN YOU PLACE YOUR ORDER
AND SAVE UP TO AN
ADDITIONAL 10%
OFF OUR ALREADY
INDUSTRY-LOW PRICES!!**

For VALLEY

LAVATORY, KITCHEN, TUB & SHOWER

(V1001)

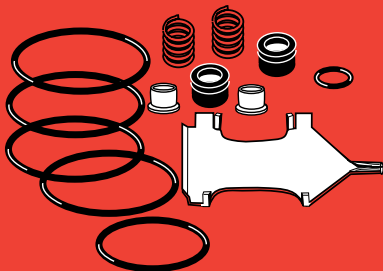

21-193 Generic 13 Pc. Repair Kit **2.94**

For VALLEY

LAVATORY, KITCHEN, TUB & SHOWER

(V7059)

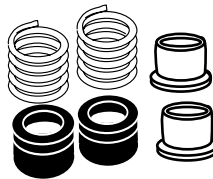

INLET SEALS
AND SPRINGS

21-253 Generic 6 Pc. Repair Kit **1.12**

Valley

LAVATORY, KITCHEN, TUB & SHOWER

(V7059)

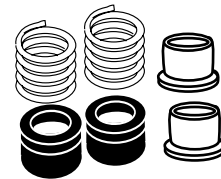

INLET SEALS
AND SPRINGS

21-257 Genuine 6 Pc. Repair Kit **2.30**

GENUINE COMPARE

**USE YOUR CREDIT CARD AT TIME OF PURCHASE AND SAVE 2% ON ALL ORDERS,
SAVE 5% ON ALL ORDERS OVER \$500 OR SAVE 10% ON ALL ORDERS OVER \$1000**

FAX
1-800-982-5934
306

www. **HODES CO.** .com
PREFERRED PLUMBING PRODUCTS

PHONE
1-800-777-6500

REPAIR KITS

BOXED REPAIR KITS



INTERNAL FAUCET REPAIR

COMPARTMENT CLEAR ASSORTMENT BOX ONLY

4 COMPARTMENT CLEAR ASSORTMENT BOX ONLY

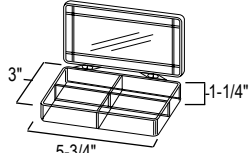

• 36 per case
25-439 4-Compartment Box . 2.95

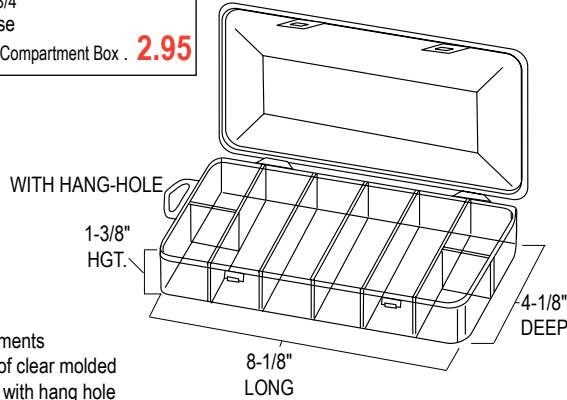

• 8 Compartments
 • Shatterproof clear molded plastic box with hang hole

88-440 Assortment Box Only with Hang Hole 4.08

BONNET PACKINGS

ASSORTMENTS MEAN CONVENIENCE AND TIME SAVINGS. EACH KIT INCLUDES THE MOST POPULAR FAUCET REPAIR PARTS IN A DURABLE CLEAR PLASTIC BOX.

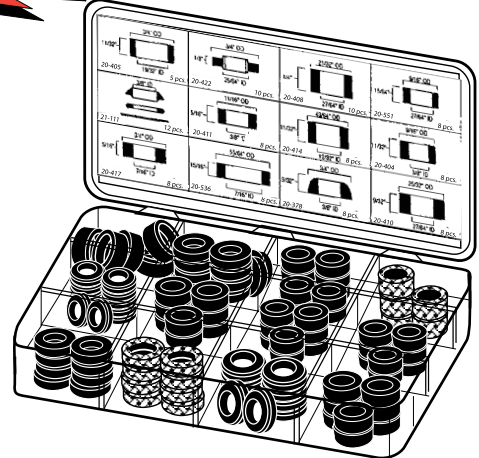

• 98 assorted faucet stem bonnet packings
 • Illustration chart in lid
 • 12 popular sizes

20-965 98 Pc. Bonnet Packing Assortment Kit 66.77



LAVATORY, KITCHEN, SINK & BAR

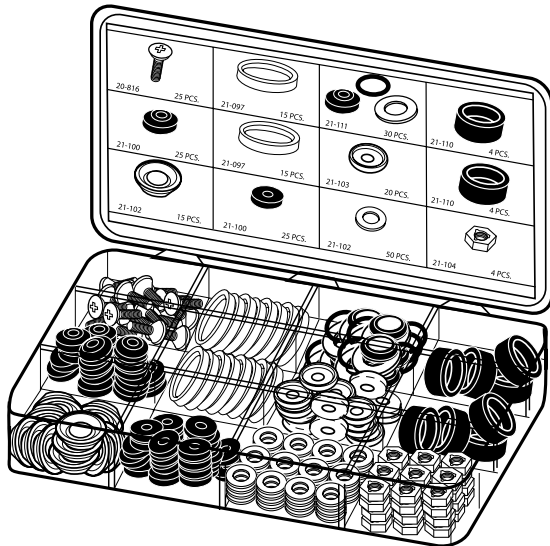

• 268 piece Quatern repair kit
 • Illustration chart in lid

21-157 Genuine Chicago Quatern Assortment Kit 191.80

For CRANE

LAVATORY, KITCHEN, TUB & SHOWER

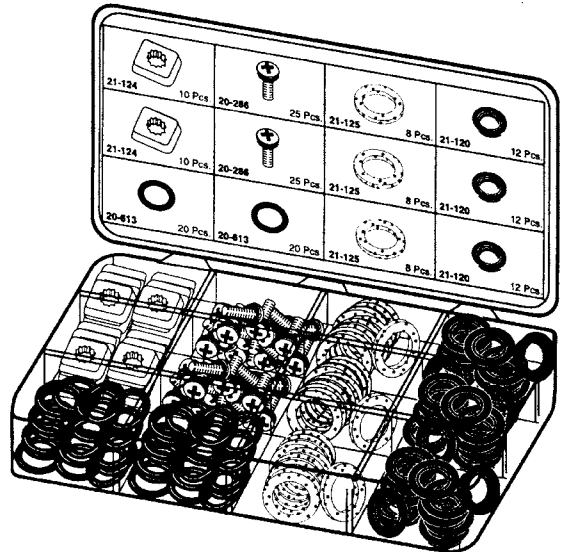

• 170 piece Dialeze repair kit
 • Illustration chart in lid

21-127 Generic Dialeze Assortment Kit 44.92

USE YOUR CREDIT CARD AT TIME OF PURCHASE AND SAVE 2% ON ALL ORDERS, SAVE 5% ON ALL ORDERS OVER \$500 OR SAVE 10% ON ALL ORDERS OVER \$1000

FAX 1-800-982-5934 www.HODES CO.com PHONE 1-800-777-6500



INTERNAL FAUCET REPAIR



BOXED REPAIR KITS

DELTA
FAUCET COMPANY
GENUINE PARTS

LAVATORY, KITCHEN, TUB & SHOWER

(RP4039)

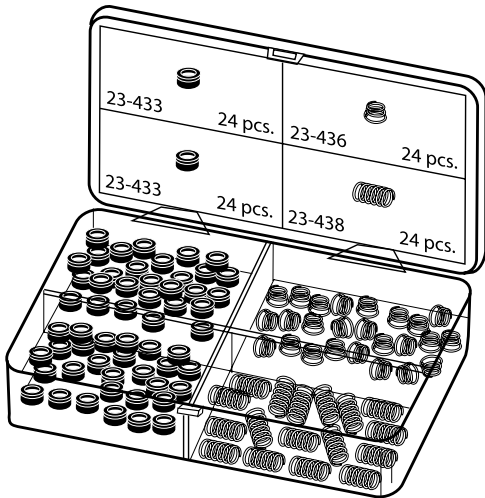

- 96 piece seat and spring assortment to repair all old and new style faucets
- Illustration chart in lid

23-439 Genuine Delta Faucet Assortment Kit **41.34**

DELTA
FAUCET COMPANY
GENUINE PARTS

LAVATORY, KITCHEN, TUB & SHOWER

(RP2932)

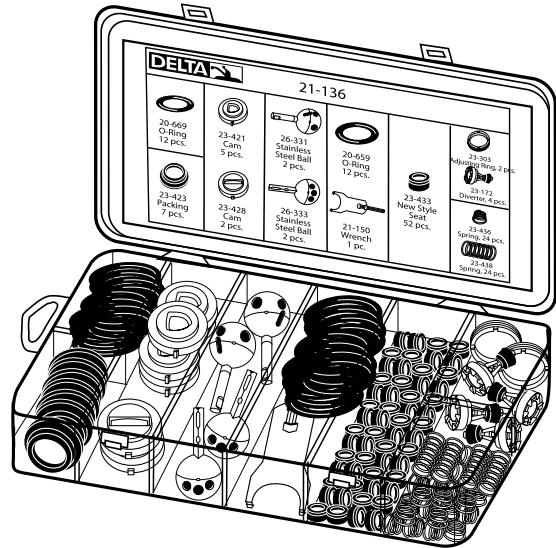

- 149 piece master repair kit to repair all delta faucets
- Illustration chart in lid

21-136 Genuine Delta Faucet Assortment Kit **94.48**

DELTA
FAUCET COMPANY
GENUINE PARTS

LAVATORY, KITCHEN, TUB & SHOWER

(RP25838)

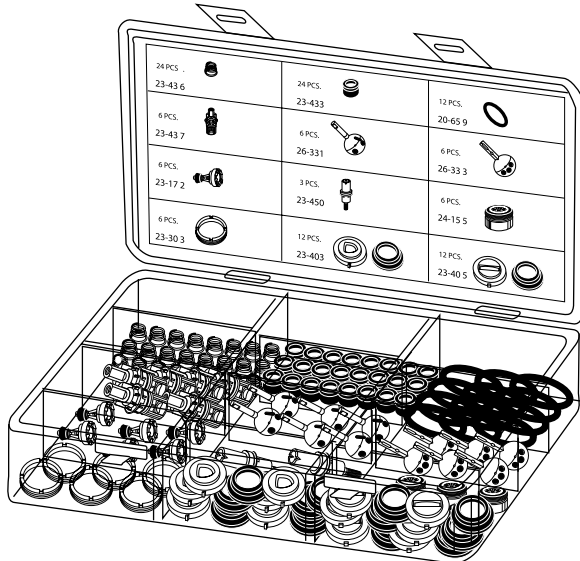

- 123 piece assortment
- Illustration chart in lid

21-134 Genuine Delta Repair Parts Kit **175.85**

DELTA
FAUCET COMPANY
GENUINE PARTS

LAVATORY, KITCHEN, TUB & SHOWER

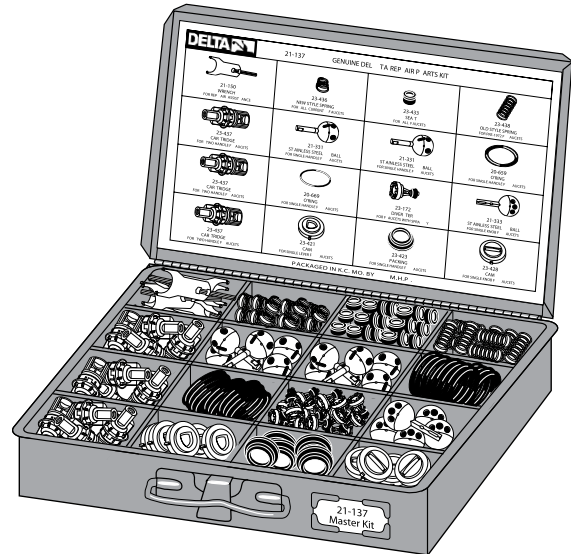

- 289 piece jumbo master repair kit to repair all models
- Illustration chart in lid

21-137 Genuine Delta Master Faucet Assortment **618.42**

BOXED REPAIR KITS

USE YOUR CREDIT CARD AT TIME OF PURCHASE AND SAVE 2% ON ALL ORDERS, SAVE 5% ON ALL ORDERS OVER \$500 OR SAVE 10% ON ALL ORDERS OVER \$1000

FAX 1-800-982-5934 www.HODES CO.com PHONE 1-800-777-6500
308 **HODES CO.** PREFERRED PLUMBING PRODUCTS

BOXED REPAIR KITS



INTERNAL FAUCET REPAIR

For KOHLER

LAVATORY, KITCHEN, TUB & SHOWER

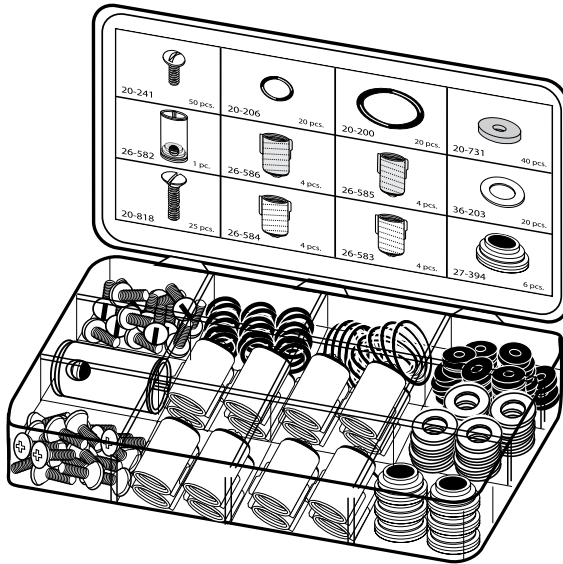

- 198 piece valvet repair kit
- Illustration chart in lid

21-158 Generic Valvet Assortment Kit **44.92**

For MOEN

LAVATORY, KITCHEN, TUB & SHOWER

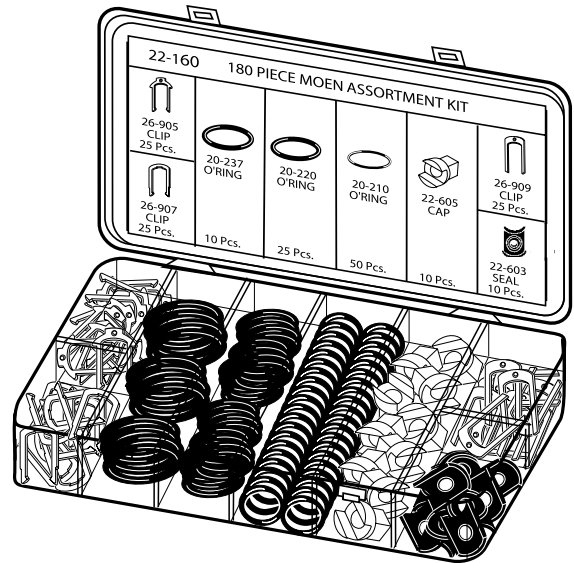

- 180 piece Moen assortment kit
- Illustration chart in lid

21-160 Generic Moen Assortment Kit **47.01**

CAP GASKETS

LAVATORY, KITCHEN, TUB & SHOWER

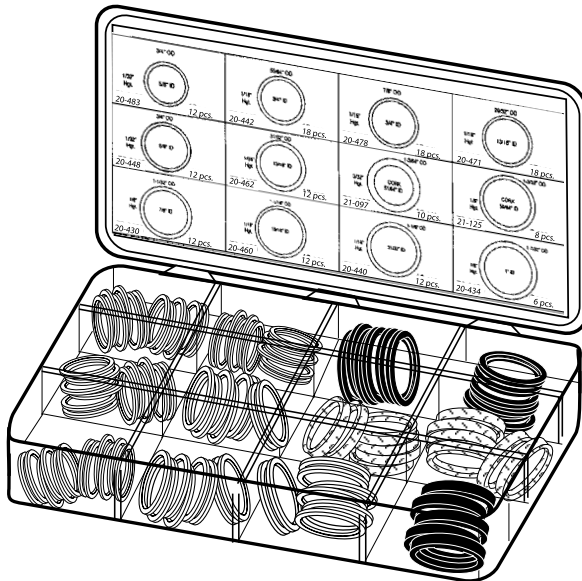

- 150 assorted cap thread gaskets
- Illustration chart in lid
- 12 popular sizes

20-517 150 Pc. Cap Gasket Assortment Kit **31.76**

CAP GASKETS

LAVATORY, KITCHEN, TUB & SHOWER

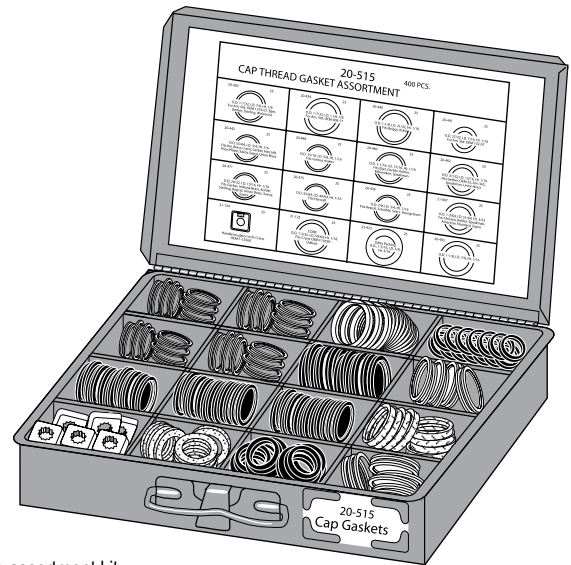

- 400 piece assortment kit
- Illustration chart in lid
- 14 popular sizes
- Metal box with lock & handle
- Also included in 20-145 parts cabinet shown on page # 313

20-515 400 Pc. Cap Gasket Assortment Kit **177.40**

USE YOUR CREDIT CARD AT TIME OF PURCHASE AND SAVE 2% ON ALL ORDERS, SAVE 5% ON ALL ORDERS OVER \$500 OR SAVE 10% ON ALL ORDERS OVER \$1000

FAX 1-800-982-5934 www.HODES CO.com PHONE 1-800-777-6500





O'RING ASSORTMENT KIT

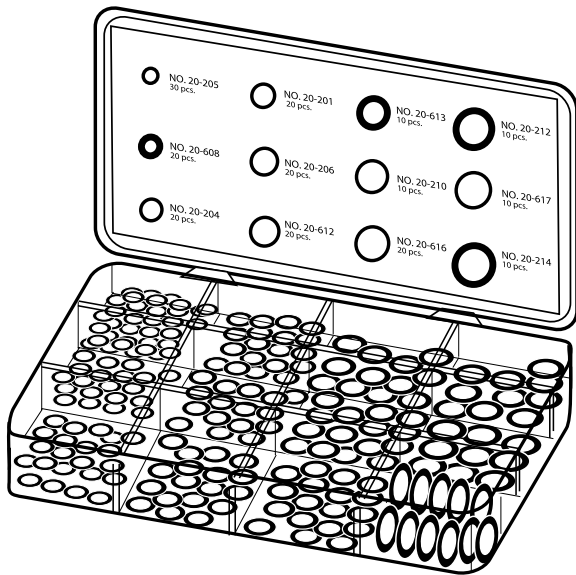

- 200 assorted O'Rings
- Illustration chart in lid
- 12 popular sizes

20-234 200 Pc. O'Ring Assortment Kit **12.96**

JUMBO O'RING KIT

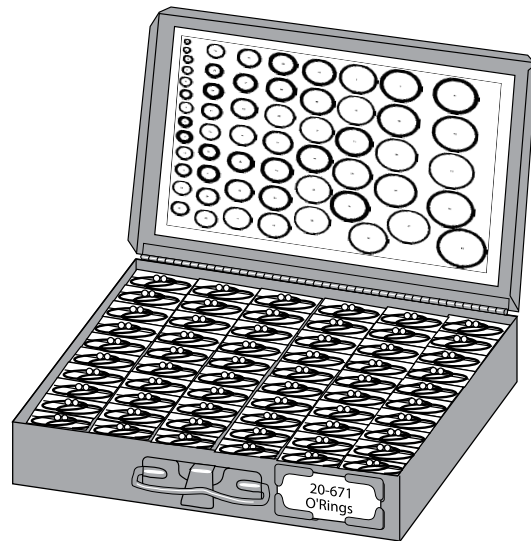

- 502 piece assortment kit
- Illustration chart in lid
- 60 different O'Rings packaged in individual clear plastic boxes for easy identification and access
- Metal box with lock & handle

20-671 502 Pc. Buna-N O'Ring Assortment Kit **132.24**

**O'RING
SPLICING KIT**

THIS SPLICING KIT CONTAINS ALL OF THE MATERIALS NECESSARY TO PROVIDE STATIONARY O'RINGS ON THE SPOT. IDEAL AS A SUPPLEMENT TO YOUR EXISTING O-RING INVENTORY TO ELIMINATE DOWNTIME DELAYS FROM OUT OF STOCK SITUATIONS, OR AS A HANDY FIELD REPAIR KIT. SAVES TIME BY ALLOWING O-RING REPLACING WITHOUT DISASSEMBLING MACHINERY. O-RING CORD IS MADE OF HIGH QUALITY BUNA-N RUBBER.

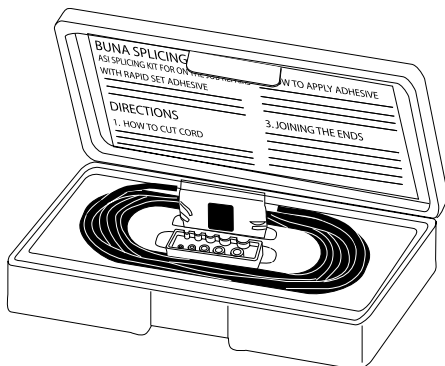

- Kit Contains:
- 3 oz. bottle of adhesive
- Splicing fixture
- razor blade
- 6' x 3/32" Buna-N cord
- 6' x 1/8" Buna-N cord
- 6' x 3/16" Buna-N cord
- 6' x 1/4" Buna-N cord

20-230 O'Ring Splicing Kit **41.03**

**CHROME PLATED
HANDLE SCREWS**

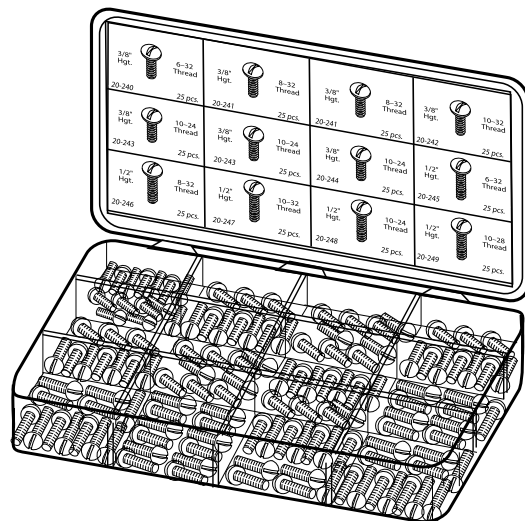

- 300 assorted chrome plated handle screws
- Illustration chart in lid
- 12 popular sizes

20-839 300 Pc. CP Handle Screw Assortment Kit **64.30**

BOXED REPAIR KITS

**USE YOUR CREDIT CARD AT TIME OF PURCHASE AND SAVE 2% ON ALL ORDERS,
SAVE 5% ON ALL ORDERS OVER \$500 OR SAVE 10% ON ALL ORDERS OVER \$1000**

FAX 1-800-982-5934 www.HODES CO.com PHONE 1-800-777-6500
310 **HODES CO.** PREFERRED PLUMBING PRODUCTS

BOXED REPAIR KITS



INTERNAL FAUCET REPAIR

100 PIECE MULTI-COLORED BUNA-N FAUCET WASHERS ASSORTMENT



20-971



20-973

- Different colors save time searching for needed size
- Packaged in resealable white container
- Sizes shown on washers
- Durable Buna-N rubber

20-971 100 Pc. Flat Faucet Washer Kit **9.41**

20-973 100 Pc. Beveled Faucet Washer Kit **9.41**

MULTI-COLORED BUNA-N (NITRILE) BIBB WASHER ASSORTMENT CHEST

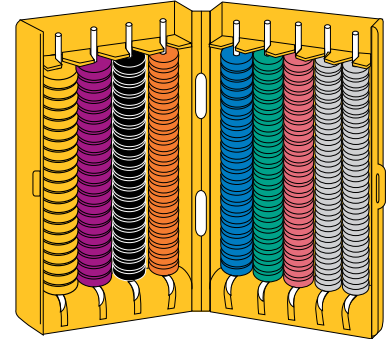

- Colors save you time and money searching for needed size
- Chest measures 3-1/2"W x 6-1/2"H x 2"D
- Sturdy (tool box like) unit contains eight popular sizes
- Features snap lock clasp & living hinge
- (Gets stronger each time you flex it)
- Convenient washer size chart on the inside of the kit

20-964 NOW HAS 70 MORE WASHERS

20-964 370 Piece Flat Washer Chest **32.42**

20-966 170 Piece Bevelled Washer Chest **26.94**

BUNA-N MULTI-COLORED BIBB WASHERS



- 200 assorted Buna-N faucet washers
- Illustration chart in lid
- 8 popular sizes

20-960 200 Pc. Buna-N Multi-Colored Flat Bibb Washer Kit **17.69**

20-962 200 Pc. Buna-N Multi-Colored Beveled Bibb Washer Kit **17.69**

800 PIECE MULTI-COLORED BUNA-N (NITRILE) BIBB WASHER BOXED ASSORTMENT

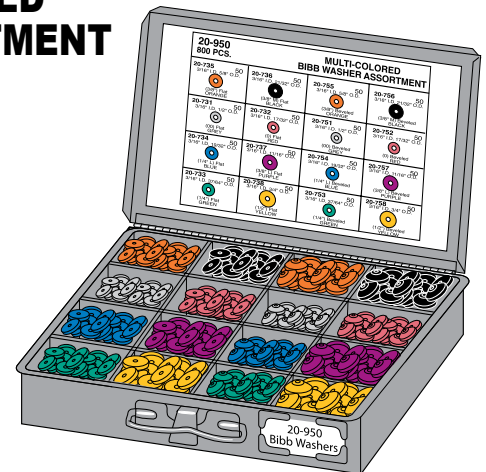

- Contains 400 flat and 400 bevelled bibb washers
- Sizes shown on washers
- Colors save you time and money searching for needed size
- Heavy steel box with lock and handle

20-950 Bibb Washer Assortment **141.38**

USE YOUR CREDIT CARD AT TIME OF PURCHASE AND SAVE 2% ON ALL ORDERS, SAVE 5% ON ALL ORDERS OVER \$500 OR SAVE 10% ON ALL ORDERS OVER \$1000

FAX 1-800-982-5934 www.HODES CO.com PHONE 1-800-777-6500



INTERNAL FAUCET REPAIR



BOXED REPAIR KITS

BRASS FAUCET SEATS

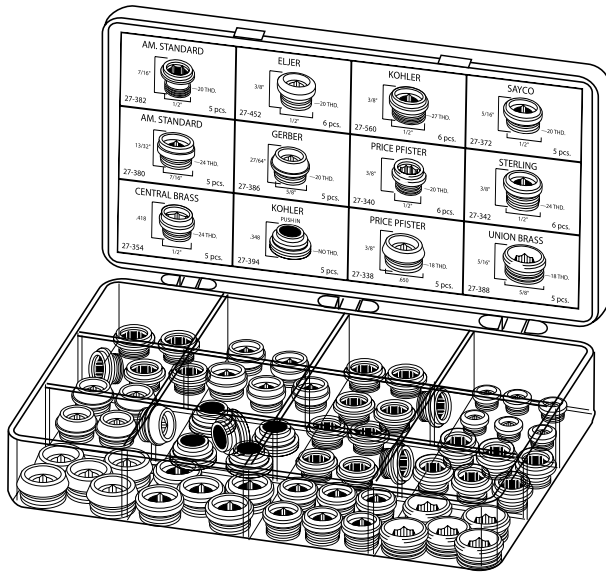

- 64 assorted renewable brass faucet seats
- Illustration chart in lid
- 12 popular sizes

27-402 64 Pc. Brass Faucet Seat Assortment Kit **47.20**

BRASS BIBB SCREWS

NOW COMES WITH T-HANDLE TAP!

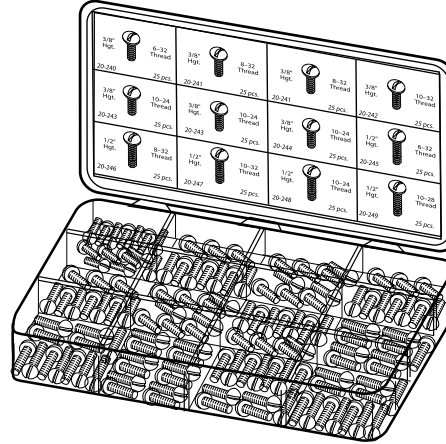
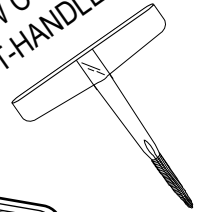

- 300 assorted brass bibb screws
- Illustration chart in lid
- 10 popular sizes

20-953 300 Pc. Brass Bibb Screw Assortment Kit **47.01**

BRASS FAUCET SEATS

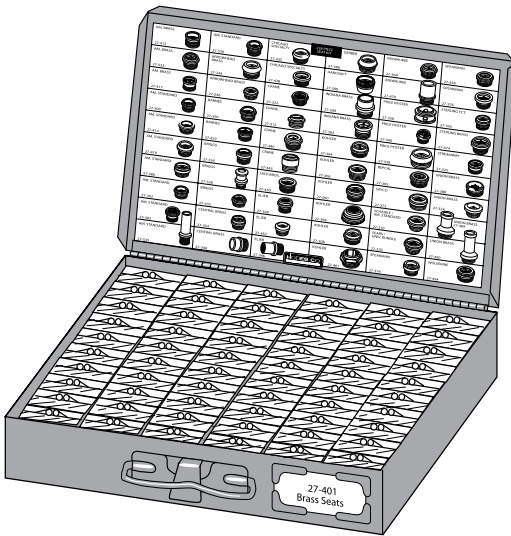

- 238 piece assortment kit
- Illustration chart in lid
- popular sizes in individual plastic boxes for easy identification and access
- Heavy metal box with lock & handle
- Also included in 20-145 parts cabinet shown on page 313

27-401 238 Pc. Brass Faucet Seat Assortment Kit **218.53**

Genuine Delta Parts mean no expensive call backs

Hole punched for pegboard storage

Reorder Item#

Ziplock clear polybag for easy access



Detailed illustration clearly defining kit contents

Barcoding means you'll receive the correct item!

WHY HODES CO?
BECAUSE LIFE'S TOO SHORT TO BE ANYTHING BUT SATISFIED

ISO 9001:2000 QUALITY SYSTEM CERTIFIED

USE YOUR CREDIT CARD AT TIME OF PURCHASE AND SAVE 2% ON ALL ORDERS, SAVE 5% ON ALL ORDERS OVER \$500 OR SAVE 10% ON ALL ORDERS OVER \$1000

FAX 1-800-982-5934 www.HODESCO.com PHONE 1-800-777-6500
312

BOXED REPAIR KITS



INTERNAL FAUCET REPAIR

BRASS BIBB RETAINERS

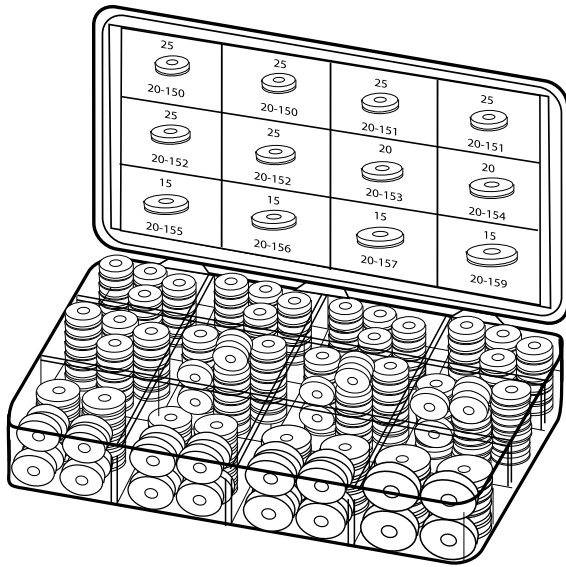

- 250 assorted brass bibb retainers
- Illustration chart in lid
- 9 popular sizes

20-173 250 Pc. Brass Bibb Retainer Assortment Kit **100.38**

"NO-ROTATE" FLAT SEAT WASHERS

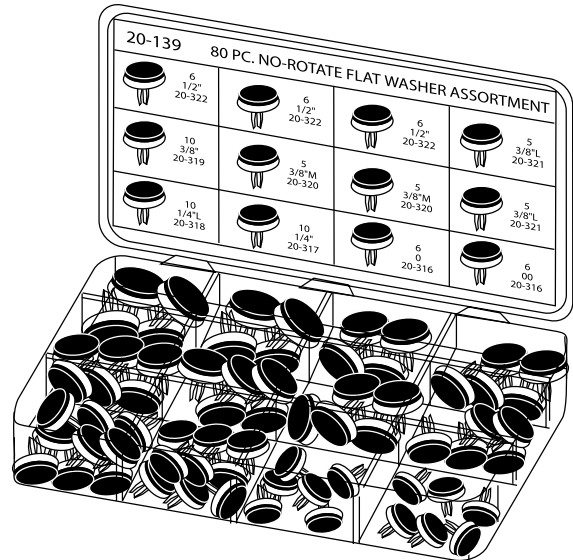

- 80 no-rotate seat washer assortment
- Illustration chart in lid

20-139 "No-Rotate" Seat Washer Assortment Kit **88.52**

JUMBO SEAT WASHER KIT

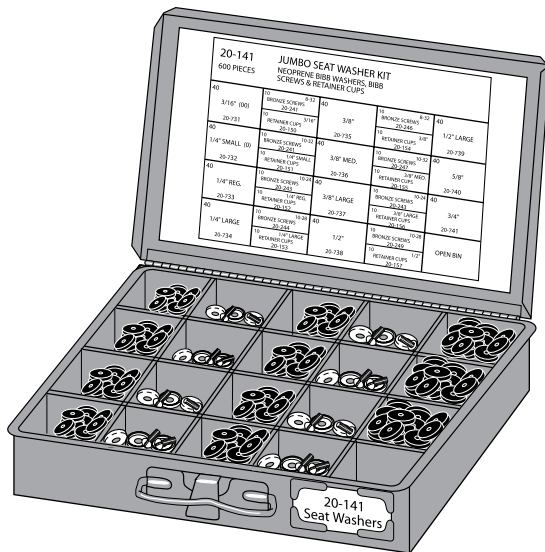

- 500 piece assortment kit includes: neoprene bibb washers, bibb screws & retainer cups
- Illustration chart in lid
- Also included in 20-145 parts cabinet on this page

20-141 600 Pc. Faucet Seat Washer Assortment Kits **212.53**

COMPLETE FAUCET REPAIR CENTER

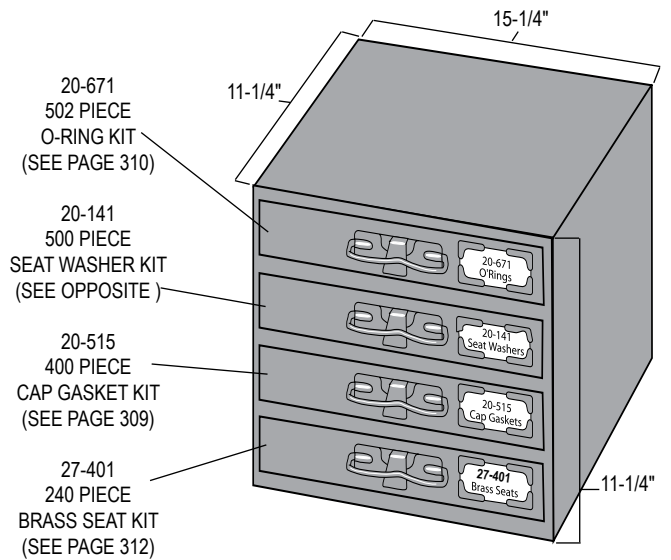

- 1642 total items
- Illustration charts in lid
- Heavy gauge steel parts cabinet with sliding drawers

20-145 Complete Faucet Repair Center **709.77**

USE YOUR CREDIT CARD AT TIME OF PURCHASE AND SAVE 2% ON ALL ORDERS, SAVE 5% ON ALL ORDERS OVER \$500 OR SAVE 10% ON ALL ORDERS OVER \$1000

FAX 1-800-982-5934 www.HODES CO.com PHONE 1-800-777-6500



INTERNAL FAUCET REPAIR



BRASS FAUCETS SEATS

For AMERICAN BRASS

(174-14)

(1848-07)

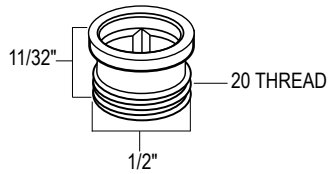

*Not Available From American Brass

SOLD 2 PER PACKAGE ONLY

27-417 *Generic Brass Faucet Seat **.81¢**

For AMERICAN STANDARD

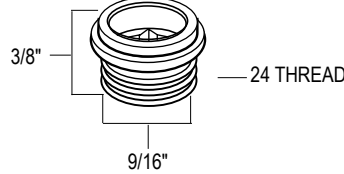

*Not Available From American Standard

"B" SERIES

SOLD 10 PER PACKAGE ONLY

27-300 *Generic Brass Faucet Seat **.53¢**

For AMERICAN STANDARD

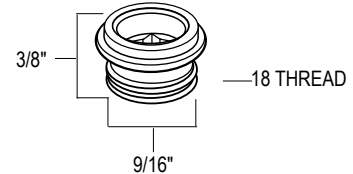

*Not Available From American Standard

SOLD 10 PER PACKAGE ONLY

27-302 *Generic Brass Faucet Seat **.46¢**

For AMERICAN STANDARD (SCHAIBLE)

LAVATORY, KITCHEN, TUB & SHOWER

(862-14)

(57281-07)

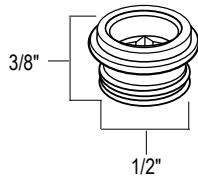

SOLD 10 PER PACKAGE ONLY

27-310 *Generic Brass Faucet Seat **.53¢**

For AMERICAN STANDARD

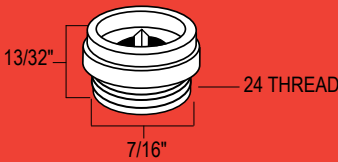

*Not Available From American Standard

AQUASEAL

SOLD 10 PER PACKAGE ONLY

27-380 *Generic Brass Faucet Seat **.41¢**
27-381 *Generic Monel Faucet Seat **3.53**

For AMERICAN STANDARD

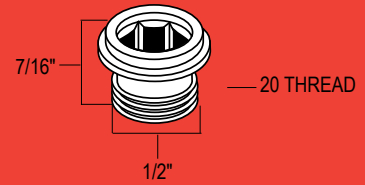

COLONY

SOLD 10 PER PACKAGE ONLY

27-382 *Generic Brass Faucet Seat **.41¢**

For AMERICAN STANDARD

(44257-04)

For AMERICAN STANDARD

(13274-04)

For AMERICAN STANDARD

(12002-07)

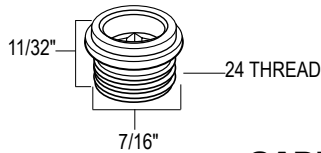

CADET NU-SEAL

SOLD 10 PER PACKAGE ONLY

27-536 *Generic Brass Faucet Seat **.71¢**

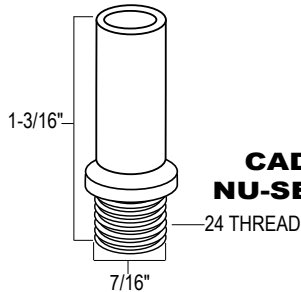

CADET NU-SEAL

SOLD 2 PER PACKAGE ONLY

27-535 *Generic Brass Faucet Seat **1.10**

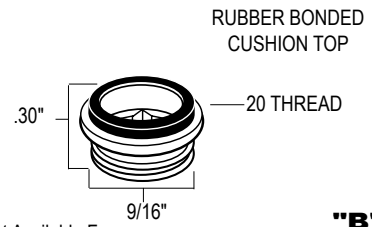

RUBBER BONDED CUSHION TOP

"B" SERIES

*Not Available From American Standard

SOLD 2 PER PACKAGE ONLY

27-414 *Generic Brass Faucet Seat **1.61**

For BARNES (ELJER)

(7192)

For CENTRAL

(263)

For CENTRAL

(165)

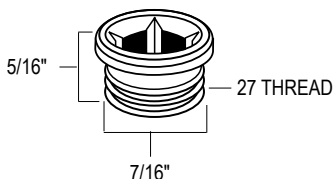

*Not Available From Barnes

SOLD 2 PER PACKAGE ONLY

27-429 *Generic Brass Faucet Seat **1.32**

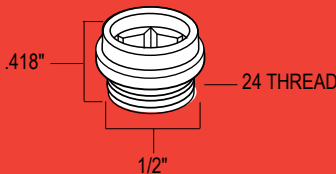

SOLD 10 PER PACKAGE ONLY

27-354 Generic Brass Faucet Seat **.41¢**
27-355 Generic Monel Faucet Seat **3.53**

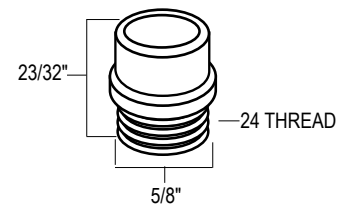

SOLD 10 PER PACKAGE ONLY

27-344 Generic Brass Faucet Seat **.76¢**

USE YOUR CREDIT CARD AT TIME OF PURCHASE AND SAVE 2% ON ALL ORDERS, SAVE 5% ON ALL ORDERS OVER \$500 OR SAVE 10% ON ALL ORDERS OVER \$1000

1-800-982-5934 FAX **www.HODES CO.com** PHONE **1-800-777-6500**
314 **PROFERRED PLUMBING PRODUCTS**

FAUCET SEATS

BRASS FAUCET SEATS



INTERNAL FAUCET REPAIR

For CRANE

(F14301)

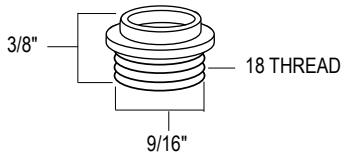

*Not Available From Crane

SOLD 10 PER PACKAGE ONLY

27-312 *Generic Brass Faucet Seat **.71¢**

For ELJER

(5257)

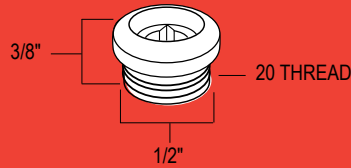

SOLD 10 PER PACKAGE ONLY

27-452 Generic Brass Faucet Seat **.41¢**

For ELJER

(4703)

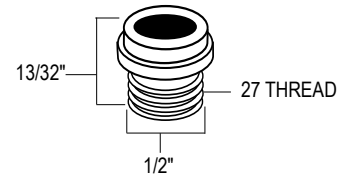

SOLD 10 PER PACKAGE ONLY

27-348 Generic Brass Faucet Seat **.71¢**

For ELJER

(2934)

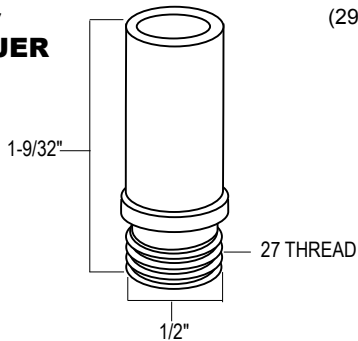

SOLD 2 PER PACKAGE ONLY

27-451 Generic Brass Faucet Seat **1.14**

For GERBER

(16)

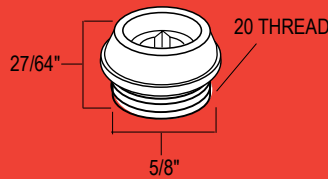

SOLD 10 PER PACKAGE ONLY

27-386 Generic Brass Faucet Seat **.41¢**
27-586 Generic Monel Faucet Seat **4.61**

GERBER

(16)

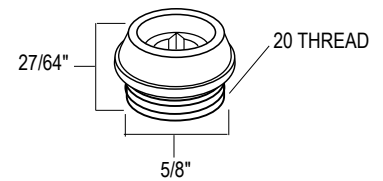

SOLD 10 PER PACKAGE ONLY

27-387 Genuine Brass Faucet Seat **1.17**

GENUINE COMPARE

For HARCRAFT

(6311)

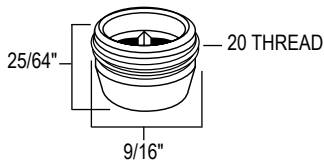

*Not Available From Harcraft

SOLD 10 PER PACKAGE ONLY

27-396 *Generic Brass Faucet Seat **.53¢**

For INDIANA BRASS

(590-0)

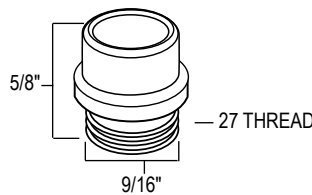

SOLD 10 PER PACKAGE ONLY

27-509 Generic Brass Faucet Seat **.71¢**

For KOHLER

(40602)

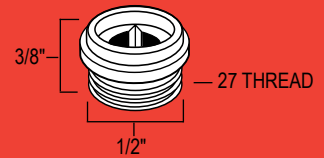

SOLD 10 PER PACKAGE ONLY

27-560 Generic Brass Faucet Seat **.41¢**

For KOHLER

(20774)

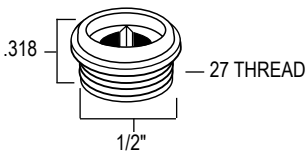

SOLD 10 PER PACKAGE ONLY

27-306 Generic Brass Faucet Seat **.53¢**

For KOHLER

(23004)

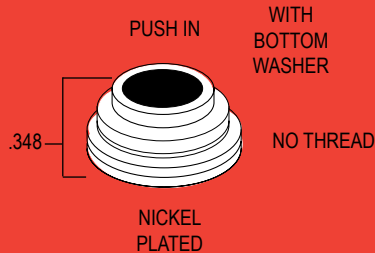

SOLD 2 PER PACKAGE ONLY

27-394 Generic Brass Faucet Seat **.71¢**

For KOHLER

(33345)

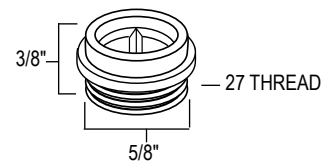

SOLD 10 PER PACKAGE ONLY

27-304 Generic Brass Faucet Seat **.53¢**

USE YOUR CREDIT CARD AT TIME OF PURCHASE AND SAVE 2% ON ALL ORDERS, SAVE 5% ON ALL ORDERS OVER \$500 OR SAVE 10% ON ALL ORDERS OVER \$1000

FAX 1-800-982-5934

www.HODES CO.com

PHONE 1-800-777-6500
315

FAUCET SEATS

INTERNAL FAUCET REPAIR



BRASS FAUCET SEATS

For MILWAUKEE

(964)

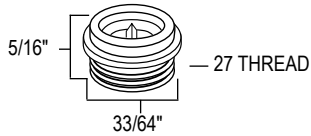

*Not Available From Milwaukee

SOLD 10 PER PACKAGE ONLY

27-368 *Generic Brass Faucet Seat **.71¢**

For MILWAUKEE

(3169)

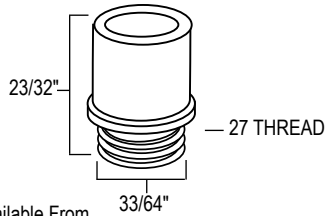

*Not Available From Milwaukee

SOLD 5 PER PACKAGE ONLY

27-470 *Generic Brass Faucet Seat **.94¢**

For PRICE PFISTER

(972-730)

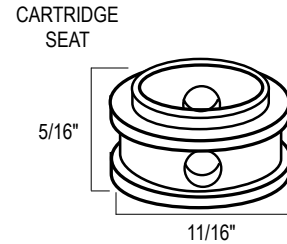

SOLD 10 PER PACKAGE ONLY

27-336 Generic Brass Faucet Seat **.71¢**

For PRICE PFISTER

(970-510)

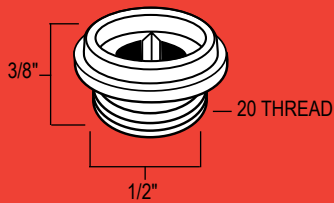

SOLD 10 PER PACKAGE ONLY

27-340 Generic Brass Faucet Seat **.41¢**
27-341 Generic Monel Faucet Seat **3.34**

For PRICE PFISTER

(970-500)

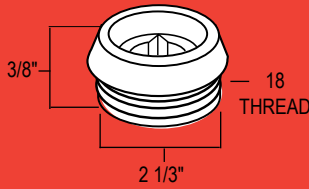

SOLD 10 PER PACKAGE ONLY

27-338 Generic Brass Faucet Seat **.54¢**
27-554 Generic Monel Faucet Seat **5.37**

PRICE PFISTER

(970-500)

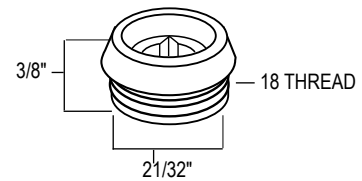

SOLD 6 PER PACKAGE ONLY

27-679 Genuine Brass Faucet Seat **.94¢**

For SAYCO

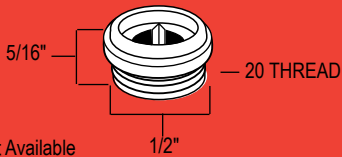

*Not Available From Sayco

SOLD 10 PER PACKAGE ONLY

27-372 *Generic Brass Faucet Seat **.41¢**
27-373 *Generic Monel Faucet Seat **3.50**

For SAYCO

(OLD6F)

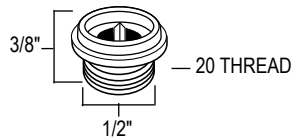

*Not Available From Sayco

SOLD 10 PER PACKAGE ONLY

27-666 *Generic Brass Faucet Seat **.53¢**

For SAYCO

(056)

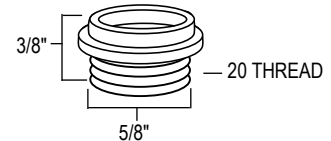

*Not Available From Sayco

SOLD 10 PER PACKAGE ONLY

27-476 *Generic Brass Faucet Seat **.71¢**

For SCHIABLE (AMERICAN STANDARD)

(56534-07)

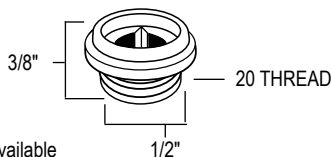

*Not Available From Schiable

SOLD 10 PER PACKAGE ONLY

27-310 *Generic Brass Faucet Seat **.53¢**
27-311 *Generic Monel Faucet Seat **3.50**

For SEARS (UNIVERSAL RUNDLE)

(R-12)

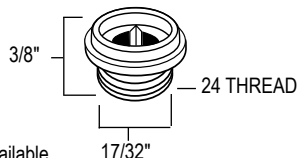

*Not Available From Sears

SOLD 10 PER PACKAGE ONLY

27-370 *Generic Brass Faucet Seat **.53¢**

For SPEAKMAN

(05-0775)

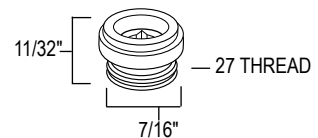

SOLD 10 PER PACKAGE ONLY

27-374 Generic Brass Faucet Seat **.53¢**

FAUCET SEATS

USE YOUR CREDIT CARD AT TIME OF PURCHASE AND SAVE 2% ON ALL ORDERS, SAVE 5% ON ALL ORDERS OVER \$500 OR SAVE 10% ON ALL ORDERS OVER \$1000

FAX 1-800-982-5934 www.HODESCO.com PHONE 1-800-777-6500
316



BRASS AND MONEL FAUCET SEATS



INTERNAL FAUCET REPAIR

For STERLING FAUCET (99S0369)

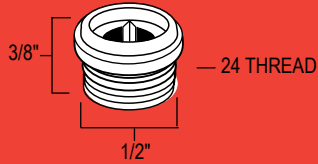

SOLD 10 PER PACKAGE ONLY

27-342 Generic Brass Faucet Seat **.41¢**
 27-343 Generic Monel Faucet Seat **3.50**

For STREAMWAY (95025)

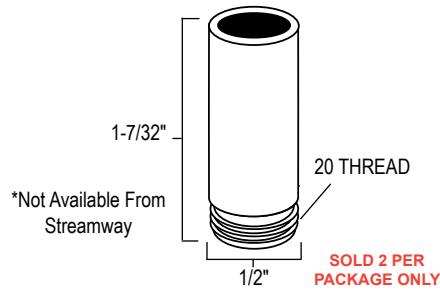

SOLD 2 PER PACKAGE ONLY

27-407 *Generic Brass Faucet Seat **1.04**

For STREAMWAY (980-20)

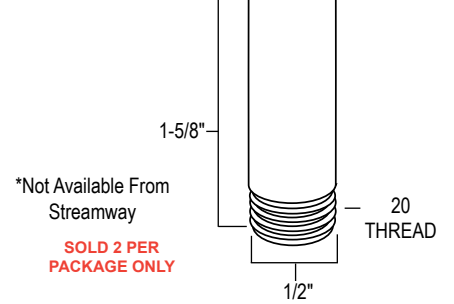

SOLD 2 PER PACKAGE ONLY

27-409 *Generic Brass Faucet Seat **1.53**

For UNION BRASS (2601)

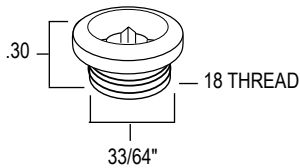

SOLD 10 PER PACKAGE ONLY

27-324 Generic Brass Faucet Seat **.53¢**

For UNION BRASS (2632)

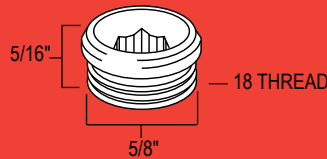

SOLD 10 PER PACKAGE ONLY

27-388 Generic Brass Faucet Seat **.54¢**

For UNION BRASS (2634)

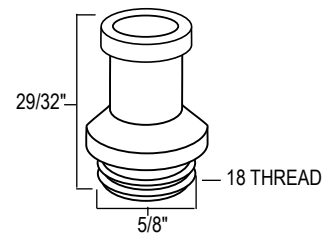

SOLD 2 PER PACKAGE ONLY

27-489 Generic Brass Faucet Seat **.94¢**

For UNION BRASS (2635)

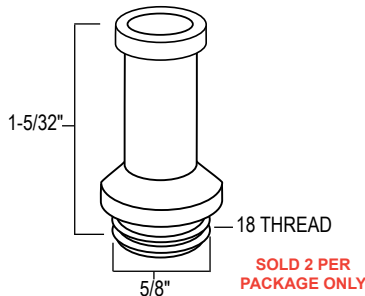

SOLD 2 PER PACKAGE ONLY

27-490 Generic Brass Faucet Seat **1.17**

For UNIVERSAL RUNDLE (P692)

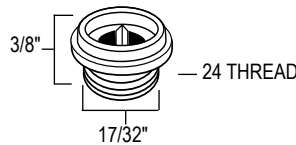

*Not Available From Universal Rundle

SOLD 10 PER PACKAGE ONLY

27-370 *Generic Brass Faucet Seat **.53¢**

For WOLVERINE (586-S)

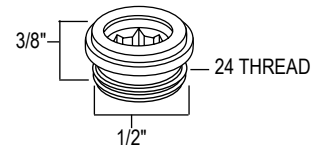

SOLD 10 PER PACKAGE ONLY

27-494 Generic Brass Faucet Seat **.53¢**

For BRIGGS

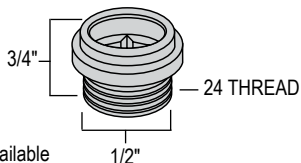

*Not Available From Briggs

SOLD 2 PER PACKAGE ONLY

27-327 *Generic Monel Faucet Seat **3.50**

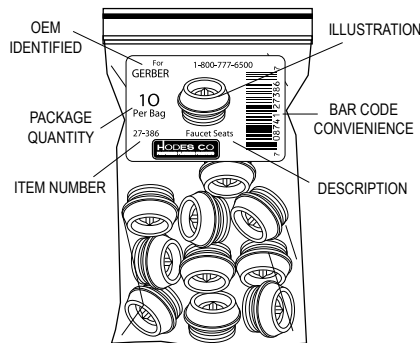

THERE IS A DIFFERENCE.™



(1-27)

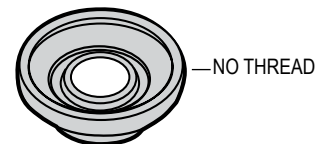

QUATURN

SOLD 2 PER PACKAGE ONLY

21-102 Genuine Monel Faucet Seat **1.33**

USE YOUR CREDIT CARD AT TIME OF PURCHASE AND SAVE 2% ON ALL ORDERS, SAVE 5% ON ALL ORDERS OVER \$500 OR SAVE 10% ON ALL ORDERS OVER \$1000

FAX 1-800-982-5934 www.HODESCO.com PHONE 1-800-777-6500



INTERNAL FAUCET REPAIR



BRASS BIBB SCREWS

3/8" HGT. X 6-32 THREAD

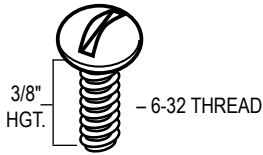

SOLD 25 PER PACKAGE ONLY

- 20-240 Brass Bibb Screw **.23¢**
- 20-270 Monel Self Locking Bibb Screw **.40¢**

3/8" HGT. X 8-32 THREAD

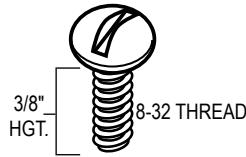

SOLD IN PACKAGE QUANTITY ONLY

- | | | |
|--------------------------------------|------------|-------------|
| | PKG
QTY | |
| 20-241 Brass Bibb Screw | (25) | .23¢ |
| 20-258 Chromed Brass Bibb Screw | (10) | .35¢ |
| 20-272 Monel Self Locking Bibb Screw | (10) | .40¢ |

3/8" HGT. X 10-24 THREAD

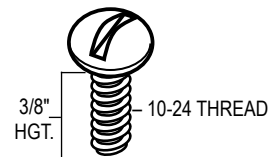

SOLD IN PACKAGE QUANTITY ONLY

- | | | |
|--------------------------------------|------------|-------------|
| | PKG
QTY | |
| 20-243 Brass Bibb Screw | (25) | .23¢ |
| 20-260 Chromed Brass Bibb Screw | (10) | .35¢ |
| 20-265 Monel Self Locking Bibb Screw | (10) | .40¢ |

3/8" HGT. X 10-28 THREAD

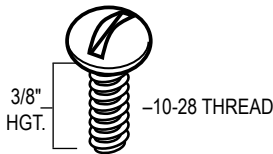

SOLD 25 PER PACKAGE ONLY

- 20-244 Brass Bibb Screw **.23¢**

3/8" HGT. X 10-32 THREAD

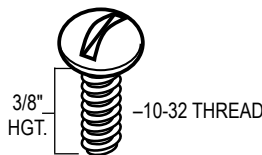

SOLD IN PACKAGE QUANTITY ONLY

- | | | |
|---------------------------------|------------|-------------|
| | PKG
QTY | |
| 20-242 Brass Bibb Screw | (25) | .23¢ |
| 20-263 Chromed Brass Bibb Screw | (10) | .35¢ |

1/2" HGT. X 6-32 THREAD

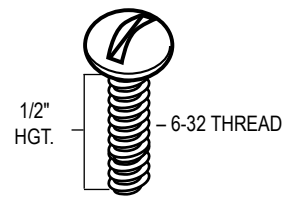

SOLD IN PACKAGE QUANTITY ONLY

- | | | |
|---------------------------------|------------|-------------|
| | PKG
QTY | |
| 20-245 Brass Bibb Screw | (25) | .23¢ |
| 20-264 Chromed Brass Bibb Screw | (10) | .35¢ |

1/2" HGT. X 8-32 THREAD

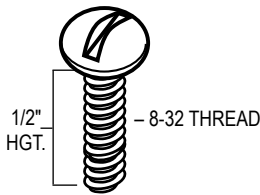

SOLD IN PACKAGE QUANTITY ONLY

- | | | |
|---------------------------------|------------|-------------|
| | PKG
QTY | |
| 20-246 Brass Bibb Screw | (25) | .23¢ |
| 20-266 Chromed Brass Bibb Screw | (10) | .35¢ |

1/2" HGT. X 10-24 THREAD

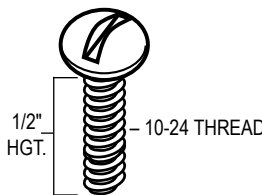

SOLD IN PACKAGE QUANTITY ONLY

- | | | |
|---------------------------------|------------|-------------|
| | PKG
QTY | |
| 20-248 Brass Bibb Screw | (25) | .23¢ |
| 20-261 Chromed Brass Bibb Screw | (10) | .35¢ |

1/2" HGT. X 10-28 THREAD

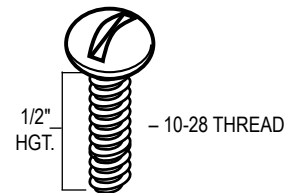

SOLD 25 PER PACKAGE ONLY

- 20-249 Brass Bibb Screw **.23¢**

1/2" HGT X 10-32 THREAD

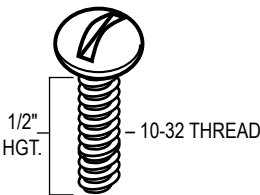

SOLD 25 PER PACKAGE ONLY

- 20-268 Chromed Brass Bibb Screw **.35¢**

BRASS BIBB SCREWS

• SEE Other
Boxed Repair Kits
on Page 308-313



- 300 Assorted Brass Bibb Screws
- 10 different sizes

- 20-953 Repair Kit **47.01**

TEE HANDLE TAP

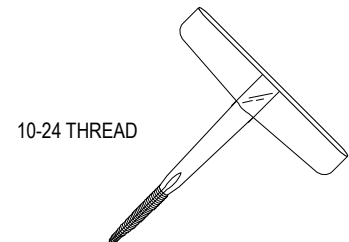

- 20-254 Handle Tap **6.63**

BIBB SCREWS

USE YOUR CREDIT CARD AT TIME OF PURCHASE AND SAVE 2% ON ALL ORDERS, SAVE 5% ON ALL ORDERS OVER \$500 OR SAVE 10% ON ALL ORDERS OVER \$1000

FAX 1-800-982-5934 www.HODES CO.com PHONE 1-800-777-6500
318



MULTI-COLORED BUNA-N BIBB WASHERS



INTERNAL FAUCET REPAIR

1/4" SMALL (OO) BUNA-N FLAT BIBB WASHER (GREY)

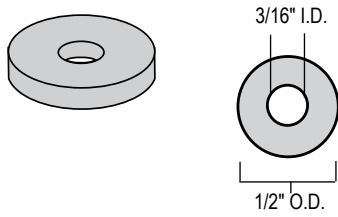

SOLD 50 PER PACKAGE ONLY

20-731 Flat Bibb Washer **.15¢**

1/4" MEDIUM (0) BUNA-N FLAT BIBB WASHER (RED)

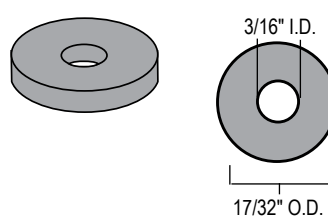

SOLD 50 PER PACKAGE ONLY

20-732 Flat Bibb Washer **.15¢**

1/4" BUNA-N FLAT BIBB WASHER (GREEN)

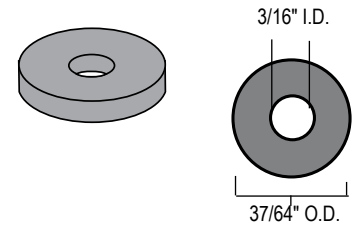

SOLD 50 PER PACKAGE ONLY

20-733 Flat Bibb Washer **.15¢**

1/4" LARGE BUNA-N FLAT BIBB WASHER (BLUE)

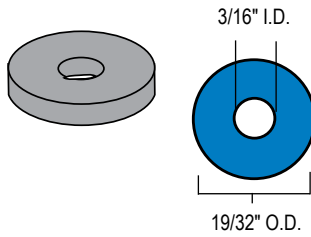

SOLD 50 PER PACKAGE ONLY

20-734 Flat Bibb Washer **.15¢**

3/8" BUNA-N FLAT BIBB WASHER (ORANGE)

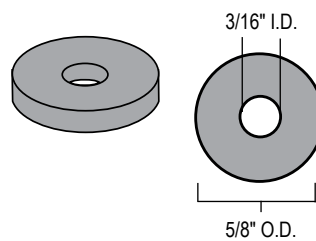

SOLD 50 PER PACKAGE ONLY

20-735 Flat Bibb Washer **.15¢**

3/8" MEDIUM BUNA-N FLAT BIBB WASHER (BLACK)

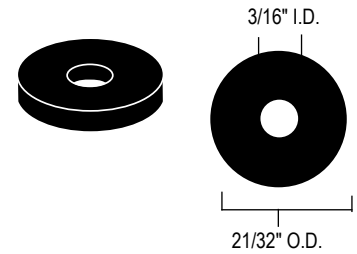

SOLD 50 PER PACKAGE ONLY

20-736 Flat Bibb Washer **.15¢**

3/8" LARGE BUNA-N FLAT BIBB WASHER (PURPLE)

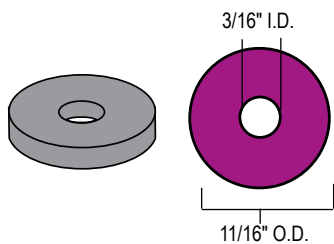

SOLD 50 PER PACKAGE ONLY

20-737 Flat Bibb Washer **.15¢**

1/2" BUNA-N FLAT BIBB WASHER (YELLOW)

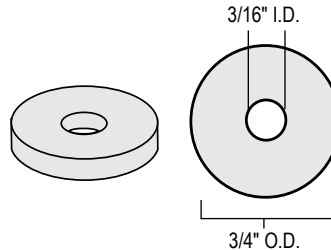

SOLD 50 PER PACKAGE ONLY

20-738 1/2" Flat Bibb Washer **.15¢**

5/8" BUNA-N FLAT BIBB WASHER (BLACK)

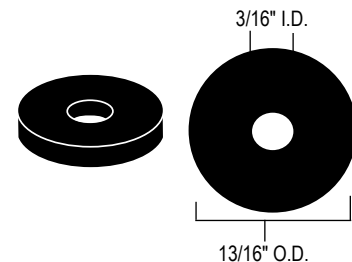

SOLD 50 PER PACKAGE ONLY

20-740 Flat Bibb Washer **.15¢**

USE YOUR CREDIT CARD AT TIME OF PURCHASE AND SAVE 2% ON ALL ORDERS, SAVE 5% ON ALL ORDERS OVER \$500 OR SAVE 10% ON ALL ORDERS OVER \$1000

FAX 1-800-982-5934

www.HODESCO.com



PHONE 1-800-777-6500

INTERNAL FAUCET REPAIR



MULTI-COLORED BUNA-N BEVELED BIB WASHERS

1/4" SMALL (00) BUNA-N BEVELED BIB WASHER

(GREY)

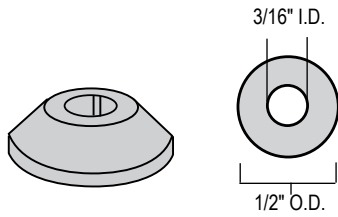

SOLD 50 PER PACKAGE ONLY

20-751 Beveled Bib Washer **.17¢**

1/4" MEDIUM (0) BUNA-N BEVELED BIB WASHER

(RED)

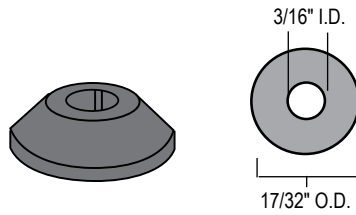

SOLD 50 PER PACKAGE ONLY

20-752 Beveled Bib Washer **.17¢**

1/4" BUNA-N BEVELED BIB WASHER

(GREEN)

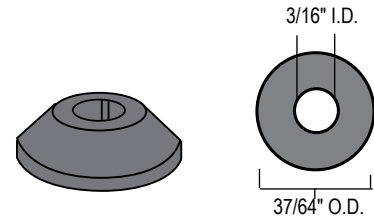

SOLD 50 PER PACKAGE ONLY

20-753 Beveled Bib Washer **.17¢**

1/4" LARGE BUNA-N BEVELED BIB WASHER

(BLUE)

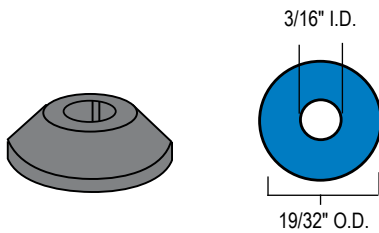

SOLD 50 PER PACKAGE ONLY

20-754 Beveled Bib Washer **.17¢**

3/8" BUNA-N BEVELED BIB WASHER

(ORANGE)

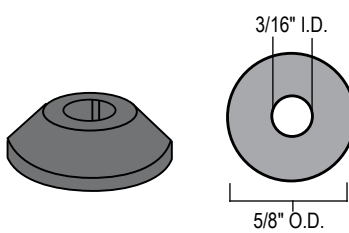

SOLD 50 PER PACKAGE ONLY

20-755 Beveled Bib Washer **.17¢**

3/8" MEDIUM BUNA-N BEVELED BIB WASHER

(BLACK)

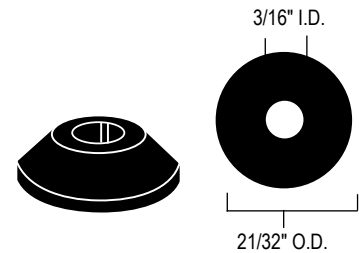

SOLD 50 PER PACKAGE ONLY

20-756 Beveled Bib Washer **.17¢**

3/8" LARGE BUNA-N BEVELED BIB WASHER

(PURPLE)

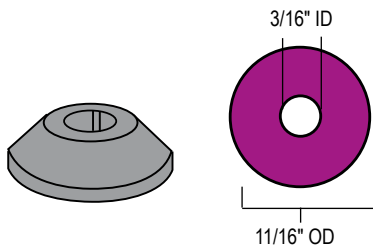

SOLD 50 PER PACKAGE ONLY

20-757 Beveled Bib Washer **.17¢**

1/2" BUNA-N BEVELED BIB WASHER

(YELLOW)

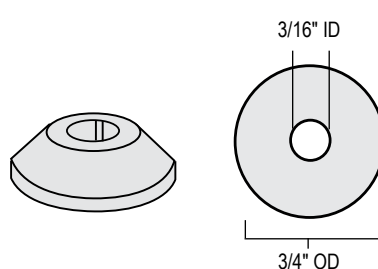

SOLD 50 PER PACKAGE ONLY

20-758 Beveled Bib Washer **.17¢**

1" BUNA-N BEVELED BIB WASHER

(BLACK)

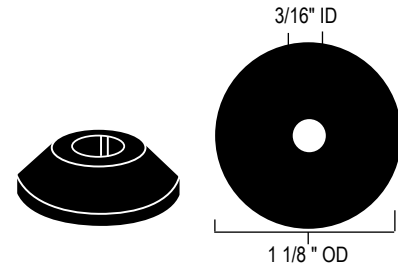

SOLD 50 PER PACKAGE ONLY

20-762 Beveled Bib Washer **.17¢**

BIB WASHERS

USE YOUR CREDIT CARD AT TIME OF PURCHASE AND SAVE 2% ON ALL ORDERS, SAVE 5% ON ALL ORDERS OVER \$500 OR SAVE 10% ON ALL ORDERS OVER \$1000

1-800-982-5934 FAX **www.HODES CO.com** PHONE **1-800-777-6500**
 320 **PROFERRED PLUMBING PRODUCTS**

BIBB WASHER CUPS



**INTERNAL FAUCET
REPAIR**

SERVING THE QUALITY
MINDED PLUMBING
CONTRACTORS OF
AMERICA SINCE 1943.

OUR TRADEMARKS:
EXCEPTIONAL SERVICE,
EXCEPTIONAL QUALITY.

(OO) BRASS RETAINER CUP

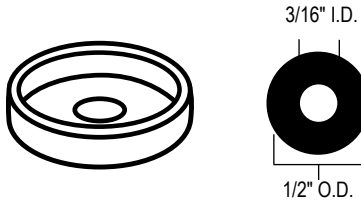

SOLD 10 PER PACKAGE ONLY

20-150 Brass Retainer Cup **.53¢**

1/4" SMALL(O) BRASS RETAINER CUP

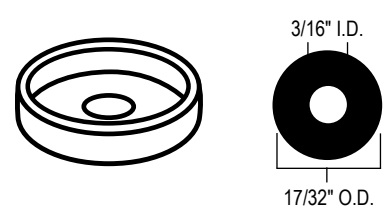

SOLD 10 PER PACKAGE ONLY

20-151 Brass Retainer Cup **.53¢**

1/4" MEDIUM BRASS RETAINER CUP

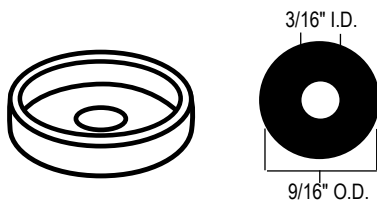

SOLD 10 PER PACKAGE ONLY

20-152 Brass Retainer Cup **.53¢**

1/4" LARGE BRASS RETAINER CUP

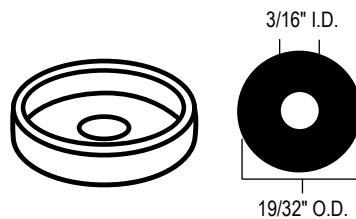

SOLD 10 PER PACKAGE ONLY

20-153 Brass Retainer Cup **.53¢**



(1-022)

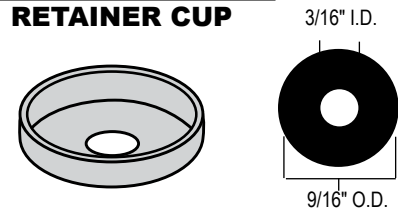

MONEL

SOLD 6 PER PACKAGE ONLY

21-103 Genuine Monel Cup **1.77**

3/8" BRASS RETAINER CUP

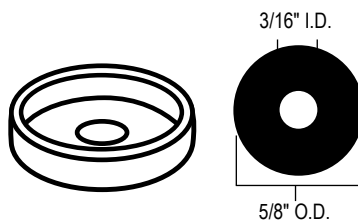

SOLD 10 PER PACKAGE ONLY

20-154 Brass Retainer Cup **.53¢**

3/8" MEDIUM BRASS RETAINER CUP

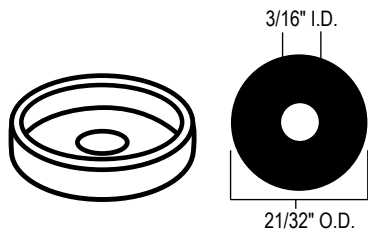

SOLD 10 PER PACKAGE ONLY

20-155 Brass Retainer Cup **.53¢**

3/8" LARGE BRASS RETAINER CUP

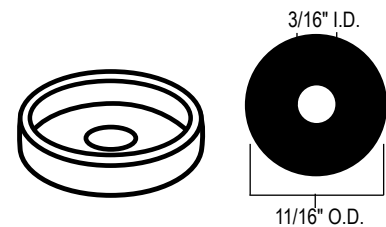

SOLD 10 PER PACKAGE ONLY

20-156 Brass Retainer Cup **.53¢**

1/2" BRASS RETAINER CUP

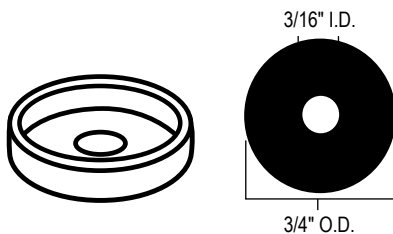

SOLD 10 PER PACKAGE ONLY

20-157 Brass Retainer Cup **.53¢**

1/2" LARGE BRASS RETAINER CUP

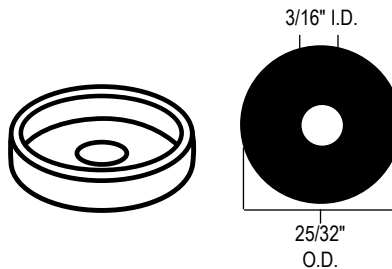

SOLD 10 PER PACKAGE ONLY

20-159 Brass Retainer Cup **.53¢**

BRASS BIBB RETAINER CUP ASSORTMENT

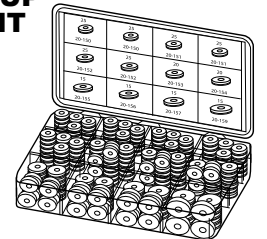

- 250 assorted brass bibb retainers
- Illustration chart in lid
- 9 popular sizes

20-173 Brass Bibb Retainer Assort. Kit .. **100.38**

**USE YOUR CREDIT CARD AT TIME OF PURCHASE AND SAVE 2% ON ALL ORDERS,
SAVE 5% ON ALL ORDERS OVER \$500 OR SAVE 10% ON ALL ORDERS OVER \$1000**

**FAX
1-800-982-5934**

www.HODES CO.com
PROFFERED PLUMBING PRODUCTS

**PHONE
1-800-777-6500
321**

BIBB WASHER CUPS

INTERNAL FAUCET REPAIR



CAP GASKETS

15/16"O.D. x 13/16" I.D. x 1/16"HGT.

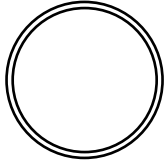

For Central, Indiana, Sterling, etc.

PLASTIC

SOLD 10 PER PACKAGE ONLY

20-483 Cap Gasket **.28¢**

7/8"O.D. x 11/16" I.D. x 1/16"HGT.

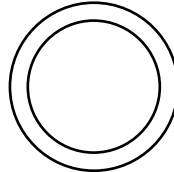

For Eljer, etc.

PLASTIC

SOLD 10 PER PACKAGE ONLY

20-478 Cap Gasket **.28¢**

7/8"O.D. x 3/4" I.D. x 1/16"HGT.

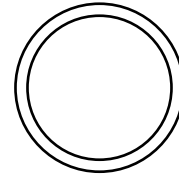

For Price Pfister, Kohler, Central, Royal, Gerber

PLASTIC

SOLD 10 PER PACKAGE ONLY

20-442 Cap Gasket **.28¢**

29/32"O.D. x 13/16" I.D. x 1/16"HGT.

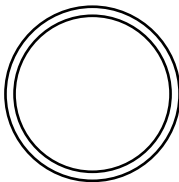

For various

RUBBER

SOLD 10 PER PACKAGE ONLY

20-471 Cap Gasket **.28¢**

15/16"O.D. x 27/32" I.D. x 1/16"HGT.

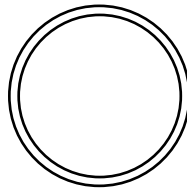

For Central, Indiana, Sterling, etc.

PLASTIC

SOLD 10 PER PACKAGE ONLY

20-463 Cap Gasket **.28¢**



(1-43)

1"O.D. x 13/16" I.D. x 3/32"HGT.

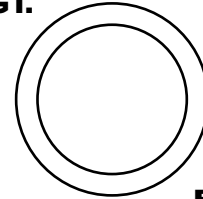

RUBBER

SOLD 10 PER PACKAGE ONLY

21-097 Genuine Cap Gasket **1.05**

1-1/16"O.D. x 7/8" I.D. x 1/16"HGT.

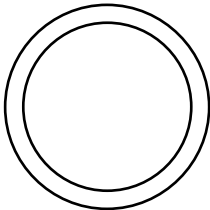

For Price Pfister, Gerber, etc.

PLASTIC

SOLD 10 PER PACKAGE ONLY

20-430 Cap Gasket **.28¢**

1-1/32"O.D. x 15/16" I.D. x 1/16"HGT.

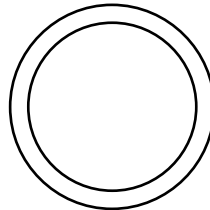

For Sterling, etc.

PLASTIC

SOLD 10 PER PACKAGE ONLY

20-460 Cap Gasket **.28¢**

1-3/32"O.D. x 13/16" I.D. x 1/8"HGT.

Rubber insulated cork

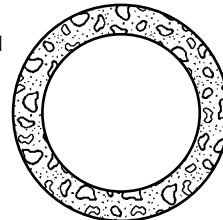

For Crane

CORK

SOLD 10 PER PACKAGE ONLY

21-125 Cap Gasket **.35¢**

1-3/16"O.D. x 1" I.D. x 1/16"HGT.

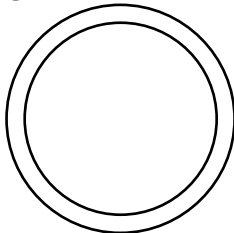

For Central, American Standard

PLASTIC

SOLD 10 PER PACKAGE ONLY

20-440 Cap Gasket **.28¢**

1-1/4"O.D. x 1-1/16" I.D. x 1/16"HGT.

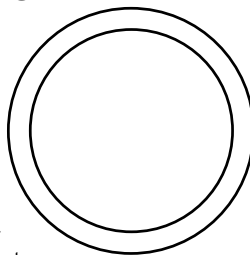

For Gerber, etc.

FIBER

SOLD 10 PER PACKAGE ONLY

20-434 Cap Gasket **.28¢**

CAP GASKETS

LAVATORY, KITCHEN TUB & SHOWER

SEE Other Boxed Repair Kits on Page 308 - 313

150 ASSORTED CAP THREAD GASKETS

12 POPULAR SIZES

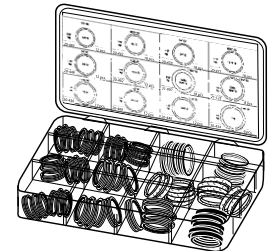

20-517 150 Pc. Cap Gasket Kit **31.76**

CAP GASKETS

USE YOUR CREDIT CARD AT TIME OF PURCHASE AND SAVE 2% ON ALL ORDERS, SAVE 5% ON ALL ORDERS OVER \$500 OR SAVE 10% ON ALL ORDERS OVER \$1000

1-800-982-5934 FAX **www.HODES CO.com** PHONE **1-800-777-6500**
322



BUNA-N O'RINGS



INTERNAL FAUCET REPAIR

HONOR THY PLUMBER™

1/4"O.D. x 1/8" I.D. (-006)
x 1/16" HGT.



SOLD 25 PER PACKAGE ONLY

20-602 O'Ring **.17¢**

9/32"O.D. x 5/32" I.D. (-007)
x 1/16" HGT.



SOLD 25 PER PACKAGE ONLY

20-603 O'Ring **.17¢**

11/32"O.D. x 7/32" I.D. (-009)
x 1/16" HGT.



SOLD 25 PER PACKAGE ONLY

20-604 O'Ring **.17¢**

3/8"O.D. x 1/4" I.D. (-010)
x 1/16" HGT.



SOLD 25 PER PACKAGE ONLY

20-202 O'Ring **.17¢**

7/16"O.D. x 5/16" I.D. (-011)
x 1/16" HGT.



SOLD 25 PER PACKAGE ONLY

20-203 O'Ring **.17¢**

7/16"O.D. x 1/4" I.D. (-108)
x 1/8" HGT.



SOLD 25 PER PACKAGE ONLY

20-605 O'Ring **.17¢**

1/2"O.D. x 3/8" I.D. (-012)
x 1/16" HGT.



SOLD 25 PER PACKAGE ONLY

20-205 O'Ring **.17¢**

1/2"O.D. x 1/4" I.D. (-202)
x 1/8" HGT.



SOLD 25 PER PACKAGE ONLY

20-606 O'Ring **.17¢**

1/2"O.D. x 5/16" I.D. (-109)
x 3/32" HGT.



SOLD 25 PER PACKAGE ONLY

20-607 O'Ring **.17¢**

9/16"O.D. x 5/16" I.D. (-203)
x 1/8" HGT.



SOLD 25 PER PACKAGE ONLY

20-224 O'Ring **.17¢**

BUNA-N O'RING KIT

200 pieces

12 different sizes

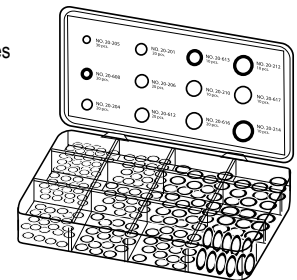

20-234 200 Pc. O'Ring Assortment Kit **12.96**

USE YOUR CREDIT CARD AT TIME OF PURCHASE AND SAVE 2% ON ALL ORDERS, SAVE 5% ON ALL ORDERS OVER \$500 OR SAVE 10% ON ALL ORDERS OVER \$1000

FAX 1-800-982-5934

www.HODES CO.com
PROFERRED PLUMBING PRODUCTS

PHONE 1-800-777-6500
323

O'RINGS

INTERNAL FAUCET REPAIR



BUNA-N O'RINGS

**9/16"O.D. x 7/16" I.D.
x 1/16"HGT.**

(-013)

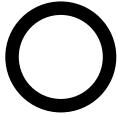

SOLD 25 PER PACKAGE ONLY

20-609 O'Ring **.23¢**

**9/16"O.D. x 3/8" I.D.
x 3/32"HGT.**

(-110)

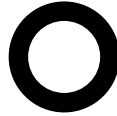

SOLD 25 PER PACKAGE ONLY

20-204 O'Ring **.23¢**

**5/8"O.D. x 1/2" I.D.
x 1/16"HGT.**

(-014)

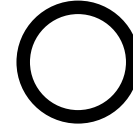

SOLD 25 PER PACKAGE ONLY

20-201 O'Ring **.23¢**

**5/8"O.D. x 7/16" I.D.
x 3/32"HGT.**

(-111)



SOLD 25 PER PACKAGE ONLY

20-206 O'Ring **.23¢**

**5/8"O.D. x 3/8" I.D.
x 1/8"HGT.**

(-204)



SOLD 25 PER PACKAGE ONLY

20-610 O'Ring **.23¢**

**11/16"O.D. x 7/16" I.D.
x 1/8"HGT.**

(-205)

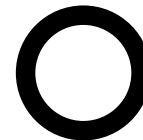

SOLD 25 PER PACKAGE ONLY

20-207 O'Ring **.23¢**

**11/16"O.D. x 1/2" I.D.
x 3/32"HGT.**

(-112)

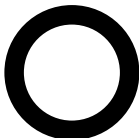

SOLD 25 PER PACKAGE ONLY

20-208 O'Ring **.23¢**

**11/16"O.D. x 9/16" I.D.
x 1/16"HGT.**

(-015)

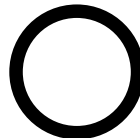

SOLD 25 PER PACKAGE ONLY

20-612 O'Ring **.23¢**

O'RING PIK



20-675 O'Ring / Washer Pik **3.06**

O'RINGS

**USE YOUR CREDIT CARD AT TIME OF PURCHASE AND SAVE 2% ON ALL ORDERS,
SAVE 5% ON ALL ORDERS OVER \$500 OR SAVE 10% ON ALL ORDERS OVER \$1000**

**FAX
1-800-982-5934**

www.



.com

**PHONE
1-800-777-6500**

BUNA-N O'RINGS

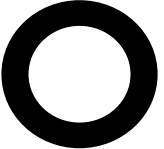
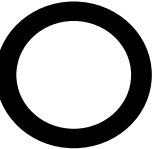
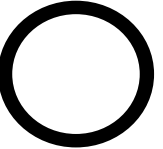
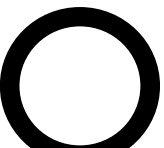
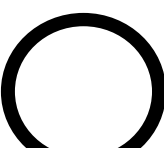
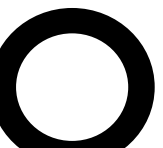
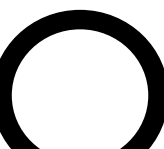
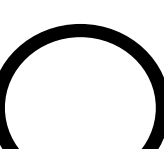
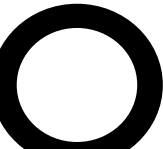
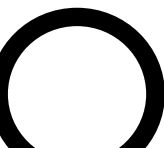
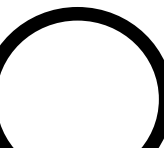
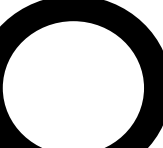

INTERNAL FAUCET REPAIR

<p>3/4"O.D. X 1/2" I.D. X 1/8" HGT. (-206)</p>  <p>SOLD 25 PER PACKAGE ONLY</p> <p>20-615 O'Ring28¢</p>	<p>3/4"O.D. x 9/16" I.D. x 3/32" HGT. (-113)</p>  <p>SOLD 25 PER PACKAGE ONLY</p> <p>20-210 O'Ring28¢</p>	<p>3/4"O.D. x 5/8" I.D. x 1/16" HGT. (-016)</p>  <p>SOLD 25 PER PACKAGE ONLY</p> <p>20-616 O'Ring28¢</p>
<p>13/16"O.D. x 5/8" I.D. x 3/32" HGT. (-114)</p>  <p>SOLD 25 PER PACKAGE ONLY</p> <p>20-212 O'Ring28¢</p>	<p>13/16"O.D. x 11/16" I.D. x 1/16" HGT. (-017)</p>  <p>SOLD 25 PER PACKAGE ONLY</p> <p>20-617 O'Ring28¢</p>	<p>13/16"O.D. x 9/16" I.D. x 1/8" HGT. (-207)</p>  <p>SOLD 25 PER PACKAGE ONLY</p> <p>20-618 O'Ring28¢</p>
<p>7/8"O.D. x 11/16" I.D. x 3/32" HGT. (-115)</p>  <p>SOLD 25 PER PACKAGE ONLY</p> <p>20-214 O'Ring28¢</p>	<p>7/8"O.D. x 3/4" I.D. x 1/16" HGT. (-018)</p>  <p>SOLD 25 PER PACKAGE ONLY</p> <p>20-619 O'Ring28¢</p>	<p>7/8"O.D. x 5/8" I.D. x 1/8" HGT. (-208)</p>  <p>SOLD 25 PER PACKAGE ONLY</p> <p>20-620 O'Ring28¢</p>
<p>15/16"O.D. x 3/4" I.D. x 3/32" HGT. (-116)</p>  <p>SOLD 25 PER PACKAGE ONLY</p> <p>20-216 O'Ring28¢</p>	<p>15/16"O.D. x 13/16" I.D. x 1/16" HGT. (-019)</p>  <p>SOLD 25 PER PACKAGE ONLY</p> <p>20-227 O'Ring28¢</p>	<p>15/16"O.D. x 11/16" I.D. x 1/8" HGT. (-209)</p>  <p>SOLD 25 PER PACKAGE ONLY</p> <p>20-621 O'Ring28¢</p>

O'RINGS

**USE YOUR CREDIT CARD AT TIME OF PURCHASE AND SAVE 2% ON ALL ORDERS,
SAVE 5% ON ALL ORDERS OVER \$500 OR SAVE 10% ON ALL ORDERS OVER \$1000**

FAX 1-800-982-5934 **www.HODESCO.com** **PHONE 1-800-777-6500**
PROFFERED PLUMBING PRODUCTS **325**

**INTERNAL FAUCET
REPAIR**



BUNA-N O'RINGS

**1"O.D. x 3/4" I.D.
x 1/8" HGT.**

(-210)

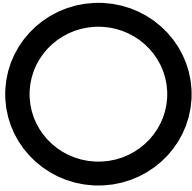

SOLD 25 PER PACKAGE ONLY

20-218 O'Ring **.33¢**

**1"O.D. x 7/8" I.D.
x 1/16" HGT.**

(-020)

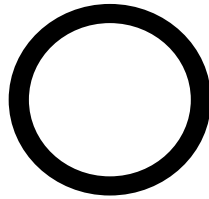

SOLD 25 PER PACKAGE ONLY

20-623 O'Ring **.33¢**

**1"O.D. x 13/16" I.D.
x 3/32" HGT.**

(-117)

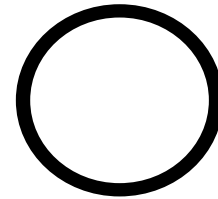

SOLD 25 PER PACKAGE ONLY

20-622 O'Ring **.33¢**

**1-1/16"O.D. x 13/16" I.D.
x 1/8" HGT.**

(-211)

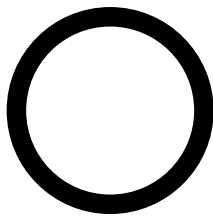

SOLD 25 PER PACKAGE ONLY

20-220 O'Ring **.33¢**

**1-1/16"O.D. x 7/8" I.D.
x 3/32" HGT.**

(-118)

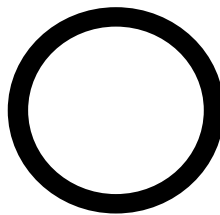

SOLD 25 PER PACKAGE ONLY

20-215 O'Ring **.33¢**

**1-1/16"O.D. x 15/16" I.D.
x 1/16" HGT.**

(-021)

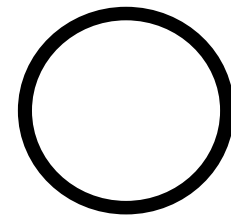

SOLD 25 PER PACKAGE ONLY

20-200 O'Ring **.33¢**

**1-1/8"O.D. x 7/8" I.D.
x 1/8" HGT.**

(-212)

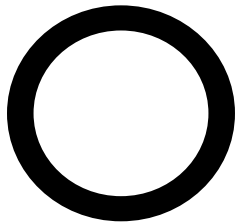

SOLD 25 PER PACKAGE ONLY

20-624 O'Ring **.33¢**

**1-1/8"O.D. x 15/16" I.D.
x 3/32" HGT.**

(-119)

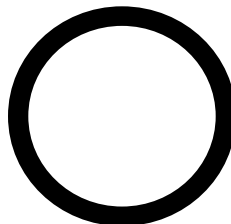

SOLD 25 PER PACKAGE ONLY

20-228 O'Ring **.33¢**

**1-1/8"O.D. x 31/32" I.D.
x 1/16" HGT.**

(-022)

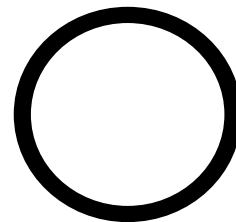

SOLD 25 PER PACKAGE ONLY

20-625 O'Ring **.33¢**

**1-3/16"O.D. x 15/16" I.D.
x 1/8" HGT.**

(-213)

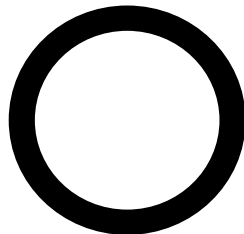

SOLD 25 PER PACKAGE ONLY

20-626 O'Ring **.33¢**

**1-3/16"O.D. x 1-1/16" I.D.
x 1/16" HGT.**

(-023)

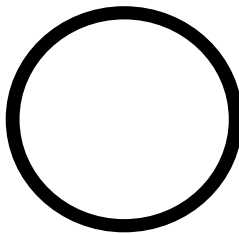

SOLD 25 PER PACKAGE ONLY

20-627 O'Ring **.33¢**

**1-3/16"O.D. x 1" I.D.
x 3/32" HGT.**

(-120)

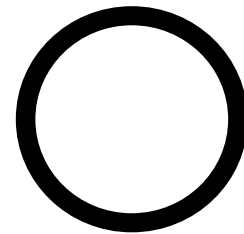

SOLD 25 PER PACKAGE ONLY

20-628 O'Ring **.33¢**

O'RINGS

**USE YOUR CREDIT CARD AT TIME OF PURCHASE AND SAVE 2% ON ALL ORDERS,
SAVE 5% ON ALL ORDERS OVER \$500 OR SAVE 10% ON ALL ORDERS OVER \$1000**

**FAX
1-800-982-5934**
326

www.**HODES CO.**.com
PREFERRED PLUMBING PRODUCTS

**PHONE
1-800-777-6500**

BUNA-N O'RINGS



INTERNAL FAUCET REPAIR

How Would You Like to See
Your Name
on the Products You Sell and
Install?

AT NO CHARGE!

Your logo here Your phone # here

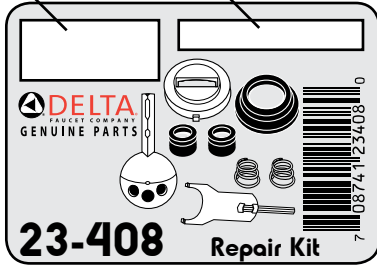

Design Your Own Label Here!
Free On All Products.

**HOW
MUCH
DOES IT
COST?**

FREE
on all orders!!

1-1/4"O.D. x 1-1/16" I.D. (-121)
x 3/32"HGT.

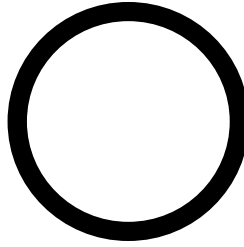

SOLD 25 PER PACKAGE ONLY

20-629 O'Ring **.35¢**

1-1/4"O.D. x 1-1/8" I.D. (-024)
x 1/16"HGT.

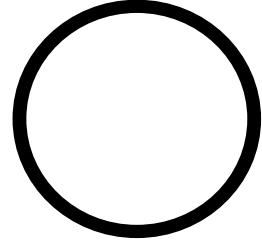

SOLD 25 PER PACKAGE ONLY

20-235 O'Ring **.35¢**

1-1/4"O.D. x 1" I.D. (-214)
x 1/8"HGT.

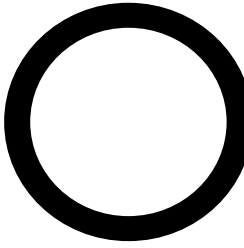

SOLD 25 PER PACKAGE ONLY

20-630 O'Ring **.35¢**

1-5/16"O.D. x 1-1/8" I.D. (-122)
x 3/32"HGT.

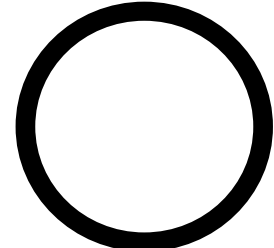

SOLD 25 PER PACKAGE ONLY

20-631 O'Ring **.35¢**

1-3/8"O.D. x 1-1/8" I.D. (-216)
x 1/8"HGT.

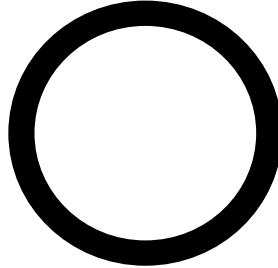

SOLD 25 PER PACKAGE ONLY

20-221 O'Ring **.35¢**

1-3/8"O.D. x 1-3/16" I.D. (-123)
x 3/32"HGT.

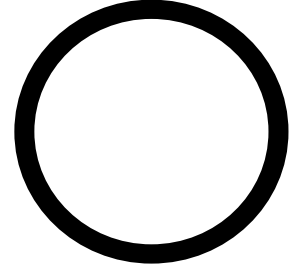

SOLD 25 PER PACKAGE ONLY

20-656 O'Ring **.35¢**

1-7/16"O.D. x 1-5/16" I.D. (-027)
x 1/16"HGT.

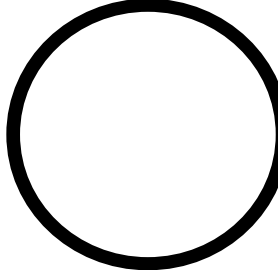

SOLD 25 PER PACKAGE ONLY

20-635 O'Ring **.35¢**

1-1/2"O.D. x 1-1/4" I.D. (-218)
x 1/8"HGT.

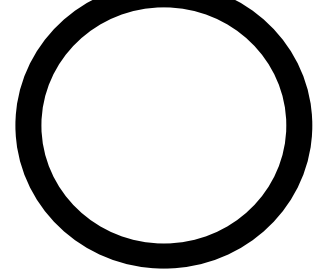

SOLD 25 PER PACKAGE ONLY

20-636 O'Ring **.35¢**

**USE YOUR CREDIT CARD AT TIME OF PURCHASE AND SAVE 2% ON ALL ORDERS,
SAVE 5% ON ALL ORDERS OVER \$500 OR SAVE 10% ON ALL ORDERS OVER \$1000**

**FAX
1-800-982-5934**

www.HODES CO.com
PROFFERED PLUMBING PRODUCTS

**PHONE
1-800-777-6500
327**

O'RINGS

INTERNAL FAUCET REPAIR



BUNA-N O'RINGS

**1-1/2"O.D. x 1-15/16" I.D.
x 3/32" HGT.**

(-125)

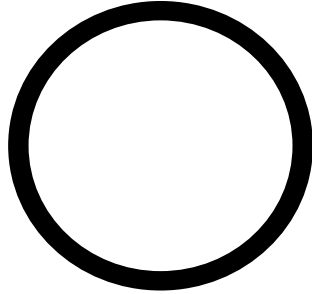

SOLD 25 PER PACKAGE ONLY

20-222 O'Ring **.46¢**

**1-1/2"O.D. x 1-3/8" I.D.
x 1/16" HGT.**

(-028)

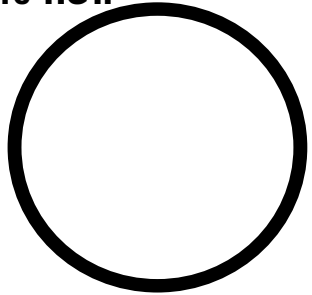

SOLD 25 PER PACKAGE ONLY

20-637 O'Ring **.46¢**

**1-9/16"O.D. x 1-5/16" I.D.
x 1/8" HGT.**

(-219)

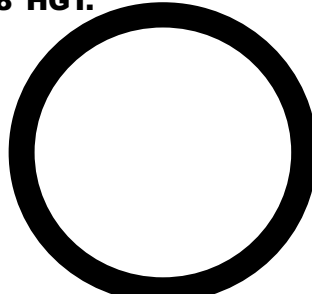

SOLD 25 PER PACKAGE ONLY

20-237 O'Ring **.46¢**

**1-9/16"O.D. x 1-3/8" I.D.
x 3/32" HGT.**

(-126)

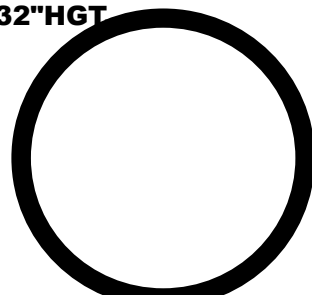

SOLD 25 PER PACKAGE ONLY

20-638 O'Ring **.46¢**

**1-5/8"O.D. x 1-7/16" I.D.
x 3/32" HGT.**

(-127)

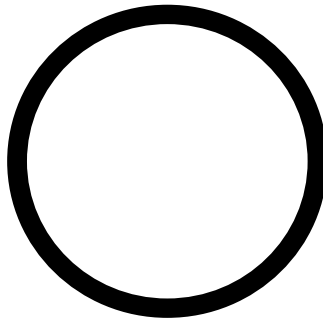

SOLD 25 PER PACKAGE ONLY

20-639 O'Ring **.46¢**

**1-3/4"O.D. x 1-9/16" I.D.
x 3/32" HGT.**

(129)

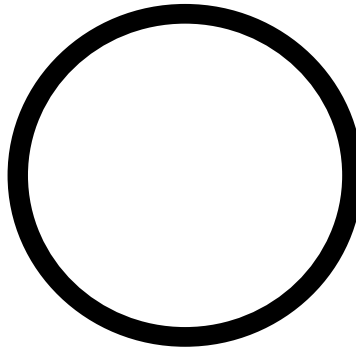

SOLD 25 PER PACKAGE ONLY

20-645 O'Ring **.46¢**

**2-1/8"O.D. x 1-3/4" I.D.
x 3/16" HGT.**

(327)

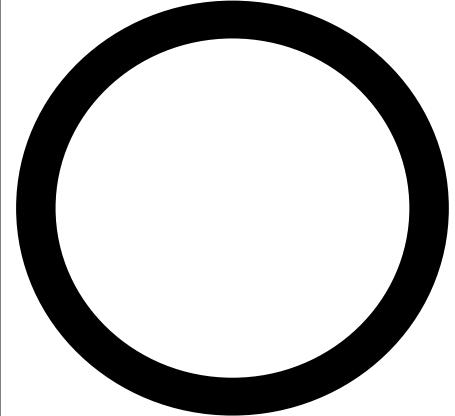

SOLD 25 PER PACKAGE ONLY

20-653 O'Ring **.53¢**

**2-1/8"O.D. x 1-7/8" I.D.
x 1/8" HGT.**

(225)

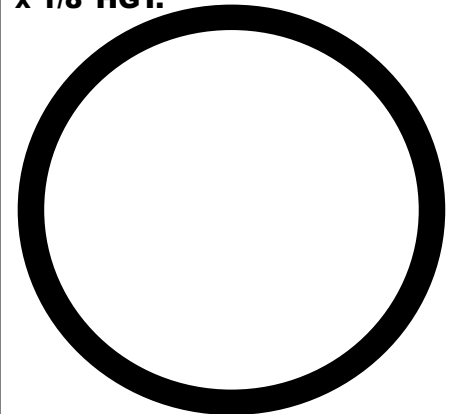

SOLD 25 PER PACKAGE ONLY

20-239 O'Ring **.53¢**

O'RING PIK



20-675 O'Ring / Washer Pik **3.06**

JUMBO O'RING KIT

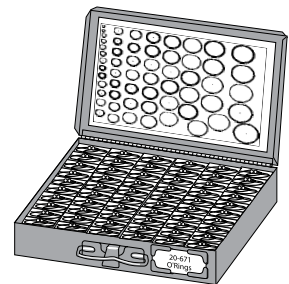

- 502 piece assortment kit
- Illustration chart in lid
- 60 different O'Rings packaged in individual clear plastic boxes for easy identification and access
- Metal box with lock & handle

20-671 502 Pc. Buna-N O'Ring Assortment Kit. **132.24**

O'RINGS

**USE YOUR CREDIT CARD AT TIME OF PURCHASE AND SAVE 2% ON ALL ORDERS,
SAVE 5% ON ALL ORDERS OVER \$500 OR SAVE 10% ON ALL ORDERS OVER \$1000**

FAX 1-800-982-5934 www.HODES CO.com PHONE 1-800-777-6500
328 **HODES CO. PROFFERED PLUMBING PRODUCTS**

O'RINGS



INTERNAL FAUCET REPAIR

Trade Number	Stock Number	Outer Dimension	Inner Dimension	Height
006	20-602	1/4	1/8	1/16
007	20-603	9/32	5/32	1/16
008	20-223	5/16	3/16	1/16
009	20-604	11/32	7/32	1/16
010	20-202	3/8	1/4	1/16
011	20-203	7/16	5/16	1/16
012	20-205	1/2	3/8	1/16
013	20-609	9/16	7/16	1/16
014	20-201	5/8	1/2	1/16
015	20-612	11/16	9/16	1/16
016	20-616	3/4	5/8	1/16
017	20-617	13/16	11/16	1/16
018	20-619	7/8	3/4	1/16
019	20-227	15/16	13/16	1/16
020	20-623	1	7/8	1/16
021	20-200	1-1/16	15/16	1/16
022	20-625	1-1/8	31/32	1/16
023	20-627	1-3/16	1-1/16	1/16
024	20-235	1-1/4	1-1/8	1/16
026	20-633	1-3/8	1-1/4	1/16
027	20-635	1-7/16	1-5/16	1/16
028	20-637	1-1/2	1-3/8	1/16
108	20-605	7/16	5/16	3/32
109	20-607	1/2	5/16	3/32
110	20-204	9/16	3/8	3/32
111	20-206	5/8	7/16	3/32
112	20-208	11/16	1/2	3/32
113	20-210	3/4	9/16	3/32
114	20-212	13/16	5/8	3/32
115	20-214	7/8	11/16	3/32
116	20-216	15/16	3/4	3/32
117	20-622	1	13/16	3/32
118	20-215	1-1/16	7/8	3/32
119	20-228	1-1/8	15/16	3/32
120	20-628	1-3/16	1	3/32
121	20-629	1-1/4	1-1/16	3/32
122	20-631	1-5/16	1-1/8	3/32
123	20-656	1-3/8	1-3/16	3/32
125	20-222	1-1/2	1-5/16	3/32
126	20-638	1-9/16	1-3/8	3/32
127	20-639	1-5/8	1-7/16	3/32
129	20-645	1-3/4	1-9/16	3/32
202	20-606	1/2	1/4	1/8
203	20-224	9/16	5/16	1/8
204	20-610	5/8	3/8	1/8
205	20-207	11/16	1/2	3/32

Trade Number	Stock Number	Outer Dimension	Inner Dimension	Height
206	20-615	3/4	1/2	1/8
207	20-618	13/16	9/16	1/8
208	20-620	7/8	5/8	1/8
209	20-621	15/16	11/16	1/8
210	20-218	1	3/4	1/8
211	20-220	1-1/16	13/16	1/8
212	20-624	1-1/8	7/8	1/8
213	20-626	1-3/16	15/16	1/8
214	20-630	1-1/4	1	1/8
216	20-221	1-3/8	1-1/8	1/8
218	20-636	1-1/2	1-1/4	1/8
219	20-237	1-9/16	1-5/16	1/8
225	20-239	2-1/8	1-7/8	1/8
327	20-653	2-1/8	1-3/4	3/16

O'RINGS

200 ASSORTED O'RINGS

12 POPULAR SIZES

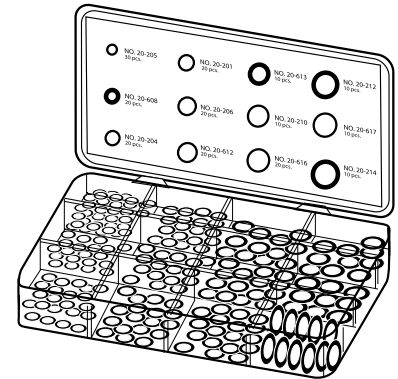

20-234 200 Pc. O'Ring Assortment Kit **12.96**

O'RING SPLICING KIT

THIS SPLICING KIT CONTAINS ALL OF THE MATERIALS NECESSARY TO PROVIDE STATIONARY O'RINGS ON THE SPOT. IDEAL AS A SUPPLEMENT TO YOUR EXISTING O'RING INVENTORY TO ELIMINATE DOWNTIME DELAYS FROM OUT OF STOCK SITUATIONS, OR AS A HANDY FIELD REPAIR KIT. SAVES TIME BY ALLOWING O'RING REPLACING WITHOUT DISASSEMBLING MACHINERY. O'RING CORD IS MADE OF HIGH QUALITY BUNA-N RUBBER.

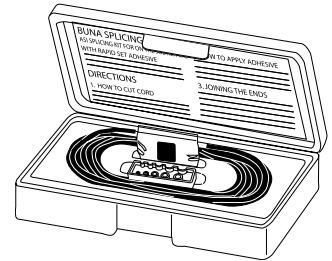

- Kit Contain:
- 3 oz. bottle of adhesive
- Splicing fixture
- Razor blade
- 6' x 3/32" Buna-N cord
- 6' x 1/8" Buna-N cord
- 6' x 3/16" Buna-N cord
- 6' x 1/4" Buna-N cord

20-230 O'Ring Splicing Kit **41.03**

USE YOUR CREDIT CARD AT TIME OF PURCHASE AND SAVE 2% ON ALL ORDERS, SAVE 5% ON ALL ORDERS OVER \$500 OR SAVE 10% ON ALL ORDERS OVER \$1000

Fax 1-800-982-5934 www.HODESCO.com PHONE 1-800-777-6500



INTERNAL FAUCET REPAIR



BOXES AND BAGS

9
8
7
6
5
4
3
2
BOXES AND BAGS

3" x 5" x 4 MIL ZIPLOCK BAG

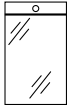

- Clear
- 4 MIL Thickness

NEW

SOLD 100 PER PACKAGE ONLY

88-104 3" x 5" x 4 mil Poly Bag **.10¢**

4" x 6" x 4 MIL ZIPLOCK BAG



- Clear
- 4 MIL Thickness

NEW

SOLD 100 PER PACKAGE ONLY

88-106 4" x 6" x 4 mil Poly Bag **.12¢**

5" x 8" x 4 MIL ZIPLOCK BAG

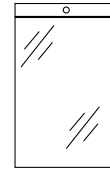

- Clear
- 4 MIL Thickness

NEW

SOLD 100 PER PACKAGE ONLY

88-110 5" x 8" x 4 mil Poly Bag **.13¢**

6" x 9" x 4 MIL ZIPLOCK BAG

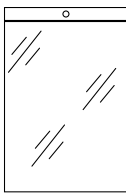

- Clear
- 4 MIL Thickness

NEW

SOLD 100 PER PACKAGE ONLY

88-112 6" x 9" x 4 mil Poly Bag **.16¢**

9" x 12" x 2 MIL ZIPLOCK BAG

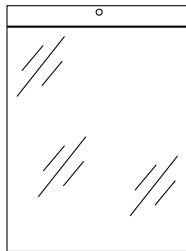

- Clear
- 2 MIL Thickness

NEW

SOLD 100 PER PACKAGE ONLY

88-118 9" x 12" x 2 mil Poly Bag **.30¢**

12" x 15" x 2 MIL ZIPLOCK BAG

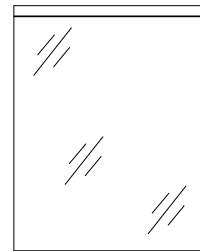

- Clear
- 2 MIL Thickness

NEW

SOLD 100 PER PACKAGE ONLY

88-124 12" x 15" x 2 mil Poly Bag **.30¢**

12" X 2" X 4-1/2" BIN BOX

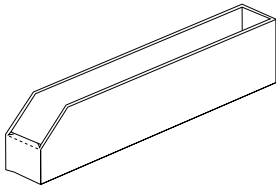

- Heavy Corugated Cardboard

NEW

88-349 12" x 2" x 4-1/2" Bin Box **1.00**

12" X 4" X 4-1/2" BIN BOX

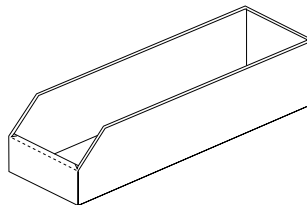

- Heavy Corugated Cardboard

NEW

88-350 12" x 4" x 4-1/2" Bin Box **1.50**

12" X 6" X 4-1/2" BIN BOX

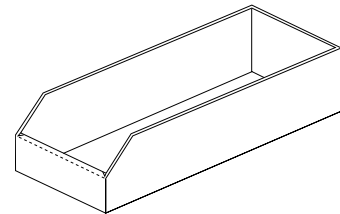

- Heavy Corugated Cardboard

NEW

88-351 12" x 6" x 4-1/2" Bin Box **1.75**

12" X 8" X 4-1/2" BIN BOX

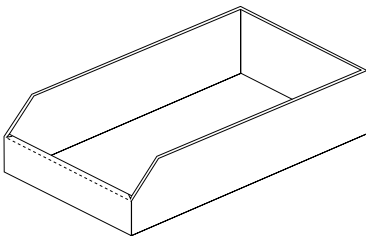

- Heavy Corugated Cardboard

NEW

88-352 12" x 8" x 4-1/2" Bin Box **2.00**

12" X 10" X 4-1/2" BIN BOX

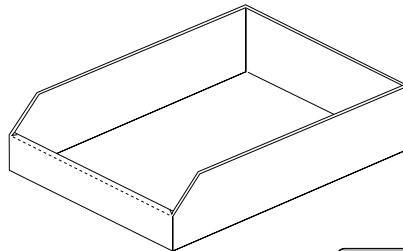

- Heavy Corugated Cardboard

NEW

88-353 12" x 10" x 4-1/2" Bin Box **2.25**

12" X 12" X 4-1/2" BIN BOX

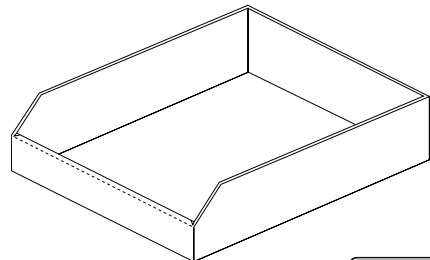

- Heavy Corugated Cardboard

NEW

88-354 12" x 12" x 4-1/2" Bin Box **2.50**

USE YOUR CREDIT CARD AT TIME OF PURCHASE AND SAVE 2% ON ALL ORDERS, SAVE 5% ON ALL ORDERS OVER \$500 OR SAVE 10% ON ALL ORDERS OVER \$1000