

BUY WITH CONFIDENCE.

Over 10,000 items shipped the same day from our ISO 9001:2000 quality certified facility. From Advantage to Shome, we sell the best products at the best possible prices and back them with our 100% satisfaction guarantee.

VALVES, FITTINGS & PIPE REPAIR

Flexible Couplings



SEE PAGE 151

78-734

SHOME VALVE

Full Port Drainable Ball Valve Sweat



SEE PAGE 96

40-430

MISSION

No Hub Coupling



SEE PAGE 151

70-811

SHOME VALVE

Two Piece Heavy Pattern Cast Red Brass Lever Handle Gas Ball Valve

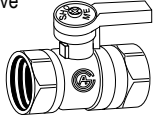

SEE PAGE 103

43-210

Sioux Chief
MANUFACTURING COMPANY, INC.



Mini-Rester™ Water Hammer Arrester Hose Tee



SEE PAGE 150

71-530

SHOME VALVE

Private Label Ball Valve 1/2" SWT



↑
YOUR NAME GOES HERE

SEE PAGE 97

40-986

SHOME VALVE

Heavy Pattern Forged Brass Full Port Ball Valve Sweat



SEE PAGE 96

40-386

Copper Fittings

Coupling With Stop



SEE PAGE 124

79-401

SHOME VALVE

Anti-Siphon Cast Brass Wall Hydrant

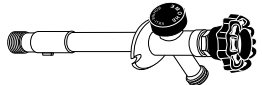

SEE PAGE 106

47-419

SHOME VALVE

Heavy Pattern Forged Brass Full Port Water Heater Ball Valve



SEE PAGE 96

40-850

STUDOR
INC.

Air Admittance Valve



SEE PAGE 109

53-220

Copper Fittings

90° Elbow C x C WROT

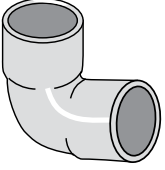

SEE PAGE 123

79-101

Roof Flashings



SEE PAGE 161

53-251

Quarter Turn Tee Handle Boiler Drain

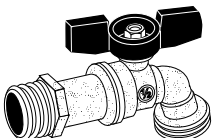

SEE PAGE 102

42-177

90° Black Malleable Banded Elbow 150 PSI



SEE PAGE 138

73-701

Twin Talon 1/2" or 3/4" Pipe

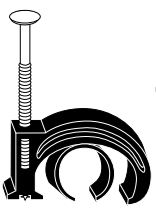

SEE PAGE 158

70-229

USE YOUR CREDIT CARD AT TIME OF PURCHASE AND **SAVE 2%** ON ALL ORDERS, **SAVE 5%** ON ALL ORDERS OVER \$500 OR **SAVE 10%** ON ALL ORDERS OVER \$1000

FAX **1-800-982-5934** www. **HODES CO.** .com PHONE **1-800-777-6500**

PROFFERED PLUMBING PRODUCTS



SHOME BALL VALVES



**HEAVY PATTERN
FORGED BRASS
FULL PORT
BALL VALVES**

All Shome valves are 100% water and air tested before shipment. Manufactured from the highest quality brass content in an ISO 9001:2000-approved factory, you can be assured that the quality you've come to expect from us is reflected in this fine line of plumbing valves.

- Blow out proof stem
- Packing gland nut
- Chromium plated ball
- Teflon packings
- 150 PSI
- 600 lb. WOG

EXCLUSIVE



PRODUCTS



See www.HodesCo.com
for Case Lot Pricing

30 YEAR
WARRANTY

ISO 9001:2000
QUALITY SYSTEM
CERTIFIED

SHOME VALVES

Item ID	Description	Box	Case	Price Ea.
40-338	1/4" IPS	10	90	5.86
40-339	3/8" IPS	10	90	5.86
40-340	1/2" IPS	10	60	5.86
40-341	3/4" IPS	10	40	9.41
40-342	1" IPS	6	30	14.15
40-343	1-1/4" IPS	4	20	23.61
40-344	1-1/2" IPS	4	20	33.07
40-345	2" IPS	2	12	47.27
40-347	3" IPS	1	6	195.15
40-386	1/2" SWEAT	10	60	5.86
40-387	3/4" SWEAT	10	50	9.41
40-388	1" SWEAT	6	30	14.15
40-389	1-1/4" SWEAT	4	20	23.61
40-390	1-1/2" SWEAT	4	20	33.07
40-391	2" SWEAT	2	12	47.27
40-420	1/2" IPS WITH DRAIN	10	60	9.41
40-421	3/4" IPS WITH DRAIN	10	50	14.15
40-422	1" IPS WITH DRAIN	6	36	23.61
41-127	WASTE CAP ONLY FOR DRAIN BALL VALVE	10	50	1.13
40-430	1/2" SWEAT WITH DRAIN	10	60	9.41
40-431	3/4" SWEAT WITH DRAIN	10	60	14.15
40-432	1" SWEAT WITH DRAIN	6	36	23.61
40-292	1/2" COMPRESSION (STANDARD PORT)	10	60	9.28
40-293	3/4" COMPRESSION (STANDARD PORT)	10	50	12.38
40-199	1" COMPRESSION (STANDARD PORT)	10	30	17.71
40-197	1/2" COMPRESSION WITH DRAIN	10	60	9.28
40-198	3/4" COMPRESSION WITH DRAIN	10	50	12.38
40-850	3/4" WATER HEATER DRAIN VALVE WITH CAP	10	50	15.33
40-540	1/2" IPS WITH LATCH LOCK	10	60	9.41
40-541	3/4" IPS WITH LATCH LOCK	10	50	14.15
40-542	1" IPS WITH LATCH LOCK	6	30	17.69
47-367	1/2" BARB X BARB FOR PEX	10	60	6.87
47-368	3/4" BARB X BARB FOR PEX	10	60	7.90
47-369	1" BARB X BARB FOR PEX	10	50	16.55

**USE YOUR CREDIT CARD AT TIME OF PURCHASE AND SAVE 2% ON ALL ORDERS,
SAVE 5% ON ALL ORDERS OVER \$500 OR SAVE 10% ON ALL ORDERS OVER \$1000**

FAX 1-800-982-5934 www.HODES CO .com PHONE 1-800-777-6500

CUSTOM FULL PORT BALL VALVES



**VALVES,
FITTINGS, AND
PIPE REPAIR**

CUSTOMIZED FORGED BRASS FULL PORT BALL VALVES

- Small box qty. customized minimums
- Full color, highest quality print on white handle (see inside front cover)
- Same day shipping after initial order
- **NO SET UP FEE!**

**30 YEAR
WARRANTY**

EXCLUSIVE
HODESCO
PREFERRED PLUMBING PRODUCTS
PRODUCTS

**SEE INSIDE
FRONT COVER
FOR PHOTO**

**ISO 9001:2000
QUALITY SYSTEM
CERTIFIED**

- Blow out proof stem
- Packing gland nut
- Chromium plated ball
- Teflon packings
- 150 PSI
- 600 lb. WOG



Item ID	Description	Min Box	Case	Price Ea.
40-938	1/4" IPS	10	50	7.05
40-939	3/8" IPS	10	50	7.05
40-940	1/2" IPS	10	50	7.05
40-941	3/4" IPS	10	50	10.60
40-942	1" IPS	6	30	15.33
40-943	1-1/4" IPS	4	20	24.79
40-944	1-1/2" IPS	4	20	34.26
40-945	2" IPS	2	10	48.45
40-947	3" IPS	1	5	196.33
40-440	1/2" IPS WITH STAINLESS STEEL HANDLE	10	50	10.60
40-441	3/4" IPS WITH STAINLESS STEEL HANDLE	10	50	16.51
40-442	1" IPS WITH STAINLESS STEEL HANDLE	6	30	22.43
40-986	1/2" SWEAT	10	50	7.05
40-987	3/4" SWEAT	10	50	10.60
40-988	1" SWEAT	6	30	15.33
40-989	1-1/4" SWEAT	4	20	24.79
40-990	1-1/2" SWEAT	4	20	34.26
40-991	2" SWEAT	2	10	48.45
40-486	1/2" SWEAT WITH STAINLESS STEEL HANDLE	10	50	10.60
40-487	3/4" SWEAT WITH STAINLESS STEEL HANDLE	10	50	16.51
40-488	1" SWEAT WITH STAINLESS STEEL HANDLE	6	30	22.43
40-920	1/2" IPS WITH DRAIN	10	50	10.60
40-921	3/4" IPS WITH DRAIN	10	50	15.33
40-922	1" IPS WITH DRAIN	6	30	24.79
40-930	1/2" SWEAT WITH DRAIN	10	50	10.60
40-931	3/4" SWEAT WITH DRAIN	10	50	15.33
40-932	1" SWEAT WITH DRAIN	6	30	24.79
40-992	1/2" COMPRESSION (STANDARD PORT)	10	50	10.46
40-993	3/4" COMPRESSION (STANDARD PORT)	10	50	13.57
40-999	1" COMPRESSION (STANDARD PORT)	6	30	18.89
40-997	1/2" COMPRESSION WITH DRAIN	10	50	10.46
40-998	3/4" COMPRESSION WITH DRAIN	10	50	13.57
40-950	3/4" WATER HEATER DRAIN VALVE WITH CAP	10	50	16.51
47-540	1/2" IPS WITH LATCH LOCK	10	50	10.60
47-541	3/4" IPS WITH LATCH LOCK	10	50	15.33
47-542	1" IPS WITH LATCH LOCK	6	30	18.88
47-967	1/2" BARB X BARB FOR PEX	10	50	8.05
47-968	3/4" BARB X BARB FOR PEX	10	50	9.08
47-969	1" BARB X BARB FOR PEX	6	50	17.73
40-960	1/2" CPVC FULL PORT	10	50	11.66
40-961	3/4" CPVC FULL PORT	10	50	14.26
40-970	1/2" CPVC FULL PORT WITH DRAIN	10	50	12.96
40-971	3/4" CPVC FULL PORT WITH DRAIN	10	50	15.56

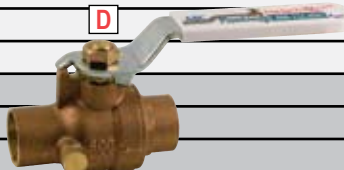
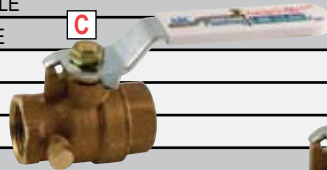

**See www.HodesCo.com
for Case Lot Pricing**

CUSTOM VALVES

**USE YOUR CREDIT CARD AT TIME OF PURCHASE AND SAVE 2% ON ALL ORDERS,
SAVE 5% ON ALL ORDERS OVER \$500 OR SAVE 10% ON ALL ORDERS OVER \$1000**

FAX 1-800-982-5934 www.HODESCO.com PHONE 1-800-777-6500

**VALVES,
FITTINGS, AND
PIPE REPAIR**



BALL VALVES

**IPS X FLANGE
ISOLATION
BALL VALVE
BOLT SET INCLUDED**

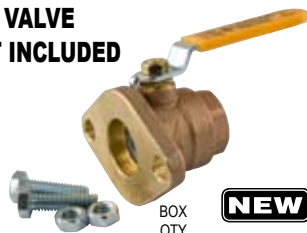

- 150 WSP
 - 600 WOG
- | | | | |
|--------|------------|-----|--------------|
| 47-231 | 3/4" IPS | (6) | 26.70 |
| 47-232 | 1" IPS | (4) | 30.66 |
| 47-233 | 1-1/4" IPS | (4) | 38.43 |

**SWEAT X FLANGE
ISOLATION
BALL VALVE
BOLT SET INCLUDED**



- 150 WSP
 - 600 WOG
- | | | | |
|--------|--------------|-----|--------------|
| 47-331 | 3/4" Sweat | (6) | 26.70 |
| 47-332 | 1" Sweat | (4) | 30.66 |
| 47-333 | 1-1/4" Sweat | (4) | 38.43 |

**RED-WHITE
VALVE CORP.
CAST BRASS
FULL PORT
BALL VALVE**

150 WSP
600 WOG

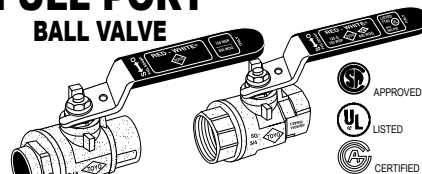

- BOX QTY.
- | | | | |
|--------|------------|------|--------------|
| 40-200 | 1/4" IPS | (80) | 11.70 |
| 40-240 | 1/2" IPS | (80) | 13.01 |
| 40-241 | 3/4" IPS | (60) | 18.72 |
| 40-242 | 1" IPS | (45) | 23.65 |
| 40-250 | 1/2" Sweat | (80) | 13.01 |
| 40-251 | 3/4" Sweat | (60) | 18.72 |
| 40-252 | 1" Sweat | (45) | 23.65 |

**RED-WHITE
VALVE CORP.
BRASS FULL PORT
COMPRESSION BALL VALVE**

- Brass body
- Compression ends
- Teflon seats
- 2 piece body
- Chrome-plated brass ball
- 150 WSP
- 600 WOG

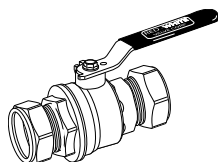

- | | | |
|--------|----------------------------|--------------|
| 40-315 | 1/2" Compression Full Port | 13.93 |
| 40-316 | 3/4" Compression Full Port | 18.69 |
| 40-317 | 1" Compression Full Port | 25.81 |

**SHOME
HANDLE
EXTENSION
KITS**

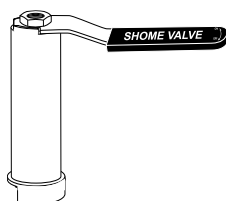

- Move the handle out from tough spots or concealed areas
- 3" extension

BALL VALVE NOT INCLUDED IN KITS. EXTENDS HANDLE 3" FROM NORMAL POSITION! KITS INCLUDE EXTENDER, STEM, HANDLE & NUT!

- | | | |
|--------|---|--------------|
| 49-270 | Handle Extension Kit for 1/2" Valves | 11.37 |
| 49-271 | Handle Extension Kit for 3/4" & 1" Valves | 15.36 |

**SHOME
STAINLESS STEEL
HANDLE
AND NUT**



- Fits Shome Valve full port ball valves
- | | | |
|--------|----------------------------------|-------------|
| 49-240 | 1/2" S. S. Handle and Nut | 3.64 |
| 49-241 | 3/4" and 1" S. S. Handle and Nut | 5.63 |

**SHOME
VALVE** EXCLUSIVE **HODES CO** PRODUCT

**CUSTOM LABELED WATER
HEATER BALL VALVE
INSTALLATION KIT**

- Forged brass hose cap with SS chain
- Blow out proof stem
- Packing gland nut
- Chromium plated ball
- Teflon seats & packing
- 150 PSI
- Individually bagged
- 600 lb WOG
- Full Port
- Cast brass body
- Heavy corrugated box

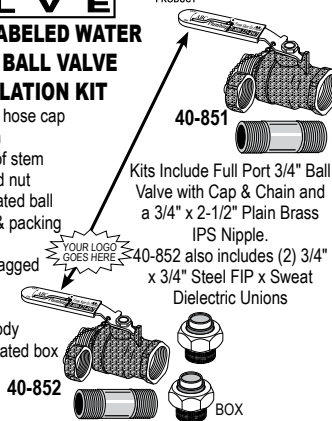

- | | | | |
|--------|------------------------------------|------|--------------|
| 40-851 | Custom Ball Valve Installation Kit | (10) | 18.88 |
| 40-852 | Custom Ball Valve Installation Kit | (10) | 28.34 |

**SHOME
VALVE**

400 WOG
SWEAT

**FORGED BRASS
STANDARD PORT
BALL VALVE**

30 YEAR
WARRANTY



- BOX QTY.
- | | | | |
|--------|------------|------|-------------|
| 47-412 | 1/2" Sweat | (10) | 5.86 |
| 47-413 | 3/4" Sweat | (10) | 8.23 |

**WATTS
REGULATOR** 600 WOG
BRONZE

**STANDARD PORT
BALL VALVE**
GREEN HANDLE
B-6000 SERIES

- Copper sweat
- Hard chrome plated brass ball
- TFE stem packing seal
- Insulated handle

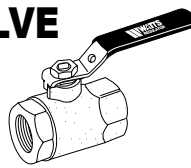

- BOX QTY.
- | | | | |
|--------|----------|------|--------------|
| 40-222 | 1/2" IPS | (10) | 11.70 |
| 40-223 | 3/4" IPS | (10) | 20.07 |
| 40-224 | 1" IPS | (6) | 24.38 |
| 40-232 | 1/2" SWT | (10) | 11.70 |
| 40-233 | 3/4" SWT | (10) | 20.07 |
| 40-234 | 1" SWT | (6) | 24.38 |

**WATTS
REGULATOR** (0531208)

**HEAVY PATTERN FORGED BRASS
COMBINATION
BALL VALVE
AND RELIEF VALVE**

- Provides a unique and low cost solution for thermal expansion relief in domestic water heating systems
- Provides a tight shut off valve for the supply to the water heater
- Easy installation - installs in all positions
- Low profile design
- Full port ball valve with virgin PTTE seats
- Blowout proof stem
- Stainless steel spring/Viton® ball relief valve components
- 400 lb WOG
- 125 PSI

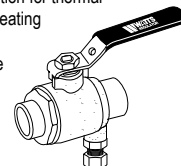

- | | | |
|--------|-----------------------------|--------------|
| 40-268 | Genuine Ball Valve 3/4" SWT | 60.64 |
|--------|-----------------------------|--------------|

**USE YOUR CREDIT CARD AT TIME OF PURCHASE AND SAVE 2% ON ALL ORDERS,
SAVE 5% ON ALL ORDERS OVER \$500 OR SAVE 10% ON ALL ORDERS OVER \$1000**

SHOME VALVES

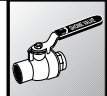

**VALVES,
FITTINGS, AND
PIPE REPAIR**



IPS HEAVY PATTERN

CAST RED BRASS SWING CHECK VALVE WITH FORGED BRASS DISC

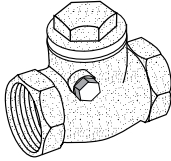

**30 YEAR
WARRANTY**

- 200 lb WOG
- 47-350 1/2" IPS Heavy Pattern Swing Check Valve (10)..... **7.05**
- 47-351 3/4" IPS Heavy Pattern Swing Check Valve (10)..... **9.41**



SWEAT HEAVY PATTERN

CAST RED BRASS SWING CHECK VALVE WITH FORGED BRASS DISC

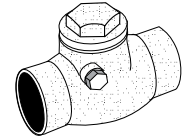

**30 YEAR
WARRANTY**

- 200 lb WOG
- 47-356 1/2" Sweat Heavy Pattern Swing Check Valve (10)..... **7.05**
- 47-357 3/4" Sweat Heavy Pattern Swing Check Valve (10)..... **9.41**
- 47-358 1" Sweat Heavy Pattern Swing Check Valve (10)..... **11.78**



COMPRESSION STOP & WASTE

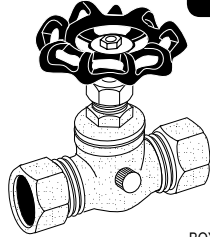

**30 YEAR
WARRANTY**

- With stuffing box
- Cast brass
- 125 lb WOG
- 47-211 3/4" Compression Stop & Waste Valve (10)..... **6.86**



CAST BRASS STOP & WASTE SWEAT

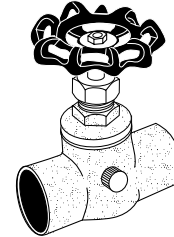

**30 YEAR
WARRANTY**

- With stuffing box
- Cast iron malleable handle
- Brass bibb screw
- 47-064 1/2" Sweat Stop & Waste Valve (10)..... **4.67**
- 47-065 3/4" Sweat Stop & Waste Valve (10)..... **5.85**



ROUGH BRASS ANGLE SILLCOCK FIP

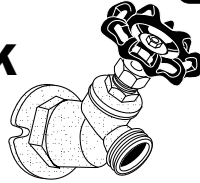

**30 YEAR
WARRANTY**

- Solid flange
- Cast brass
- Ci-mall wheel handle
- Brass bibb screw with stuffing box
- 47-074 1/2" FIP Angle Sillcock (10)..... **5.47**
- 47-075 3/4" FIP Angle Sillcock (10)..... **6.36**



ROUGH BRASS ANGLE SILLCOCK SWEAT

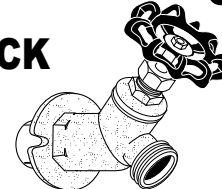

**30 YEAR
WARRANTY**

- Solid flange
- Cast brass
- Ci-mall wheel handle
- Brass bibb screw with stuffing box
- 47-076 1/2" Sweat Angle Sillcock (10)..... **5.47**
- 47-077 3/4" Sweat Angle Sillcock (10)..... **6.36**



ROUGH BRASS STRAIGHT FIP BOILER DRAIN

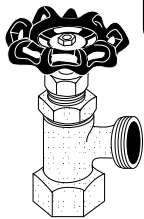

**30 YEAR
WARRANTY**

- With stuffing box
- Cast iron malleable handle
- Brass bibb screws
- Cast brass
- 3/4" hose thread outlet
- 47-069 1/2" FIP Boiler Drain Valve (10)..... **4.71**
- 47-073 3/4" FIP Boiler Drain Valve (10)..... **5.50**



ROUGH BRASS STRAIGHT MIP BOILER DRAIN



**30 YEAR
WARRANTY**

- With stuffing box
- Cast iron malleable handle
- Brass bibb screws
- Cast brass
- 3/4" hose thread outlet
- 47-068 1/2" MIP x C Boiler Drain Valve (10)..... **4.56**
- 47-072 3/4" MIP Boiler Drain Valve (12)..... **5.30**



IPS QUARTER TURN SILLCOCK



**30 YEAR
WARRANTY**

- Tee Handle
- Cast brass
- 47-274 1/2" IPS Quarter Turn Sillcock (10)..... **7.24**
- 47-275 3/4" IPS Quarter Turn Sillcock (10)..... **8.23**



SWEAT QUARTER TURN SILLCOCK



**30 YEAR
WARRANTY**

- Tee Handle
- Cast brass
- 47-276 1/2" Sweat Quarter Turn Sillcock (10)..... **7.59**
- 47-277 3/4" Sweat Quarter Turn Sillcock (10)..... **8.52**

**USE YOUR CREDIT CARD AT TIME OF PURCHASE AND SAVE 2% ON ALL ORDERS,
SAVE 5% ON ALL ORDERS OVER \$500 OR SAVE 10% ON ALL ORDERS OVER \$1000**

FAX 1-800-982-5934 www.HODESCO.com PHONE 1-800-777-6500



SHOME VALVES



PERMALYNX VALVES

PERMALYNX BALL VALVE

PL x PL



- Two-piece body, full port, bronze trim, blowout proof stem, 200 PSI non-shock cold working pressure

47-370	1/2" PL x PL	33.98
47-371	3/4" PL x PL	44.25
47-372	1" PL x PL	54.34

PERMALYNX BALL VALVE

PL x FTG



- Two-piece body, full port, bronze trim, blowout proof stem, 200 PSI non-shock cold working pressure

47-380	1/2" PL x FTG	29.49
47-381	3/4" PL x FTG	42.26
47-382	1" PL x FTG	52.95

PERMALYNX BALL VALVE

PL x HCC



- Two-piece body, full port, bronze trim, blowout proof stem, 200 PSI non-shock cold working pressure
- With hose cap & chain

47-390	1/2" PL x HCC	35.59
47-391	3/4" PL x HCC	37.33



**PAY BY MAJOR CREDIT CARD
WHEN YOU PLACE YOUR ORDER
AND SAVE UP TO AN
ADDITIONAL 10%
OFF OUR ALREADY
INDUSTRY-LOW PRICES!!**

PERMALYNX SUPPLY STOP VALVE W/ESCUTCHEON ANGLE



- Angled
- Quarter turn handle
- 1/2" PL x 3/8" compression

30-910	1/2 x 3/8 x 4"	21.44
30-911	1/2 x 3/8 x 5"	26.50

PERMALYNX SUPPLY STOP VALVE W/ESCUTCHEON STRAIGHT



- Straight
- Quarter turn handle
- 1/2" PL x 3/8" compression

30-901	1/2 x 3/8 x 4"	21.44
30-902	1/2 x 3/8 x 5"	26.50

**USE YOUR CREDIT CARD AT TIME OF PURCHASE AND SAVE 2% ON ALL ORDERS,
SAVE 5% ON ALL ORDERS OVER \$500 OR SAVE 10% ON ALL ORDERS OVER \$1000**

VALVES



VALVES, FITTINGS, AND PIPE REPAIR

KITZ® HEAVY PATTERN CAST BRASS GATE VALVE SWEAT

- 125 lb. steam
- Non-rising stem
- Solid wedge disc
- Full waterway—full threads
- Interchangeable gates
- Screwed in bonnet
- Forged brass integral seat
- 200 WOG

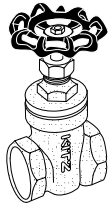

	BOX QTY.	
41-142 1/2" Sweat	(10)	8.29
41-143 3/4" Sweat	(10)	9.78
41-144 1" Sweat	(5)	13.01
41-146 1-1/2" Sweat	(5)	13.61

KITZ® HEAVY PATTERN CAST BRASS GATE VALVE IPS

- 125 lb. steam
- Non-rising stem
- Solid wedge disc
- Full waterway—full threads
- Interchangeable gates
- Screwed in bonnet
- Forged brass integral seat
- 200 WOG

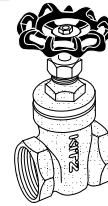

	BOX QTY.	
41-132 1/2" IPS	(10)	8.29
41-133 3/4" IPS	(10)	9.78
41-134 1" IPS	(5)	13.01
41-135 1-1/4" IPS	(5)	13.06



1/2" IPS STOP & WASTE

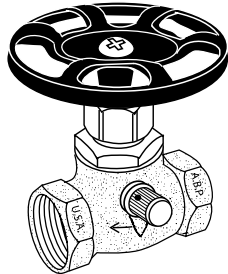

- With stuffing box
- Large wheel handle
- Brass handle screw & bibb screw
- Heavy cast red brass

41-125 1/2" IPS Stop & Waste	(12)	7.01
---	------------	-------------



3/4" IPS STOP & WASTE

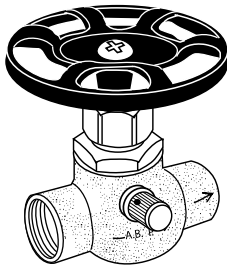

- With stuffing box
- Large wheel handle
- Brass handle screw & bibb screw
- Heavy cast red brass

41-126 3/4" IPS Stop & Waste	(12)	11.20
---	------------	--------------



**PAY BY MAJOR CREDIT CARD
WHEN YOU PLACE YOUR ORDER
AND SAVE UP TO AN
ADDITIONAL 10%
OFF OUR ALREADY
INDUSTRY-LOW PRICES!!**



www.HodesCo.com

HONOR THY PLUMBER™

**USE YOUR CREDIT CARD AT TIME OF PURCHASE AND SAVE 2% ON ALL ORDERS,
SAVE 5% ON ALL ORDERS OVER \$500 OR SAVE 10% ON ALL ORDERS OVER \$1000**

FAX 1-800-982-5934 www.HODESCO.com PHONE 1-800-777-6500





HOSE FAUCETS



(4442007)
(4462007)

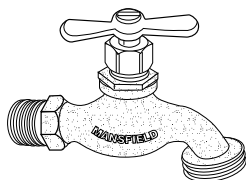

- Tee handle
- With stuffing box
- Cast brass
- 3/4" hose thread outlet

BOX QTY.

42-170 1/2" MIP (10) **7.60**
42-171 3/4" MIP (10) **8.14**



(52643)

HOSE FAUCET COMPRESSION INLET

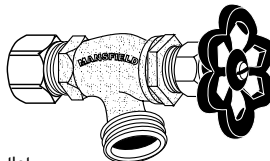

- Compression inlet
- Cast brass
- With stuffing box
- 3/4" hose thread outlet
- Cast iron malleable handle

BOX QTY.

42-179 5/8" OD Inlet (10) **9.27**



(52642)
(52662)

CAST BRASS HOSE FAUCET ROUGH BRASS

- With stuffing box
- Aluminum wheel handle
- Brass bibb screws
- Cast brass
- 3/4" hose thread outlet



BOX QTY.

42-185 1/2" MIP x 1/2" CC (10) **7.24**
42-182 3/4" MIP (10) **7.80**

ARROWHEAD

42-160 1/2" MIP x 1/2" CC (12) **8.06**



(251)
(351)

NO-KINK HOSE FAUCET

- Heavy pattern rough brass
- Stuffing box design
- Coated tee handle

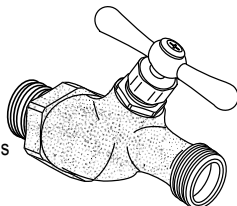

42-186 1/2" MIP x 3/4" Hose Faucet **8.13**
42-187 3/4" MIP x 3/4" Hose Faucet **8.73**



(353)

NO-KINK HOSE FAUCET

- Heavy pattern rough brass
- Stuffing box design
- Coated tee handle

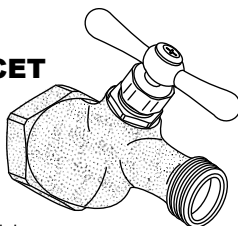

42-189 3/4" FIP x 3/4" Hose Faucet **8.91**



(255)

ANGLE SILLCOCK ROUGH BRASS SWEAT & FIP

- Solid flange
- Heavy cast brass
- Aluminum wheel handle
- Brass bibb screw
- Stuffing box

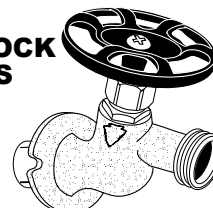

BOX QTY.

42-156 1/2" SWT Rough (6) **9.78**
42-155 1/2" FIP Rough (6) **9.16**
42-158 3/4" FIP Rough (6) **10.01**

HOSE FAUCETS

FAUCET MITTS™

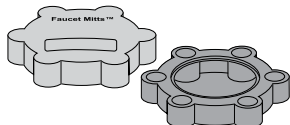

- For use with indoor / outdoor faucet handles
- Fits most 1/2" and 3/4" gate, stop, waste and boiler drain valves and sillcocks
- Color coded (red for hot / blue for cold)
- Lifetime Guarantee

90-850 Faucet Mitts™ Pair (Red & Blue) **3.48**



WASHING MACHINE BI-PASS

- 1/2" FIP x 1/2" MIP
- 3/4" hose thread on bottom
- Satin plated



NEW

42-190 Washing Machine Bi-Pass **11.81**

SILLCOCK/HYDRANT MOUNTING PLATE

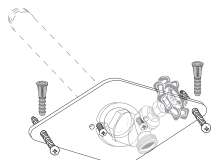

- Holds sillcock/hydrant securely to prevent stresses on plumbing
- Prevents drafts, moisture, insects and vermin from entering the building
- Saves time on installation
- Neat, attractive professional appearance
- Great for use with rigid & flexible water pipe

45-900 Sillcock/Hydrant Mounting Plate **11.48**

FLARED METER VALVE CAST BRASS

- Stop & waste
- Heavy pattern
- Cast red brass stuffing box
- Long nut

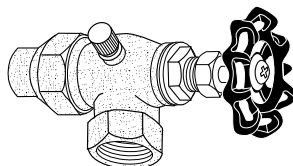

BOX QTY.

41-201 3/4" C x 3/4" IPS (6) **24.09**

QUARTER TURN HOSE BIBB - LIGHT PATTERN

- Cast brass construction
- Threaded ends comply with ANSI B1.20.1 and ASME B1.20.7 Manual spherical shut-off valve 125 WOG
- Cast Brass



NEW

42-277 1/2" Quarter Turn Hose Bibb **5.50**
42-278 3/4" Quarter Turn Hose Bibb **5.79**

CAST BRASS WATER HEATER DRAIN VALVE

- 2-1/2" shank
- 3/4" MIP inlet
- 3/4" garden hose outlet

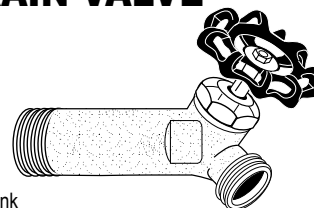

42-196 Water Heater Drain Valve **13.84**

QUARTER TURN TEE HANDLE HOSE BIBB HEAVY PATTERN

- Cast brass construction
- Threaded ends comply with ANSI B1.20.1 and ASME B1.20.7 Manual spherical shut-off valve
- 150 PSI (PN 10) 20° F to 150° F in continuous usage
- Up to 200° F in discontinuous usage
- Individually boxed



42-177 1/2" **11.43**
42-178 3/4" **14.87**

**USE YOUR CREDIT CARD AT TIME OF PURCHASE AND SAVE 2% ON ALL ORDERS,
SAVE 5% ON ALL ORDERS OVER \$500 OR SAVE 10% ON ALL ORDERS OVER \$1000**

**FAX
1-800-982-5934**

www.HODES CO.com
PREFERRED PLUMBING PRODUCTS

**PHONE
1-800-777-6500**

LOG LIGHTER & GAS VALVES

VALVES, FITTINGS, AND PIPE REPAIR



CHROME PLATED CAST BRASS STRAIGHT PATTERN LOG LIGHTER VALVE

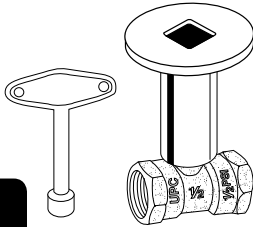

30 YEAR WARRANTY

- BOX QTY
- 43-205 Complete w/Chrome Plated Trim . . (10) . **15.33**
 - 43-207 Complete w/Polished Brass Trim . . (10) . **16.51**



CHROME PLATED CAST BRASS ANGLE PATTERN LOG LIGHTER VALVE

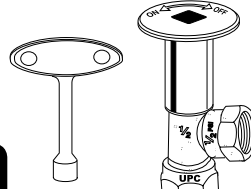

30 YEAR WARRANTY

- BOX QTY
- 43-206 Complete with Chrome Trim. . . (10) . **14.15**
 - 43-208 Complete with Polished Brass Trim (10) . **16.51**
 - 41-236 Chrome Flange Only (10) . **4.68**

FOR WATER ONLY

PVC SOCKET WELD BALL VALVE SLIP X SLIP

- For water use only
- NSF approved
- 150 P.S.I. at 73°
- Individually boxed
- For schedule 40 & 80 pipe
- EPDM seal & O'Ring

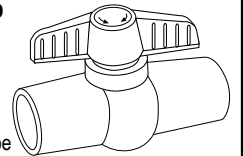

- 40-294 1/2" Slip x Slip Ball Valve. **2.59**
- 40-295 3/4" Slip x Slip Ball Valve **3.53**
- 40-296 1" Slip x Slip Ball Valve. **4.29**
- 40-297 1-1/4" Slip x Slip Ball Valve. **5.33**
- 40-298 1-1/2" Slip x Slip Ball Valve. **8.89**
- 40-299 2" Slip x Slip Ball Valve. **11.90**

LOG LIGHTER KIT AND BURNER

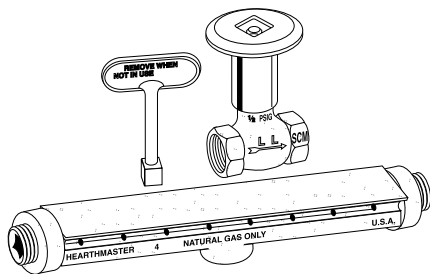

- Large ports
- Bottom entry

- 43-204 3 Pc. Kit Complete **31.68**
- 43-202 2 Plug Iron Burner Only **12.85**

THREE-WAY LOG LIGHTER VALVE

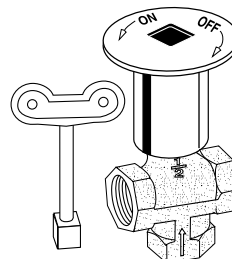

- Valve can be used for a straight or angle installation
- 1/2" brass plug furnished to block off the unused inlet

- 43-200 1/2" IPS 3-Way **39.16**

CPVC SOCKET WELD BALL VALVE SLIP X SLIP

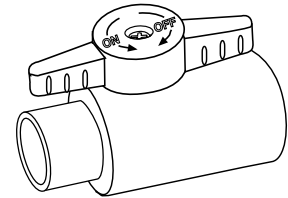

- For hot water systems
- Individually boxed

- 40-281 1/2" Slip x Slip Ball Valve **5.54**
- 40-282 3/4" Slip x Slip Ball Valve **7.30**



TWO PIECE FORGED BRASS GAS BALL VALVE WITH LEVER HANDLE

30 YEAR WARRANTY

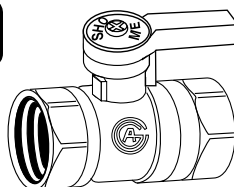

- Teflon® packing and seats
- 400 WOG

- BOX QTY
- 43-210 1/2" Gas Ball Valve. (12) . **4.96**
 - 43-211 3/4" Gas Ball Valve. (12) . **7.45**

TWO PIECE FORGED BRASS GAS BALL VALVE WITH LEVER HANDLE

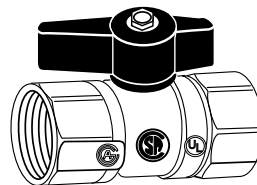

- Double viton O'Ring seals
- Teflon® seats

- BOX QTY
- 43-212 1/2" FIP x FIP (10) . **5.85**
 - 43-213 3/4" FIP x FIP (10) . **8.26**
 - 43-214 1" FIP x FIP (10) . **11.84**

BRASS FLARE GAS BALL VALVE

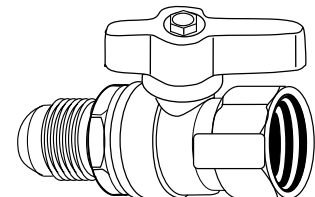

- BOX QTY
- 35-123 1/2" Flare x 1/2" FIP (12) . **7.04**

USE YOUR CREDIT CARD AT TIME OF PURCHASE AND SAVE 2% ON ALL ORDERS, SAVE 5% ON ALL ORDERS OVER \$500 OR SAVE 10% ON ALL ORDERS OVER \$1000

FAX 1-800-982-5934 www.HODESCO.com PHONE 1-800-777-6500



VALVES



**WATTS
REGULATOR**

(374A)

**WATER
PRESSURE
RELIEF VALVE**

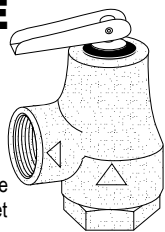

- For boilers set at 30 lbs pressure
- Iron body with forged bronze inlet
- Used on all types of hot water heating boiler equipment.
- Pressure range set at 30 LBS. with 500,000 BTU rating.

1 PER BOX

44-230 3/4" Pressure Relief Valve **44.09**

**WATTS
REGULATOR**

(100XL-175)

**TEMPERATURE
AND PRESSURE
RELIEF VALVE
175 LBS.**

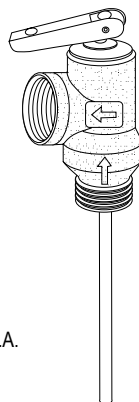

- Heavy brass casting
- Buna-n seat washer
- Stainless steel spring
- Safety test lever
- Approved by A.G.A., A.S.M.E., F.H.A.
- Conforms to #Z-21, 22
- Steam rating—90,000 B.T.U./HR.
- 4" plastic coated extension tube

1 PER BOX - 25 PER CASE

44-207 175 Lbs. 3/4" **11.13**

**WATTS
REGULATOR**

(100XL)
(LL100XL)

**TEMPERATURE AND PRESSURE
RELIEF VALVE
150 LBS**

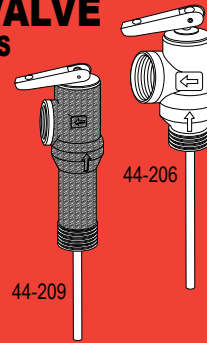

- Heavy brass casting
- Buna-n seat washer
- Stainless steel spring
- Safety test lever
- Approved by A.G.A., A.S.M.E., F.H.A.
- Conforms TO #Z-21, 22
- Steam rating—90,000 B.T.U./HR.
- 4" plastic coated extension tube

1 PER BOX - 25 PER CASE

44-206 150 Lbs. 3/4" **10.57**
44-209 150 Lbs. 3/4" Long Neck **19.41**

**WATTS
REGULATOR**

(40XL)

**COMMERCIAL RELIEF VALVE
AGAASME - AUTOMATIC RESET**

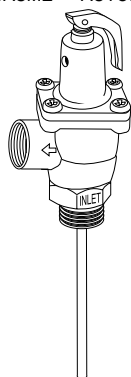

44-217 40XL 3/4" WF 8" Thermostat **143.31**
44-215 40XL 1" WF 4" Thermostat **207.21**

**RELIEF VALVE
DRAIN TUBE**

FOR WATER
HEATER RELIEF
SIDE OUTLET

Save material and labor by using our low cost ready-made tube. Steel threaded fitting, NSF approved plastic tube, full opening.

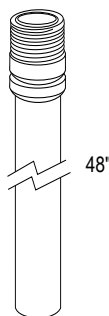

SOLD IN PACKAGE QTY ONLY

53-450 48" Drain Tube (12) **3.50**

**RELIEF VALVE
DRAIN TUBE**

FOR WATER
HEATER RELIEF
TOP OUTLET

Save material and labor by using our low cost ready-made tube. Steel threaded fitting, NSF approved plastic tube, full opening.

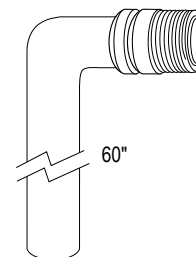

SOLD IN PACKAGE QTY ONLY

53-451 60" Angle for Top Mount (12)



**PAY BY MAJOR CREDIT CARD
WHEN YOU PLACE YOUR ORDER
AND SAVE UP TO AN
ADDITIONAL 10%
OFF OUR ALREADY
INDUSTRY-LOW PRICES!!**

**LEGEND
VALVE**

**HEAVY PATTERN
SOLID BRASS
RADIATOR
VALVES
IPS ANGLE**

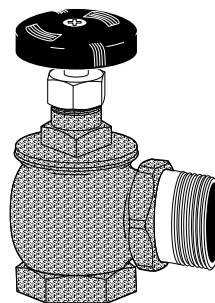

- For steam systems
- Low pressure composition disc

47-400 1/2" IPS Angle Radiator Valve **22.18**
47-401 3/4" IPS Angle Radiator Valve **25.85**
47-402 1" IPS Angle Radiator Valve **33.80**

**WATTS
REGULATOR**

(L70A-F)

**HOT WATER EXTENDER
TEMPERING VALVE
1/2" SWT X SWT**

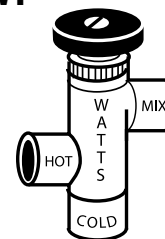

- For residential installation
- Mixes cold and hot water
- Fingertip temperature control
- Standard temperature range 120°F to 160°F
- Max. temperature 210°F
- Max. pressure 150 PSI

44-242 Tempering Valve **133.33**

**USE YOUR CREDIT CARD AT TIME OF PURCHASE AND SAVE 2% ON ALL ORDERS,
SAVE 5% ON ALL ORDERS OVER \$500 OR SAVE 10% ON ALL ORDERS OVER \$1000**

WALL HYDRANTS



VALVES, FITTINGS, AND PIPE REPAIR



(426BFP)

ANTI-SIPHON FROST PROOF FREEZELESS SILLCOCK 1/2" CC x 1/2" MIP

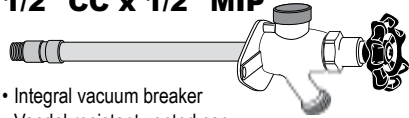

- Integral vacuum breaker
- Vandal-resistant vented cap

42-150	1/2" x 4"	35.16
42-151	1/2" x 6"	35.54
42-152	1/2" x 8"	37.53
42-153	1/2" x 10"	38.78
42-154	1/2" x 12"	39.05
42-149	1/2" x 14"	39.92



(486BFP)

ANTI-SIPHON FROST PROOF FREEZELESS SILLCOCK 1/2" CC x 1/2" MIP

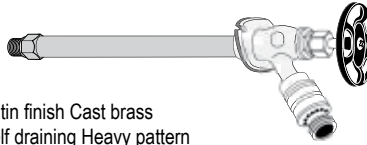

- Satin finish Cast brass
- Self draining Heavy pattern
- Factory installed vandal resistant
- Vacuum breaker
- 3/4" K copper casing

1 PER BOX - 24 PER CASE

ASSE 1019

42-129	1/2" x 8"	36.68
42-124	1/2" x 10"	37.46
42-125	1/2" x 12"	40.30
42-132	1/2" x 14"	35.06



(59BFPCH)



- Self-Draining w/break off feature
- For 486 series hydrants
- Satin plated

NEW

42-128 Fine Threaded Vacuum Breaker . . . **13.98**



(T-550)

QUARTER TURN ANTI-SIPHON FROST-PROOF SILLCOCK



NEW

47-221	1/2" x 8"	33.53
47-222	1/2" x 10"	35.52
47-223	1/2" x 12"	37.44



WALL HYDRANT REPAIR KIT FOR T-550



PARTS INCLUDED:

- Ceramic Cartridge
- Screw
- O-Ring - NBR
- 2 O-Rings - Viton
- Vacuum Breaker
- Seat
- Cap

NEW

47-225 Vacuum Breaker Repair Kit **15.73**



PAY BY MAJOR CREDIT CARD WHEN YOU PLACE YOUR ORDER AND SAVE UP TO AN ADDITIONAL 10% OFF OUR ALREADY INDUSTRY-LOW PRICES!!



(58)

FREEZELESS ANTI-SIPHON HYDRANT

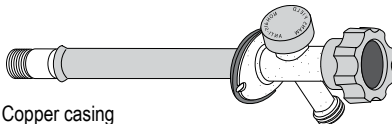

- Copper casing
- Tamper proof lock shield pattern (with handle removed)
- Replaceable bibb washer
- Full flow waterways

CASE QTY

45-108	1/2" CC x 1/2" MIP x 6"	(20) . . .	31.86
45-109	1/2" CC x 1/2" MIP x 8"	(20) . . .	34.38
45-110	1/2" CC x 1/2" MIP x 10"	(20) . . .	34.92
45-111	1/2" CC x 1/2" MIP x 12"	(20) . . .	37.34
45-112	1/2" CC x 1/2" MIP x 14"	(20) . . .	39.64



(630-7755)

WALL HYDRANT REPAIR KIT

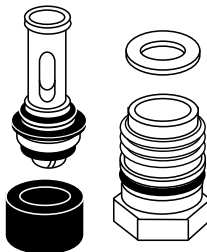

- Repairs anti-siphon and regular frost-proof sillcocks

45-113 Genuine Repair Kit **11.03**



(630-7500)

WALL HYDRANT REPAIR KIT



- Repairs anti-siphon frost-proof sillcocks

42-139 Genuine Repair Kit **5.52**

USE YOUR CREDIT CARD AT TIME OF PURCHASE AND SAVE 2% ON ALL ORDERS, SAVE 5% ON ALL ORDERS OVER \$500 OR SAVE 10% ON ALL ORDERS OVER \$1000

FAX 1-800-982-5934

www.HODES CO.com

PHONE 1-800-777-6500



WALL HYDRANTS

PRIER® FREEZELESS WALL HYDRANT

1/2" CC X 1/2" MIP X 12"

(C-134D)

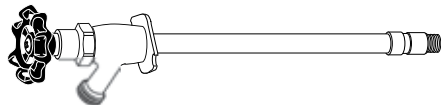

45-133 Genuine 12" Wall Hydrant **43.31**

PRIER® ANTI-SIPHON FREEZELESS WALL HYDRANT

1/2" CC X 1/2" MIP

(C-1440)

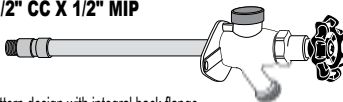

- Heavy pattern design with integral back flange
 - Satin nickel plated cast brass body
 - Powder coat aluminum operating handle
 - Spout alignment lug for simple installation
 - Stem secured at both the handle & seat, allowing manufacture to any size without problems associated with noise or rattling under flow
 - 4" to 24" standard sizes, but can be manufactured to any length
- All the great features of Prier's time tested C-134 with the added protection of an anti-siphon vacuum breaker and integral backflow preventor.

	CASE QTY	
45-172 1/2" x 8"	(10)	35.67
45-173 1/2" x 10"	(10)	40.23
45-174 1/2" x 12"	(10)	38.31
45-175 1/2" x 14"	(10)	39.63

PRIER® ANTI-SIPHON FREEZELESS SLIM SEAT HYDRANT

1/2" CC X 1/2" MIP



NEW

45-176 1/2" x 8"	(10)	36.52
45-177 1/2" x 10"	(10)	37.84
45-178 1/2" x 12"	(10)	39.22
45-179 1/2" x 14"	(10)	40.56

PRIER® WALL HYDRANT REPAIR KIT



41-902 Vacuum Breaker Kit **5.08**

NEW

SHOME VALVE ANTI-SIPHON CAST BRASS WALL HYDRANT

1/2" CC X 1/2" MIP

A.S.S.E.



**30 YEAR
WARRANTY**

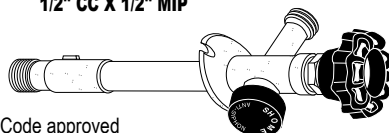

- Code approved
- Large, easy grip handle
- 1/2" male IPS or 1/2" sweat x hose
- Chrome plated body
- Integral anti-siphon and vacuum breaker

SOLD 2 PER BOX ONLY

47-419 1/2" x 8" Anti-Siphon Hydrant	15.91
47-420 1/2" x 10" Anti-Siphon Hydrant	16.55
47-421 1/2" x 12" Anti-Siphon Hydrant	17.58



**Case Lot Pricing
available at
www.HodesCo.com**

SHOME VALVE QUARTER TURN ANTI-SIPHON FROST-PROOF SILLCOCK

A.S.S.E.



- High luster chrome plated
- Integral Vacuum Breaker
- Anti-chatter feature



1/2" CC X 1/2" MIP	
47-119 1/2" x 4"	27.84
47-120 1/2" x 6"	27.84
47-121 1/2" x 8"	27.84
47-122 1/2" x 10"	27.84
47-123 1/2" x 12"	30.75
47-124 1/2" x 14"	35.57

3/4" MIP X 1/2" FIP	
47-927 3/4" x 4"	31.70
47-928 3/4" x 6"	32.57
47-929 3/4" x 8"	33.42
47-930 3/4" x 10"	33.42
47-931 3/4" x 12"	36.33
47-932 3/4" x 14"	37.25

NEW

SHOME VALVE WALL HYDRANT REPAIR KIT



PARTS INCLUDED:

- Vacuum Cover
- VB Body
- VB Disc
- VB Packing
- VB O-Ring

NEW

47-139 Vacuum Breaker Repair Kit **2.30**

**USE YOUR CREDIT CARD AT TIME OF PURCHASE AND SAVE 2% ON ALL ORDERS,
SAVE 5% ON ALL ORDERS OVER \$500 OR SAVE 10% ON ALL ORDERS OVER \$1000**

**FAX
1-800-982-5934**

www.HODESCO.com

**PHONE
1-800-777-6500**

WALL HYDRANTS



VALVES, FITTINGS, AND PIPE REPAIR

WOODFORD FREEZELESS (14C)



WALL FAUCET
1/2" CC X 1/2 MIP

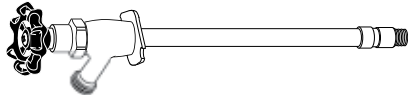

- Lifetime stainless steel seat
- Self aligning flange

45-010	1/2" x 8"(14CP-8)	35.15
45-011	1/2" x 10"(14CP-10)	36.27
45-012	1/2" x 12"(14CP-12)	37.38

WOODFORD (25CP)



**AUTOMATIC DRAINING
FROST PROOF
FREEZELESS
SILLCOCK**
1/2" CC X 1/2 MIP

- Code approved
- No lead solder joints
- Cast brass with copper casing
- Permanent stainless steel seat
- Adjustable flange
- Adjustable nut with teflon packing

ASSE
1019-B

45-058	1/2" x 12"	61.26
--------	------------	-------



HYDRANT STEMS

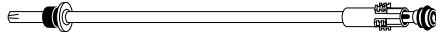

45-103	8" Stem Only - Actual 11-1/2" Mansfield	8.24
45-104	10" Stem Only - Actual 13-1/2" Mansfield	8.39
45-105	12" Stem Only - Actual 15-1/2" Mansfield	10.32

HYDRANT HANDLES



43-330	Mansfield (A)	5.92
41-901	Prier (B)	4.46
43-333	Woodford (C)	2.64
43-334	Woodford (C) (METAL)	2.87

WOODFORD (19CP)



1/2" CC X 1/2" MIP

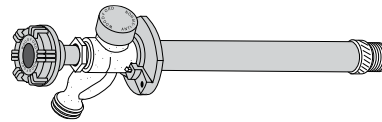

- Automatically reduces the water pressure created by unintentionally leaving a hose attached during freezing conditions
- Oval, powder coated, die-cast aluminum handle

45-070	1/2" x 8"(19CP)	47.48
45-071	1/2" x 10"(19CP)	49.40
45-072	1/2" x 12"(19CP)	50.14

WOODFORD (RK-PRV)



**PRESSURE REDUCING
VALVE REPAIR KIT**

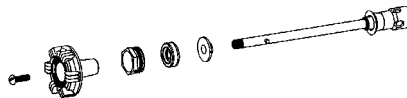

- Total upgrade kit to Model 19
- Retro fit for Model 14, 17 & 22

45-046	8"	33.07
45-047	10"	34.26
45-048	12"	35.44

WOODFORD (RK-25)



**WALL HYDRANT
REPAIR KIT**

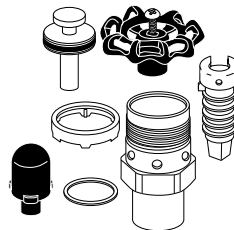

- Repairs Woodford Model #25

45-250	Genuine Repair Kit	39.70
--------	--------------------	-------

WOODFORD



ASSE
1019-C

(17CP-4)
(17CP)
(17C)
(17P)
(17PX)

**ANTI-SIPHON FROST
PROOF FREEZELESS
SILLCOCK**
1/2" CC x 1/2" MIP

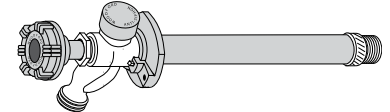

- Code approved
- No lead solder joints
- Cast brass with copper casing
- Permanent stainless steel seat
- Adjustable flange and nut with teflon packing
- 3/4" male hose thread outlet

1 PER BOX - 10 PER CASE

45-044	1/2" x 4" (17 CP)	33.01
45-049	1/2" x 6" (17 CP)	35.24
45-050	1/2" x 8" (17 CP)	35.37
45-051	1/2" x 10" (17 CP)	37.74
45-052	1/2" x 12" (17 CP)	40.11
45-053	1/2" x 14" (17 CP)	42.47
45-081	3/4" x 10" (17 CP)	NEW 37.54
45-082	3/4" x 12" (17 CP)	NEW 39.17
45-083	3/4" x 14" (17 CP)	NEW 40.81
45-054	1/2" SWEAT x 10" (17 C)	36.77
45-055	1/2" SWEAT x 12" (17 C)	39.56
45-045	Repair Kit for #17 (See Below)	24.31
45-060	1/2" x 12" (17 Pex)	37.46

WOODFORD VACUUM BREAKER REPAIR KIT FOR #17 HYDRANTS

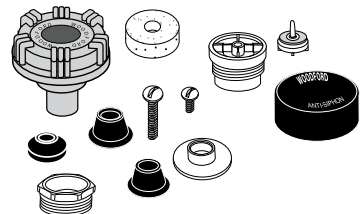

45-045	Genuine Repair Kit	24.31
--------	--------------------	-------

WOODFORD



VACUUM BREAKER

(55057)



- Use on #25, 65, B65 hydrants

45-251	Genuine Vacuum Breaker	23.60
--------	------------------------	-------

**USE YOUR CREDIT CARD AT TIME OF PURCHASE AND SAVE 2% ON ALL ORDERS,
SAVE 5% ON ALL ORDERS OVER \$500 OR SAVE 10% ON ALL ORDERS OVER \$1000**

**FAX
1-800-982-5934**

www.HODES CO.com
PROFFERED PLUMBING PRODUCTS

**PHONE
1-800-777-6500**



WALL HYDRANT PARTS

WOODFORD



**WALL HYDRANT
REPAIR KIT
FOR #14 HYDRANT**



NEW

45-252 Hydrant Repair Kit **15.50**

WOODFORD



**WALL HYDRANT
REPAIR KIT
FOR #70 HYDRANT**



NEW

45-253 Hydrant Repair Kit **58.22**

WOODFORD



**WALL HYDRANT
REPAIR KIT
FOR Y1 HYDRANT**



NEW

45-254 Hydrant Repair Kit **22.30**

WOODFORD



**VACUUM
BREAKER
34 HA**



NEW

45-255 Vacuum Breaker **20.01**

WOODFORD



**VACUUM
BREAKER
37 HA**



NEW

45-256 Vacuum Breaker **30.18**



**PAY BY MAJOR CREDIT CARD
WHEN YOU PLACE YOUR ORDER
AND SAVE UP TO AN
ADDITIONAL 10%
OFF OUR ALREADY
INDUSTRY-LOW PRICES!!**

WOODFORD



**WALL HYDRANT
REPAIR KIT
FOR #22 HYDRANT**



NEW

45-257 Hydrant Repair Kit **29.84**

WOODFORD



**WALL HYDRANT
HOSE
NOZZLE
FOR #22 HYDRANT**



NEW

45-258 Hose Nozzle **8.24**

WOODFORD



**WALL HYDRANT
STEM
SCREW**



NEW

45-259 Stem Screw **2.92**

**USE YOUR CREDIT CARD AT TIME OF PURCHASE AND SAVE 2% ON ALL ORDERS,
SAVE 5% ON ALL ORDERS OVER \$500 OR SAVE 10% ON ALL ORDERS OVER \$1000**

**FAX
1-800-982-5934**

www.HODES CO.com
PROFERRED PLUMBING PRODUCTS

**PHONE
1-800-777-6500**

WALL HYDRANT PARTS

VALVES



VALVES, FITTINGS, AND PIPE REPAIR

1-1/2" - 2" SURE-VENT II AIR ADMITTANCE VALVE

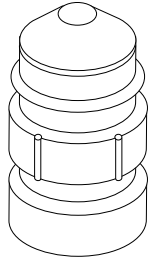

- Use on DWV, PVC pipe diameters up to 2"
- Allows air into plumbing system while containing foul odors.
- Vent at the source - eliminates vent pipe through the roof.

53-225 Sure Vent II **29.46**

1-1/2"-2" RECTORSEAL MAGIC VENT™ AND ADAPTER AIR ADMITTANCE VALVE

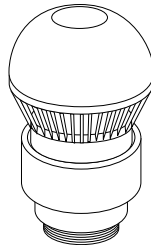

- Easy to install with adapter fitting
- Eliminates roof penetration

53-226 Rectorseal **29.46**

STUDOR® AIR ADMITTANCE REDI-VENT® VALVE

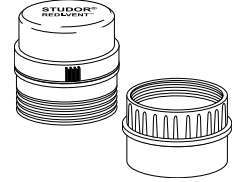

- Provides plumbing ventilation to prevent the loss of water seals in traps without the need for costly roof penetration and vent piping
- For venting single fixtures such as island sinks
- Unique ball valve sealing assembly
- Will vent small bathrooms & groups up to 6 DFU
- Exclusive vermin protection system
- Fit 1-1/2" and 2" pipe sizes

53-222 Redi-Vent™ Air Admittance Valve .. **33.06**

STUDOR® AIR ADMITTANCE VALVE

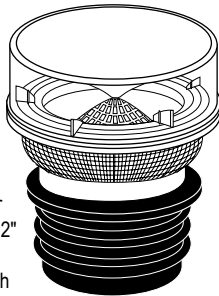

- For drain, branch, stack or vent sizes 1-1/4" through 2" use mini valve
- Up to 160 DFU's on branch
- Up to 500 DFU's on stack

53-220 Mini Air Admittance Valve **37.80**
53-221 Maxi Air Admittance Valve **55.59**

WATTS REGULATOR FLOAT VENT

(FV4)

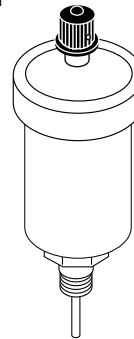

- For automatic air venting
- Max. temp. 240° F
- Max. pressure 150 PSI
- OEM #FV4

1 PER BOX - 144 PER CASE

43-282 1/8" Float Vent **10.03**
43-283 1/4" Float Vent **NEW 12.32**



(EB-25)

3/4" PRESSURE REDUCING VALVE

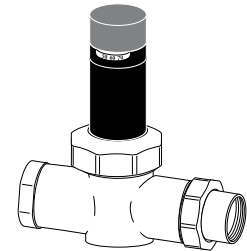

- Range 20-90
- Threaded by Union Inlet with strainer

44-113 Genuine 3/4" Valve **82.63**



PRESSURE REDUCING VALVE



- Built in by-pass
- Range 25 - 75
- Max Inlet 300 PSI

44-900 Genuine 1/2" Pressure Reducing Valve. . **52.97**
44-901 Genuine 3/4" Pressure Reducing Valve. . **65.07**
44-902 Genuine 1" Pressure Reducing Valve ... **82.10**



(25AUB)

PRESSURE REDUCING VALVE

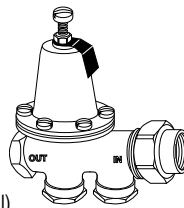

- Built-in bypass
- Monel metal strainer (integral)
- Maximum initial pressure 250 LBS.
- Set to deliver 50 LBS.
- Buna-n diaphragm

WITH UNION

1 PER BOX - 6 PER CASE
REPAIR KITS AVAILABLE ON REQUEST

44-101 3/4" IPS **103.64**
44-102 1" IPS **140.85**



(N55BU)

PRESSURE REDUCING VALVE



- Built-in bypass
- Stainless steel strainer (integral)
- Maximum initial pressure 400 LBS.
- 3/4" union

1 PER BOX - 6 PER CASE

44-104 Watts (N35BU) **64.95**

USE YOUR CREDIT CARD AT TIME OF PURCHASE AND SAVE 2% ON ALL ORDERS, SAVE 5% ON ALL ORDERS OVER \$500 OR SAVE 10% ON ALL ORDERS OVER \$1000

**FAX
1-800-982-5934**

www.HODES CO.com
PROFFERED PLUMBING PRODUCTS

**PHONE
1-800-777-6500
109**

VALVES



NEW

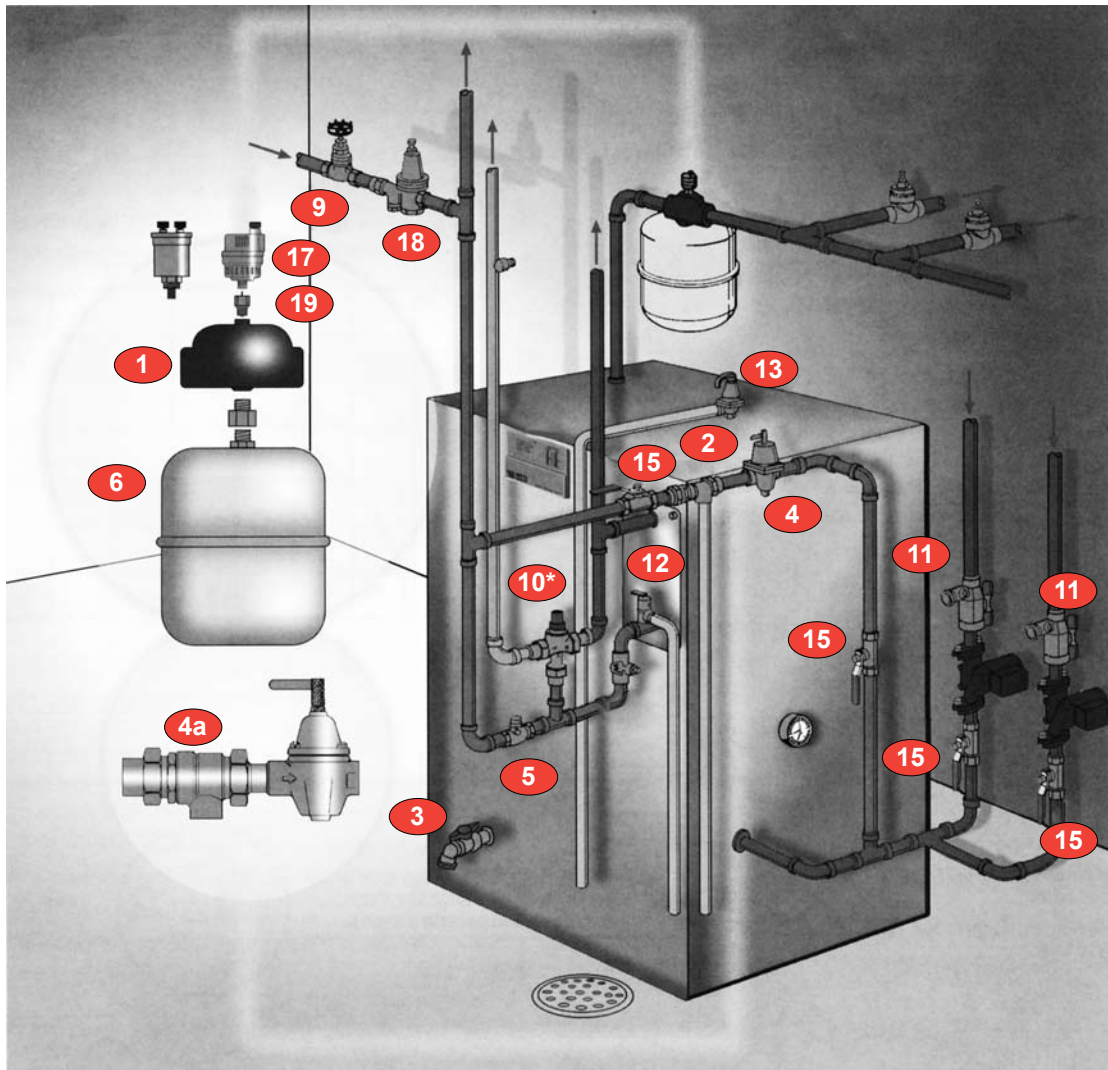

HYDRONIC HEATING

1 Air Scoop	112	10* Mixing Valve	104,112
2 Backflow Preventer	112	11 Purge Valve	98
3 Boiler Drain Valve	102	12 Hot Water Boiler Safety Relief Valve	111
4 Boiler Fill Valve	111	13 Ball Valve	98
4a Fill Valve and Backflow Preventer	112	15 Float Valve	109
5 Bronze Check Valve	99	17	
6 ET Expansion Tank	112	18 Water Pressure Reducing Valve	109
9 Gate or Globe Valve	101	19 Service Check Valve	111

**USE YOUR CREDIT CARD AT TIME OF PURCHASE AND SAVE 2% ON ALL ORDERS,
SAVE 5% ON ALL ORDERS OVER \$500 OR SAVE 10% ON ALL ORDERS OVER \$1000**



HYDRONC HEATING



**VALVES,
FITTINGS, AND
PIPE REPAIR**



1/2" FEED WATER PRESSURE REGULATOR



- Size 1/2" (15mm)
- Maximum working pressure: 100 psi (6.9 bars)
- Maximum temperature: 212°F (100°C)
- Adjustment range:
10 - 25 psi (68.7 - 172.4 kPa) Set at 15 psi (103.4 kPa)

Series 1156F

NEW

- 44-250 Pressure Regulator **47.09**
44-253 Pressure Regulator - Solder Union **55.98**



3/4" FEED WATER PRESSURE REGULATOR



- Size 3/4" (20mm)
- Tight seating check valve with integral strainer and unitized design for simplified servicing
- Set at 15 psi (103.4 kPa)
- Maximum working pressure: 100 psi (6.9 bars)
- Maximum temperature: 212°F (100°C)

Series N256

NEW

- 44-254 3/4" Bronze Body Feed Water Pressure Regulator **99.56**



SERVICE CHECK VALVES



- Spring loaded valve opens to system pressure
- Not to be used on safety relief valves.
- System pressure must be reduced prior to removing system components

Series SCV

NEW

- 43-290 1/8" Service Check Valve **6.54**
43-291 1/4" Service Check Valve **10.90**



BRONZE SILENT CHECK VALVE



- PTFE seats and brass disc
- Install in a horizontal or vertical position
- Stainless steel guide rod and spring
- Silent check operation
- Prevents water hammer

Series 600

NEW

- 43-295 1/2" Silent Check Valve **14.82**
43-296 3/4" Silent Check Valve **19.60**



A.S.M.E. WATER PRESSURE SAFETY RELIEF VALVE



- Size 3/4" (20mm)
- Bronze body
- Standard setting 30 psi
- Safety relief valve for pressure protection only of hot water heating boiler equipment

Series 174A

NEW

- 44-231 3/4" 174A Boiler Relief Valve **94.22**



IRON BODY SAFETY RELIEF VALVE



- Size 3/4" (20mm)
- Iron body
- Standard setting 30 psi
- Expanded outlets for hot water space heating boilers
- Seat located above drain, water can't be trapped and sediment can't foul seat
- Non-mechanical seat-to-disc alignment
- Water seal of high temperature resisting material isolates spring working parts from water during relief

Series 740

NEW

- 44-232 3/4" 740 Boiler Relief Valve **102.44**

**USE YOUR CREDIT CARD AT TIME OF PURCHASE AND SAVE 2% ON ALL ORDERS,
SAVE 5% ON ALL ORDERS OVER \$500 OR SAVE 10% ON ALL ORDERS OVER \$1000**

FAX 1-800-982-5934 www.HODESCO.com PHONE 1-800-777-6500





**WATTS
REGULATOR**

**COMBINATION FILL
VALVE AND BACKFLOW
PREVENTER**



- Maximum pressure: 100 psi (6.9 bars)
- Maximum temperature: 212°F (100°C)
- Boiler fill valve set at 15 psi (103.4 kPa)

**SERIES 911
SERIES 911-S**

NEW

44-240	1/2" Combo Fill Valve W/Backflow	232.62
44-241	1/2" Combo Fill Valve -SWT	232.62

**WATTS
REGULATOR**

**COMBINATION
FILL VALVE AND
BACKFLOW
PREVENTER**

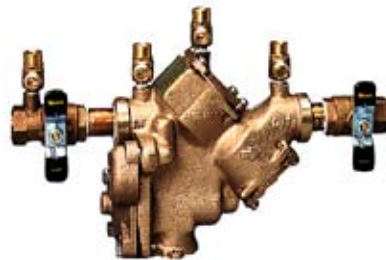

- Maximum working pressure: 175 psi (12.06 bars)
- Maximum temperature: 140°F (60°C)
- Bronze body connection
- Replaceable seats
- Modular design

SERIES 909

NEW

44-245	3/4" Backflow with 1/4 Turn Valve	416.56
44-246	3/4" Backflow with Bronze Strainer	448.36

**WATTS
REGULATOR**

**HOT WATER
TEMPERATURE
CONTROL
VALVES**

- For use at the hot water source to maintain and limit temperature in domestic systems
- Recommended inlet temp:
Hot inlet 120°F - 200°F
Cold inlet 40°F - 85°F
- Maximum pressure: 150 psi
- Maximum temperature: 200°F



SERIES 1170

NEW

44-275	1/2" SWT Mixing Valve	119.10
44-276	1/2" IPS Mixing Valve	119.10
44-277	3/4" SWT Mixing Valve	148.32
44-278	3/4" IPS Mixing Valve	155.72

**WATTS
REGULATOR**

**BACKFLOW PREVENTER
WITH INTERMEDIATE
ATOMOSPHERIC VENT**



- Maximum working pressure: 175 psi (12.06 bars)
- Maximum temperature: 180°F (82°C) sustained, 250°F (121°C) intermittent

SERIES 9D

NEW

44-123	1/2" Backflow with Vent	73.62
44-124	3/4" Backflow with Vent	80.10

**WATTS
REGULATOR**

**HEAVY DUTY
CAST IRON AIR
SCOOPS**



44-260

**SERIES AS
SERIES AS-T**

NEW

- Maximum working pressure: 80 psi (551 kPa)
- Maximum operating temperature: 275 (135°C)
- Heavy cast iron construction

44-260	1" Cast Iron Air Scoop (Shown)	31.80
44-261	1" Cast Iron Air Scoop w/Tappings	36.60

**WATTS
REGULATOR**

**NON-POTABLE WATER
EXPANSION TANK
FOR HOT WATER
HEATING BOILERS
AND SYSTEMS**



- Precharged at 12psi (82.7 kPa)
- Steel construction
- Rugged flexible diaphragm
- Maximum pressure: 60 psi
- Maximum temperature: 240°F

SERIES ET

NEW

44-270	ET-15 Expansion Tank	51.14
44-271	ET-30 Expansion Tank	63.80

**USE YOUR CREDIT CARD AT TIME OF PURCHASE AND SAVE 2% ON ALL ORDERS,
SAVE 5% ON ALL ORDERS OVER \$500 OR SAVE 10% ON ALL ORDERS OVER \$1000**

VALVES



**VALVES,
FITTINGS, AND
PIPE REPAIR**



FLO-CHECK VALVE PVC

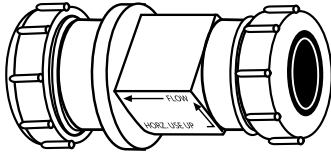

• For sump pumps, ejectors, spas, pools

	BOX QTY.	
53-309	1-1/4"-1-1/2" x 4" (6)	15.19
53-310	2" x 9-3/4" (6)	40.95

"SILENCER" CHECK VALVE WITH RUBBER HOSE COUPLINGS



- Eliminates typical hammering from standard check valves
- No mechanical parts
- Made from high impact ABS
- All mounting hardware included

53-360	1-1/2" "Silencer" Check Valve	14.49
53-361	2" "Silencer" Check Valve	18.13

PVC PRO SPAN EXPANSION COUPLING

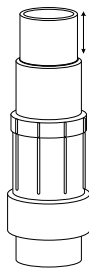

- Double "O" rings design gives greater protection against possible leaks due to pipe deflection. The "O" rings are of high grade EPDM, an elastomeric compound.
- Glue well feature prevents glue from entering the body and clogging the unit during installation
- Easy to install and eliminates the need to dig large section to repair broken PVC water pipes

73-990	3/4" PVC Pro Span Coupling	4.73
73-991	1" PVC Pro Span Coupling	5.65
73-992	1-1/2" PVC Pro Span Coupling	11.62
73-993	2" PVC Pro Span Coupling	17.19

COMBO PUMP CHECK VALVE

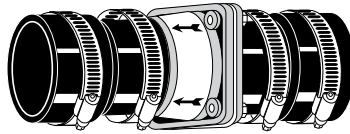

53-307	1-1/4"-1-1/2" Combo Check Valve	10.30
53-297	2" Combo Check Valve	22.46

SILENT BALL/CHECK COMBO VALVE UNION SWING COMBO



53-365	1-1/2" Ball/Check Union Swing Combo	32.37
53-366	2" Ball/Check Union Swing Comb	37.91
20-673	1-1/2" O-Ring Only	.56¢
20-674	2" O-Ring Only	.56¢

PVC QUIET CHECK VALVE



- Eliminates water hammer noise
- Union x Union connection

NEW

53-318	1-1/2" PVC Quiet Check Valve	18.00
53-320	2" PVC Quiet Check Valve	26.03



SWEAT HEAVY PATTERN CAST RED BRASS SWING CHECK VALVE WITH FORGED BRASS DISC

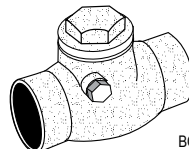

• 200 lb WOG

47-358	1" Sweat Swing Check Valve (6)	11.78
--------	--------------------------------	-------

GENERAL COMPARE



(30-0181)
(30-0021)

COMBO PUMP CHECK VALVE

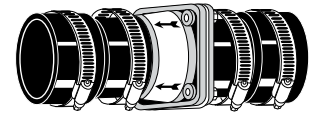

- Includes valve, 2 rubber unions, 4 clamps

53-298	1-1/4"-1-1/2" Combo Check	13.46
53-299	2" Combo Check	29.82
53-308	Rubber Coupling (End Piece Only)	5.12

COMBINATION CHECK/BALL VALVE (SOCKET X SOCKET)

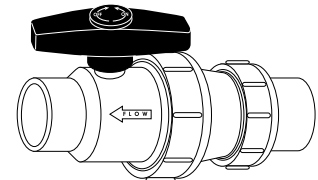

53-311	1-1/2" Combo Valve	29.36
53-312	2" Combo Valve	40.48

SLIP X SLIP CHECK VALVE



- Pressure tested
- Economical price

NEW

53-362	1-1/2" Slip x Slip Check Valve	9.16
--------	--------------------------------	------

WATTS REGULATOR THREADED DUAL CHECK BACKFLOW PREVENTER

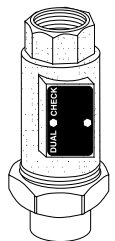

- Bronze body
- Installs immediately downstream of meter
- Two compact replaceable check modules
- Can be installed horizontally or vertically

44-120	1/2" FIP x 1/2" Fe Union	35.01
44-121	3/4" FIP x 3/4" Fe Union	51.69

**USE YOUR CREDIT CARD AT TIME OF PURCHASE AND SAVE 2% ON ALL ORDERS,
SAVE 5% ON ALL ORDERS OVER \$500 OR SAVE 10% ON ALL ORDERS OVER \$1000**

**FAX
1-800-982-5934**

www.HODES CO.com
PROFFERED PLUMBING PRODUCTS

**PHONE
1-800-777-6500**



**SHOME
VALVE**

**SOLID BRASS
VACUUM
BREAKER**

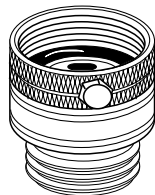

- Prevents backflow of contaminated water
- Heavy brass body
- Silicone rubber and stainless steel parts
- 3/4" female hose & 3/4" male hose
- Breakaway vandal proof set screw

1 PER BOX - 12 PER CASE

47-055 Plain Brass Vacuum Breaker **4.06**
42-301 Chrome Plated Vacuum Breaker **5.07**

**WATTS
REGULATOR**

**SOLID BRASS
VACUUM
BREAKER**

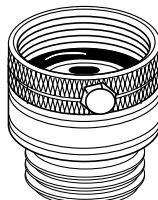

42-300

- Prevents backflow of contaminated water
- Heavy brass body
- Silicone rubber and stainless steel parts
- 3/4" female hose & 3/4" male hose

42-300 (#8) Vacuum Breaker (Brass) **19.89**
42-303 (NF8) For Frost Proof Hydrants **23.24**

CASH ACME

**SELF-DRAINING
SOLID BRASS
BACKFLOW
PREVENTER**

(VB222)

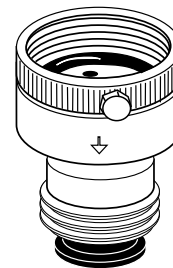

- Nebraska code approved
- Hose bibb type - Self draining
- Female hose x male hose
- Breakaway set screw
- ASSE approved
- Anti-freeze

42-311 Vacuum Breaker **11.67**

**ICE MAKER
INSTALLATION
KIT**

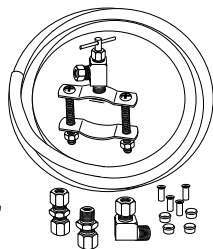

- Designed to fit 1/2" or 3/4" IPS or SWT
- Outlet takes 1/4" OD copper

12 PER BOX

43-255 10 Pc. Kit **9.05**
43-265 Poly—14 Pc. Kit **11.70**
43-266 Copper—14 Pc. Kit **34.27**
43-261 Saddle Valve Only **6.34**



www.HodesCo.com

**BACKWATER
VALVES**



- Seals floor drains against sewage backup
- Cast brass with rubber sealing ring & float ball
- Available with o-ring or spud seal

53-216 2" Plastic **5.83**
52-215 2" Brass **23.17**

**SOLID BRASS
COMPRESSION X MALE PIPE
NEEDLE VALVE**

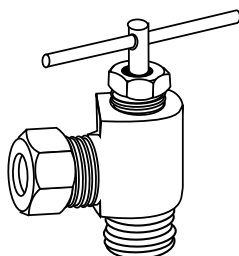

25 PER BAG

43-262 1/4" OD x 1/8" MIP **3.73**

**SOLID BRASS
COMPRESSION X COMPRESSION
NEEDLE VALVE**

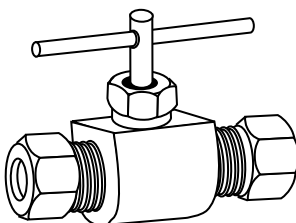

25 PER BAG

43-263 1/4" OD x 1/4" OD **5.23**
43-264 3/8" OD x 3/8" OD **6.23**

**SOLID BRASS
COMPRESSION X COMPRESSION
NEEDLE VALVE
WITH TEE**

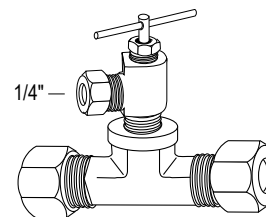

25 PER BAG

43-267 3/8" Valve **8.51**
43-269 5/8" Valve **15.65**

**USE YOUR CREDIT CARD AT TIME OF PURCHASE AND SAVE 2% ON ALL ORDERS,
SAVE 5% ON ALL ORDERS OVER \$500 OR SAVE 10% ON ALL ORDERS OVER \$1000**

FITTINGS



**VALVES,
FITTINGS, AND
PIPE REPAIR**

DIELECTRIC UNION STEEL FIP X SWEAT

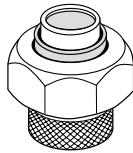

- For commercial, residential
- Prevents corrosion caused by joining two dissimilar metals

BOX
QTY

77-110	Generic 1/2" x 1/2"	(12)	4.68
77-112	Generic 3/4" x 1/2"	(12)	5.34
77-111	Generic 3/4" x 3/4"	(12)	4.94
77-116	Generic 1" x 1"	(12)	7.39
77-117	Generic 1-1/4" x 1-1/4"	(12)	10.47
77-118	Generic 1-1/2" x 1-1/2"	(12)	16.12
77-119	Generic 2" x 2"	(6)	21.86

COMPARE

WATTS REGULATOR DIELECTRIC UNION STEEL FIP X SWEAT

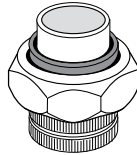

BOX
QTY

72-110	Genuine 1/2" x 1/2"	(12)	7.28
72-111	Genuine 3/4" x 3/4"	(12)	7.42
72-116	Genuine 1" x 1"	(12)	12.93
72-118	Genuine 1-1/2" x 1-1/2"	(12)	27.03
72-112	Genuine 1/2" x		

WATTS REGULATOR DIELECTRIC UNION SWEAT X BRASS FIP

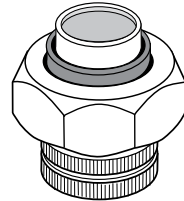

BOX
QTY

72-215	3/4" x 3/4"	(12)	21.34
--------	-------------	------	--------------

WATTS REGULATOR DIELECTRIC UNION SWEAT X STEEL MIP

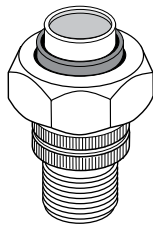

BOX
QTY

72-113	Genuine 1/2" x 1/2"	(12)	10.59
72-115	Genuine 3/4" x 3/4"	(12)	11.77
77-114	Generic 1/2" x 3/4"	(12)	6.10
77-115	Generic 3/4" x 3/4"	(12)	5.56

DIELECTRIC UNION WASHERS



73-163	1/2"	.78¢
73-164	3/4"	.84¢
73-165	1"	.93¢
73-168	2"	1.00

PVC IRON PIPE COMPRESSION COUPLING SLIP X SLIP

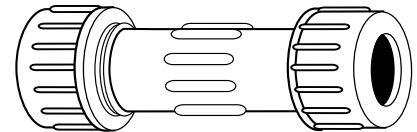

73-135	1/2" X 4"	1.77
73-136	3/4" X 4-1/4"	2.13
73-137	1" X 4-1/2"	3.21
73-139	1-1/2" X 5-1/2"	4.67
73-140	2" X 6"	5.91

BRASS COMPRESSION COUPLING

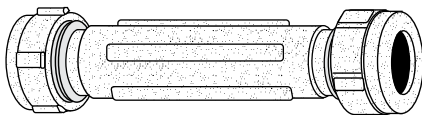

- IPS steel or copper slip x slip coupling

77-193	1/2" CC (3/8" IPS) x 5"	6.05
77-194	3/4" CC (1/2" IPS) x 5"	8.49
77-195	1" CC (3/4" IPS) x 5"	13.54
77-196	1-1/4" CC (1" IPS) x 5"	NEW 14.78
77-197	1-1/2" CC (1-1/4" IPS) x 5"	NEW 20.63
77-198	2" CC (1-3/4" IPS) x 5"	NEW 28.31

GALVANIZED COMPRESSION COUPLING

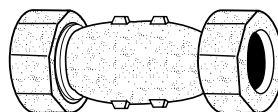

- Slip x Slip coupling

77-125	1/2" x 4-1/2"	7.95
77-124	3/4" x 2-3/4"	NEW 7.57
77-126	3/4" x 4-1/2"	8.67



GALVANIZED SLIP X SLIP COMPRESSION COUPLING LONG STYLE

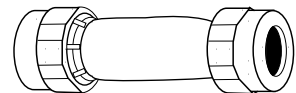

73-125	1/2" x 4-3/8"	23.60
73-126	3/4" x 4-3/8"	23.65
73-127	1" x 4-3/4"	24.82
73-128	1-1/4" x 5-1/8"	31.88
73-129	1-1/2" x 5-3/8"	32.52
73-130	2" x 5-3/4"	41.13

**USE YOUR CREDIT CARD AT TIME OF PURCHASE AND SAVE 2% ON ALL ORDERS,
SAVE 5% ON ALL ORDERS OVER \$500 OR SAVE 10% ON ALL ORDERS OVER \$1000**

**FAX
1-800-982-5934**

www.HODES CO.com
PROFFERED PLUMBING PRODUCTS

**PHONE
1-800-777-6500**



JG John Guest®

HOW TO MAKE A CONNECTION

Fittings and pipe should be kept clean, bagged, and undamaged before use.

TWIST AND LOCK FITTINGS



The fitting should be in the 'unlocked' position. This is shown by a small gap between the screw-cap and the body flange.



Push the pipe into the fitting and up to the pipe stop.



Twist the screw-cap until it touches the body flange. This locks the pipe into position and increases the O-ring seal around the pipe.



Pull to check that it is secure. It is good practice to test the system prior to leaving the site or before use. Our recommended test procedure is shown in our Technical Checklist.

TO DISCONNECT:

Ensure that the system is depressurized.



Be sure to twist the screw-cap back to the unlock position.



Push the collet square against the face of the fitting by using fingers. With the collet held in this position the pipe can be removed. The fitting can be used again without the need for replacement parts. (Ensure the fitting is clean before every use).



The Brands "Speedfit" and "John Guest" are the registered trademarks of John Guest International Limited.

USE YOUR CREDIT CARD AT TIME OF PURCHASE AND SAVE 2% ON ALL ORDERS, SAVE 5% ON ALL ORDERS OVER \$500 OR SAVE 10% ON ALL ORDERS OVER \$1000

SPEEDFIT®



VALVES, FITTINGS, AND PIPE REPAIR

UNION TEE



- Installation time reduced by up to 40%
- No risk of fire or flames from blowtorch
- Easier to work in confined spaces
- A permanent leak-proof connection
- Corrosion free, Lead-free and non-toxic
- Designed for use with Copper, CPVC and PEX
- **Convenient Package Quantities**

Part No.	Size	PKG QTY	Price
72-324	1/4" OD	(10)	2.32
72-325	3/8" OD	(10)	2.82
72-360	1/2" CTS	(5)	4.42
72-361	3/4" CTS	(2)	7.39
72-362	1" CTS	(1)	13.84

REDUCING TEE



- Installation time reduced by up to 40%
- No risk of fire or flames from blowtorch
- Easier to work in confined spaces
- A permanent leak-proof connection
- Corrosion free, Lead-free and non-toxic
- Designed for use with Copper, CPVC and PEX
- **Convenient Package Quantities**

Part No.	Size	PKG QTY	Price
72-329	3/8" x 3/8" x 1/4"	(10)	2.98
72-373	3/4" x 3/4" x 1/2"	(5)	7.01
72-374	3/4" x 1/2" x 1/2"	(5)	6.48
72-375	1/2" x 1/2" x 3/4"	(5)	6.48
72-376	3/4" x 1/2" x 3/4"	(5)	7.01

COUPLER



- Installation time reduced by up to 40%
- No risk of fire or flames from blowtorch
- Easier to work in confined spaces
- A permanent leak-proof connection
- Corrosion free, Lead-free and non-toxic
- Designed for use with Copper, CPVC and PEX
- **Convenient Package Quantities**

Part No.	Size	PKG QTY	Price
72-326	1/4" OD	(10)	1.60
72-327	3/8" OD	(10)	2.17
72-366	1/2" CTS	(5)	3.78
72-367	3/4" CTS	(5)	4.95
72-368	1" CTS	(1)	9.61

REDUCER



- Installation time reduced by up to 40%
- No risk of fire or flames from blowtorch
- Easier to work in confined spaces
- A permanent leak-proof connection
- Corrosion free, Lead-free and non-toxic
- Designed for use with Copper, CPVC and PEX
- **Convenient Package Quantities**

Part No.	Size	PKG QTY	Price
72-328	3/8" Stem x 1/4" Pipe	(10)	1.79
72-369	3/4" Stem x 1/2" Pipe	(10)	2.85
72-370	1" Stem x 3/4" Pipe	(5)	5.63

UNION ELBOW



- Installation time reduced by up to 40%
- No risk of fire or flames from blowtorch
- Easier to work in confined spaces
- A permanent leak-proof connection
- Corrosion free, Lead-free and non-toxic
- Designed for use with Copper, CPVC and PEX
- **Convenient Package Quantities**

Part No.	Size	PKG QTY	Price
72-330	1/4" OD	(10)	1.82
72-331	3/8" OD	(10)	2.78
72-363	1/2" CTS	(5)	4.31
72-364	3/4" CTS	(5)	6.50
72-365	1" CTS	(1)	10.90

STEM ELBOW



- Installation time reduced by up to 40%
- No risk of fire or flames from blowtorch
- Easier to work in confined spaces
- A permanent leak-proof connection
- Corrosion free, Lead-free and non-toxic
- Designed for use with Copper, CPVC and PEX
- **Convenient Package Quantities**

Part No.	Size	PKG QTY	Price
72-371	1/2" Stem x 1/2" Pipe	(10)	3.03
72-372	3/4" Stem x 3/4" Pipe	(5)	4.23

END CAP



- Ideal for temporarily capping of pipes
- Installation time reduced by up to 40%
- No risk of fire or flames from blowtorch
- Easier to work in confined spaces
- A permanent leak-proof connection
- Corrosion free, Lead-free and non-toxic
- Designed for use with Copper, CPVC and PEX
- **Convenient Package Quantities**

Part No.	Size	PKG QTY	Price
72-377	1/2" CTS	(10)	3.09
72-378	3/4" CTS	(10)	3.89
72-379	1" CTS	(5)	6.26

REDUCING UNION



- Installation time reduced by up to 40%
- No risk of fire or flames from blowtorch
- Easier to work in confined spaces
- A permanent leak-proof connection
- Corrosion free, Lead-free and non-toxic
- Designed for use with Copper, CPVC and PEX
- **Convenient Package Quantities**

Part No.	Size	PKG QTY	Price
72-334	3/8" x 1/4"	(10)	2.28

STEM ADAPTER



- Installation time reduced by up to 40%
- No risk of fire or flames from blowtorch
- Easier to work in confined spaces
- A permanent leak-proof connection
- Corrosion free, Lead-free and non-toxic
- Designed for use with Copper, CPVC and PEX
- **Convenient Package Quantities**

Part No.	Size	PKG QTY	Price
72-332	1/4" CTS x 1/4 NPT	(10)	1.19
72-333	3/8" CTS x 3/8 NPT	(10)	2.07

USE YOUR CREDIT CARD AT TIME OF PURCHASE AND SAVE 2% ON ALL ORDERS, SAVE 5% ON ALL ORDERS OVER \$500 OR SAVE 10% ON ALL ORDERS OVER \$1000

FAX 1-800-982-5934 www.HODESCO.com PHONE 1-800-777-6500





**STACKABLE
TEE**



- Installation time reduced by up to 40%
- No risk of fire or flames from blowtorch
- Easier to work in confined spaces
- A permanent leak-proof connection
- Corrosion free, Lead-free and non-toxic
- Designed for use with Copper, CPVC and PEX
- Convenient Package Quantities

	PKG	
	QTY	
72-380	1/2" x 1/2" x 1/2" (5)	5.54
72-381	3/4" x 3/4" x 1/2" (5)	7.24
72-382	3/4" x 3/4" x 3/4" (1)	7.86

**FEMALE
SWIVEL
CONNECTOR**



- Installation time reduced by up to 40%
- No risk of fire or flames from blowtorch
- Easier to work in confined spaces
- A permanent leak-proof connection
- Corrosion free, Lead-free and non-toxic
- Designed for use with Copper, CPVC and PEX
- Convenient Package Quantities

	PKG	
	QTY	
72-384	1/2" CTS x 1/2" NPS (10)	5.15

**FEMALE
SWIVEL
ELBOW**



- Installation time reduced by up to 40%
- No risk of fire or flames from blowtorch
- Easier to work in confined spaces
- A permanent leak-proof connection
- Corrosion free, Lead-free and non-toxic
- Designed for use with Copper, CPVC and PEX
- Convenient Package Quantities

	PKG	
	QTY	
72-383	1/2" CTS x 1/2" NPS (10)	5.15

**BRASS MALE
CONNECTOR**

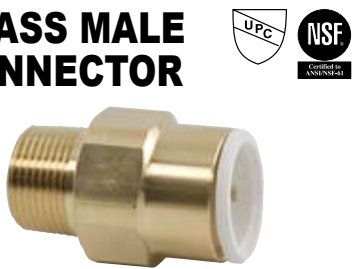

- Installation time reduced by up to 40%
- No risk of fire or flames from blowtorch
- Easier to work in confined spaces
- A permanent leak-proof connection
- Corrosion free, Lead-free and non-toxic
- Designed for use with Copper, CPVC and PEX
- Convenient Package Quantities

	PKG	
	QTY	
72-385	1/2" CTS x 1/2" NPT (5)	10.66
72-386	3/4" CTS x 3/4" NPT (5)	16.00

**BRASS
MALE STEM
ADAPTER**



- Installation time reduced by up to 40%
- No risk of fire or flames from blowtorch
- Easier to work in confined spaces
- A permanent leak-proof connection
- Corrosion free, Lead-free and non-toxic
- Designed for use with Copper, CPVC and PEX
- Convenient Package Quantities

	PKG	
	QTY	
72-387	1/2" CTS x 1/2" NPT (5)	13.89
72-388	3/4" CTS x 3/4" NPT (5)	20.83

**BRASS
FEMALE STEM
ADAPTER**



- Installation time reduced by up to 40%
- No risk of fire or flames from blowtorch
- Easier to work in confined spaces
- A permanent leak-proof connection
- Corrosion free, Lead-free and non-toxic
- Designed for use with Copper, CPVC and PEX
- Convenient Package Quantities

	PKG	
	QTY	
72-389	1/2" CTS x 1/2" NPSM (5)	14.89

**FEMALE
DROP EAR
ELBOW**



- Installation time reduced by up to 40%
- No risk of fire or flames from blowtorch
- Easier to work in confined spaces
- A permanent leak-proof connection
- Corrosion free, Lead-free and non-toxic
- Designed for use with Copper, CPVC and PEX
- Convenient Package Quantities

	PKG	
	QTY	
72-390	1/2" CTS x 1/2" NPT (5)	15.18

The Brands "Speedfit" and "John Guest" are the registered trademarks of John Guest International Limited.

**USE YOUR CREDIT CARD AT TIME OF PURCHASE AND SAVE 2% ON ALL ORDERS,
SAVE 5% ON ALL ORDERS OVER \$500 OR SAVE 10% ON ALL ORDERS OVER \$1000**

SHARKBITE™ FITTINGS



**VALVES,
FITTINGS, AND
PIPE REPAIR**

THE SHARKBITE™ CONNECTION SYSTEM

- SHARKBITE™ Features and Benefits
- Instant push-fit connection for increased ease of use: no soldering required!
- Fittings certified to 200 PSI and 180o F (82o C): proven durability and quality!
- Fits OD controlled copper, CPVC or PEX pipe: versatility with all accepted types of pipe!
- Design certified and agency listed: inspector friendly, peace of mind!
- Compact, robust bronze body: foundation of a strong, durable fitting!
- Design certified to NSF-61 product standard for use in potable water system: quality engineered and manufactured!
- No loose components: integrated design!

• INSTALLATION: 4 EASY STEPS

- STEP ONE: Cut Pipe
- STEP TWO: Deburr pipe
- STEP THREE: Mark pipe
- STEP FOUR: Install pipe to proper depth
• (listen for positive "click")



	PKG QTY	
73-400 1/2" x 1/2"	(12)	8.23
73-401 3/4" x 3/4"	(12)	9.41
73-402 1" x 1"	(12)	18.88

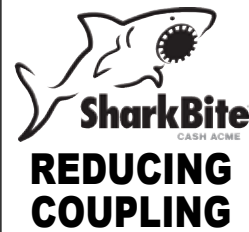

	PKG QTY	
73-403 3/4" x 1/2"	(12)	9.32



	PKG QTY	
73-404 1/2" x 1/2" FIP	(12)	6.14
73-405 3/4" x 3/4" FIP	(6)	7.07
73-406 1" x 1" FIP	(6)	15.19
REDUCING		
73-446 1/2" x 3/4" FIP	(6)	6.27



	PKG QTY	
73-407 1/2" x 1/2" MIP	(12)	6.14
73-408 3/4" x 3/4" MIP	(12)	7.07
73-409 1" x 1" MIP	(12)	15.19
REDUCING		
73-447 1/2" x 3/4" MIP	(12)	6.27
73-448 1" x 3/4" MIP	(12)	12.67



	PKG QTY	
73-410 1/2" x 1/2"	(12)	9.05
73-411 3/4" x 3/4"	(12)	10.59
73-413 3/4" x 1/2"	(6)	11.52
73-449 1" x 1"	(6)	19.93
73-414 1/2" x 1/2" FIP Drop Ear	(6)	7.33

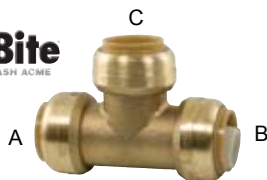

	PKG QTY	
73-415 1/2" x 1/2" x 1/2"	(12)	11.81
73-420 3/4" x 1/2" x 1/2"	(12)	12.81
73-418 3/4" x 3/4" x 1/2"	(12)	13.54
73-419 3/4" x 1/2" x 3/4"	(12)	13.88
73-416 3/4" x 3/4" x 3/4"	(12)	14.19
73-421 1" x 1" x 1"	(12)	23.62
REDUCING		
73-422 1" x 1" x 3/4"	(12)	24.71



	PKG QTY	
73-424 1/2"	(12)	7.51
73-425 3/4"	(6)	9.45
73-426 1"	(6)	18.87



	PKG QTY	
73-430 1/2"	(1)	2.08
73-431 3/4"	(1)	2.08
73-432 1"	(1)	2.26

**USE YOUR CREDIT CARD AT TIME OF PURCHASE AND SAVE 2% ON ALL ORDERS,
SAVE 5% ON ALL ORDERS OVER \$500 OR SAVE 10% ON ALL ORDERS OVER \$1000**

**FAX
1-800-982-5934**

www.HODES CO.com
PROFFERED PLUMBING PRODUCTS

**PHONE
1-800-777-6500**



SHARKBITE™ FITTINGS

THE SHARKBITE™ CONNECTION SYSTEM

- SHARKBITE™ Features and Benefits
- Instant push-fit connection for increased ease of use: no soldering required!
- Fittings certified to 200 PSI and 180o F (82o C): proven durability and quality!
- Fits OD controlled copper, CPVC or PEX pipe: versatility with all accepted types of pipe!
- Design certified and agency listed: inspector friendly, peace of mind!
- Compact, robust bronze body: foundation of a strong, durable fitting!
- Design certified to NSF-61 product standard for use in potable water system: quality engineered and manufactured!
- No loose components: integrated design!

• **INSTALLATION: 4 EASY STEPS**

- STEP ONE: Cut Pipe
- STEP TWO: Deburr pipe
- STEP THREE: Mark pipe
- STEP FOUR: Install pipe to proper depth
 - (listen for positive "click")



DISCONNECTING TONGS



NEW

73-433 1" Disconnecting Tongs **38.65**



SPRING LOADED CHECK



- Can be installed horizontally or vertically
- Max pressure 200 psi
- Max temp 150°F
- Brass Body

NEW

73-434 1/2" Spring Loaded Check **20.47**

73-435 3/4" Spring Loaded Check **24.49**

73-436 3/4" Spring Loaded Check **40.23**



SLIP COUPLING FOR COPPER



- For CTS copper

NEW

73-437 1/2" Slip Coupling **14.06**

73-438 3/4" Slip Coupling **17.24**

73-439 1" Slip Coupling **24.66**



TEE/WATER HAMMER ARRESTOR



- Can be installed horizontally or vertically
- Max pressure 200 psi
- Max temp 200°F
- Brass Body

NEW

73-450 1/2" Tee/Water Hammer Arrestor ... **28.58**



PRESSURE GAUGE



- Dial size 1-1/2"
- Pressure range 0-200psi

NEW

73-476 1/2" Pressure Gauge **23.94**

73-477 3/4" Pressure Gauge **26.15**

73-478 1" Pressure Gauge **42.08**

SHARKBITE™ FITTINGS

HODES CO
PREFERRED PLUMBING PRODUCTS

Case Lot Pricing
available at
www.HodesCo.com

**USE YOUR CREDIT CARD AT TIME OF PURCHASE AND SAVE 2% ON ALL ORDERS,
SAVE 5% ON ALL ORDERS OVER \$500 OR SAVE 10% ON ALL ORDERS OVER \$1000**

FAX 1-800-982-5934 **PHONE 1-800-777-6500**
www.**HODES CO**.com
120 PREFERRED PLUMBING PRODUCTS

PERMALYNX FITTINGS



**VALVES,
FITTINGS, AND
PIPE REPAIR**

Introducing **Permalynx**, a newly-engineered mechanical joining system. It's the fastest copper joining system on earth. Just push and twist to connect copper tube by hand. No flame, no tools required.

Speed to Meet Tight Schedules

Permalynx speed cuts the calendar days needed to finish a job. It gets crews off the job fast and offers a leg up on schedule-crunched projects. At more than 60% faster than sweat, PermaLynx will help get clients into their building in record time - and avoid costly delays.

PERMALYNX COUPLING PL x PL



	PKG QTY	
74-950 1/2" Coupling	(10)	5.27
74-951 3/4" Coupling	(10)	6.77
74-952 1" Coupling	(5)	10.52

PERMALYNX REDUCING COUPLING PL x PL



	PKG QTY	
74-953 3/4" x 1/2" Reducing	(10)	10.52
74-954 1" x 1/2" Reducing	(1)	11.70
74-955 1" x 3/4" Reducing	(5)	11.92

PERMALYNX FEMALE ADAPTER PL x FIP



	PKG QTY	
74-960 1/2" Female	(10)	6.75
74-961 1/2" x 3/4" Female	(5)	7.57
74-962 3/4" Female	(10)	7.34
74-963 3/4" x 1/2" Female	(10)	7.23
74-964 1" Female	(5)	11.60
74-965 1" x 3/4" Female	(1)	16.69

PERMALYNX MALE ADAPTER PL x MIP



	PKG QTY	
74-970 1/2" Male	(10)	6.99
74-971 1/2" x 3/4" Male	(10)	6.28
74-972 3/4" Male	(10)	7.10
74-973 3/4" x 1/2" Male	(10)	7.69
74-974 1" Male	(5)	10.18

PERMALYNX 45° ELBOW PL x PL



	PKG QTY	
74-975 1/2" 45° Elbow	(10)	4.27
74-976 3/4" 45° Elbow	(10)	5.56
74-977 1" 45° Elbow	(5)	10.44

PERMALYNX 90° ELBOW PL x PL



	PKG QTY	
74-981 1/2" 90° Elbow	(10)	5.50
74-982 3/4" 90° Elbow	(10)	5.56
74-983 3/4" x 1/2" 90° Elbow	(10)	8.76
74-984 1" 90° Elbow	(5)	9.92
Drop Elbow		
74-985 1/2" 90° Elbow	(5)	14.20

NEW

PERMALYNX TEE PL x PL x PL



	PKG QTY	
74-990 1/2" Tee	(10)	8.26
74-991 3/4" Tee	(10)	8.83
74-992 1" Tee	(5)	15.76

PERMALYNX REDUCING TEE PL x PL x PL



	PKG QTY	
74-993 1/2" x 1/2" x 3/4" Tee	(10)	13.11
74-994 3/4" x 1/2" x 1/2" Tee	(10)	13.11
74-995 3/4" x 1/2" x 3/4" Tee	(10)	13.11
74-996 3/4" x 3/4" x 1/2" Tee	(10)	13.11
74-997 3/4" x 3/4" x 1" Tee	(5)	20.67
74-998 1" x 1" x 1/2" Tee	(5)	20.67
74-999 1" x 1" x 3/4" Tee	(5)	20.67

PERMALYNX CAP



	PKG QTY	
74-978 1/2" Cap	(10)	5.12
74-979 3/4" Cap	(10)	12.48
74-980 1" Cap	(10)	12.48

**USE YOUR CREDIT CARD AT TIME OF PURCHASE AND SAVE 2% ON ALL ORDERS,
SAVE 5% ON ALL ORDERS OVER \$500 OR SAVE 10% ON ALL ORDERS OVER \$1000**

FAX 1-800-982-5934 www.HODESCO.com PHONE 1-800-777-6500





90° ELBOW



	PKG QTY	
71-601 1/2"	(150)	2.16
71-602 3/4"	(100)	4.15
71-604 1"	(30)	7.19
71-605 1-1/4"	(10)	14.63
71-606 1-1/2"	(10)	27.67
71-607 2"	(5)	38.49

MIP ADAPTER



	PKG QTY	
71-651 1/2"	(100)	2.38
71-652 3/4"	(100)	4.29
71-653 1"	(20)	7.82
71-654 1-1/4"	(10)	17.11
71-655 1-1/2"	(10)	23.99
71-656 2"	(5)	46.19

PRESS FITTINGS

50-YEAR GUARANTEE

PRESS FITTINGS provide a simple, clean and efficient joining method that leaves others in the dust. No more torch, adhesives or fluxes. A specially engineered O'Ring and press fit tool work together to form a watertight seal. Simply applying pressure from the press-fit tool tightens the O'Ring onto the tube, ensuring a perfect fit every time.

Press Fittings from Hodes Co. work with Elkhart or RIDGID pressing tools and jaws.

TEE



	PKG QTY	
71-611 1/2"	(20)	3.29
71-612 3/4"	(20)	5.96
71-613 1"	(10)	10.37
71-614 1-1/4"	(5)	17.52
71-615 1-1/2"	(5)	34.00
71-616 2"	(1)	42.06

**COUPLING
WITH STOP**



• 1-7/8" Length

	PKG QTY	
71-621 1/2"	(100)	1.94
71-622 3/4"	(100)	3.87
71-623 1"	(30)	5.88
71-624 1-1/4"	(5)	7.29
71-625 1-1/2"	(5)	13.62
71-626 2"	(5)	17.40

REDUCER

71-637 3/4" x 1/2"	(10)	8.74
71-638 1" x 3/4"	(10)	10.02

Stock Service System™

Customers Receive

10% OFF

on Every Order!

(regardless of size)

45° ELBOW



	PKG QTY	
71-661 1/2"	(50)	2.46
71-662 3/4"	(50)	3.05
71-663 1"	(30)	9.82
71-664 1-1/4"	(10)	14.01
71-665 1-1/2"	(10)	22.76
71-666 2"	(5)	31.87

FIP ADAPTER



	PKG QTY	
71-641 1/2"	(100)	2.85
71-642 3/4"	(100)	4.60
71-643 1"	(20)	8.49
71-644 1-1/4"	(10)	19.23
71-645 1-1/2"	(10)	27.97
71-646 2"	(5)	47.28

Stock Service System™
Turn Key Inventory Control Program

For more information visit

www.HodesCo.com

Or to discuss further contact:

Joe Hodes

at 816-914-5858(direct line)

or office ext. 1222

joe@HodesCo.com

CAP



	PKG QTY	
71-676 1/2"	(50)	4.13
71-677 3/4"	(50)	6.99
71-678 1"	(10)	10.71
71-679 1-1/4"	(5)	12.11
71-680 1-1/2"	(5)	18.76
71-681 2"	(1)	22.84

**REPAIR COUPLING
LESS STOP**



• 3-5/16" Length

	PKG QTY	
71-631 1/2"	(10)	4.59
71-632 3/4"	(10)	6.30
71-633 1"	(5)	7.74
71-634 1-1/4"	(1)	11.82
71-635 1-1/2"	(1)	18.16
71-636 2"	(1)	21.15

**HONOR
THY
PLUMBER™**

**USE YOUR CREDIT CARD AT TIME OF PURCHASE AND SAVE 2% ON ALL ORDERS,
SAVE 5% ON ALL ORDERS OVER \$500 OR SAVE 10% ON ALL ORDERS OVER \$1000**

**FAX
1-800-982-5934**

www.HODESCO.com



**PHONE
1-800-777-6500**

COPPER FITTINGS



**VALVES,
FITTINGS, AND
PIPE REPAIR**

See www.HodesCo.com
for Case Lot Pricing

WROT COPPER FITTINGS

Our highest quality fittings have been preferred by plumbing professionals for decades. Hodes Co. stocks "ready to ship" copper fittings inventory for immediate delivery and higher fill rates.

90° ELBOW C x C



SOLD IN PACKAGE QUANTITIES ONLY

Item #	Plumbing Nominal I.D.	Refrigeration O.D. Size	Pkg Qty	Case Qty	Price Each
79-098	1/4"	3/8"	25	1200	1.80
79-100	3/8"	1/2"	25	500	1.56
79-101	1/2"	5/8"	100	500	.42¢
79-099	5/8"	3/4"	5	300	3.55
79-102	3/4"	7/8"	25	250	.94¢
79-104	1"	1-1/8"	10	100	2.36
79-105	1-1/4"	1-3/8"	10	100	4.49
79-106	1-1/2"	1-5/8"	5	50	7.03
79-107	2"	2-1/8"	3	30	11.61

90° REDUCING ELBOW C x C



SOLD IN PACKAGE QUANTITIES ONLY

Item #	Plumbing Nominal I.D.	Refrigeration O.D. Size	Pkg Qty	Case Qty	Price Each
79-103	3/4" x 1/2"	7/8" x 5/8"	25	200	3.03
79-109	1" x 3/4"	1-1/8" x 7/8"	10	80	5.80
79-013	1-1/4" x 1"	1-3/8" x 1-1/8"	5	35	18.88

90° STREET ELBOW FTG x C



SOLD IN PACKAGE QUANTITIES ONLY

Item #	Plumbing Nominal I.D.	Refrigeration O.D. Size	Pkg Qty	Case Qty	Price Each
79-110	3/8"	1/2"	25	500	2.01
79-111	1/2"	5/8"	25	500	.57¢
79-090	5/8"	3/4"	5	100	3.91
79-112	3/4"	7/8"	25	250	1.38
79-113	1"	1-1/8"	10	200	3.34
79-119	1-1/4"	1-3/8"	5	50	6.91
79-123	1-1/2"	1-5/8"	5	40	9.47
79-124	2"	2-1/8"	1	17	20.60

90° FLANGED ELBOW



SOLD IN PACKAGE QUANTITIES ONLY

Item #	Plumbing Nominal I.D.	Refrigeration O.D. Size	Pkg Qty	Case Qty	Price Each
79-141	1/2"	5/8"	5	25	8.20

90° LONG RADIUS ELBOW C x C



SOLD IN PACKAGE QUANTITIES ONLY

Item #	Plumbing Nominal I.D.	Refrigeration O.D. Size	Pkg Qty	Case Qty	Price Each
79-114	1/2"	5/8"	25	350	2.36
79-115	3/4"	7/8"	10	120	2.71
79-150	1"	1-1/8"	10	60	6.94
79-151	1-1/4"	1-3/8"	5	35	11.08
79-152	1-1/2"	1-5/8"	5	25	14.86
79-153	2"	2-1/8"	1	12	39.07
79-154	2-1/2"	2-5/8"	1	16	61.88
79-155	3"	3-1/8"	1	8	87.17

90° DROP EAR ELBOW C x FIP



SOLD IN PACKAGE QUANTITIES ONLY

Item #	Plumbing Nominal I.D.	Refrigeration O.D. Size	Pkg Qty	Case Qty	Price Each
71-139	1/2" x 1/2"	5/8"	25	300	1.99

90° DROP EAR ELBOW C x C



SOLD IN PACKAGE QUANTITIES ONLY

Item #	Plumbing Nominal I.D.	Refrigeration O.D. Size	Pkg Qty	Case Qty	Price Each
79-149	1/2"	5/8"	5	25	3.78

90° ELBOW C x MIP



SOLD IN PACKAGE QUANTITIES ONLY

Item #	Plumbing Nominal I.D.	Refrigeration O.D. Size	Pkg Qty	Case Qty	Price Each
79-144	1/2"	5/8"	5	25	3.63
79-145	3/4"	7/8"	5	25	6.52
79-146	1"	1-1/8"	5	25	11.50

90° ELBOW C x FIP



SOLD IN PACKAGE QUANTITIES ONLY

Item #	Plumbing Nominal I.D.	Refrigeration O.D. Size	Pkg Qty	Case Qty	Price Each
79-130	1/2"	5/8"	5	25	3.01
79-133	3/4"	7/8"	5	25	5.13

90° VENT ELBOW C x C



SOLD IN PACKAGE QUANTITIES ONLY

Item #	Plumbing Nominal I.D.	Refrigeration O.D. Size	Pkg Qty	Case Qty	Price Each
79-012	3/4"	7/8"	5	25	6.82

USE YOUR CREDIT CARD AT TIME OF PURCHASE AND **SAVE 2% ON ALL ORDERS,**
SAVE 5% ON ALL ORDERS OVER \$500 OR SAVE 10% ON ALL ORDERS OVER \$1000

FAX
1-800-982-5934

www. **HODES CO.** .com
PREFERRED PLUMBING PRODUCTS

PHONE
1-800-777-6500



**45° ELBOW
C x C**



SOLD IN PACKAGE QUANTITIES ONLY

Item #	Plumbing Nominal I.D.	Refrigeration O.D. Size	Pkg Qty	Case Qty	Price Each
79-108	1/4"	3/8"	25	400	2.81
79-116	1/2"	5/8"	25	500	.71¢
79-092	5/8"	3/4"	5	25	5.70
79-117	3/4"	7/8"	25	250	1.22
79-118	1"	1-1/8"	10	200	4.06
79-125	1-1/4"	1-3/8"	5	60	6.22
79-126	1-1/2"	1-5/8"	5	40	6.85
79-127	2"	2-1/8"	3	18	14.19

**45° STREET ELBOW
FTG x C**



SOLD IN PACKAGE QUANTITIES ONLY

Item #	Plumbing Nominal I.D.	Refrigeration O.D. Size	Pkg Qty	Case Qty	Price Each
79-120	1/2"	5/8"	25	500	.80¢
79-091	5/8"	3/4"	5	25	8.63
79-121	3/4"	7/8"	25	250	1.23
79-122	1"	1-1/8"	10	200	5.62
79-128	1-1/4"	1-3/8"	5	60	7.66
79-129	1-1/2"	1-5/8"	5	40	9.35
79-132	2"	2-1/8"	1	30	14.13

**COUPLING
WITHOUT STOP
C x C**



SOLD IN PACKAGE QUANTITIES ONLY

Item #	Plumbing Nominal I.D.	Refrigeration O.D. Size	Pkg Qty	Case Qty	Price Each
79-400	1/4"	3/8"	25	2000	.44¢
79-420	1/2"	5/8"	25	500	.46¢
79-399	5/8"	3/4"	25	400	1.57
79-421	3/4"	7/8"	25	500	1.08
79-422	1"	1-1/8"	10	150	2.39
79-423	1-1/4"	1-3/8"	5	100	3.78
79-424	1-1/2"	1-5/8"	5	60	5.09
79-425	2"	2-1/8"	4	40	8.61

**COUPLING WITH
ROLLED STOP
C x C**



SOLD IN PACKAGE QUANTITIES ONLY

Item #	Plumbing Nominal I.D.	Refrigeration O.D. Size	Pkg Qty	Case Qty	Price Each
79-401	1/2"	5/8"	25	500	.35¢
79-402	3/4"	7/8"	25	500	.82¢
79-403	1"	1-1/8"	10	250	1.65
79-410	1-1/4"	1-3/8"	10	150	3.07
79-411	1-1/2"	1-5/8"	10	100	4.06
79-412	2"	2-1/8"	1	40	6.79

**REDUCING COUPLING
C x C**



SOLD IN PACKAGE QUANTITIES ONLY

Item #	Plumbing Nominal I.D.	Refrigeration O.D. Size	Pkg Qty	Case Qty	Price Each
79-406	1/2" x 1/4"	5/8" x 1/2"	25	800	1.01
79-407	1/2" x 3/8"	5/8" x 1/2"	25	800	.94¢
79-419	3/4" x 1/4"	7/8" x 3/8"	25	500	1.90
79-408	3/4" x 1/2"	7/8" x 5/8"	10	500	1.44
79-093	3/4" x 5/8"	7/8" x 3/4"	10	100	1.70
79-409	1" x 3/4"	1-1/8" x 7/8"	10	250	2.68
79-414	1-1/4" x 3/4"	1-3/8" x 7/8"	5	100	3.99
79-415	1-1/4" x 1"	1-3/8" x 1-1/8"	5	100	3.99
79-417	1-1/2" x 1-1/4"	1-5/8" x 1-3/8"	5	100	6.62
79-426	2" x 1"	2-1/8" x 1-1/8"	5	100	10.79
79-416	2" x 1-1/4"	2-1/8" x 1-3/8"	5	100	10.22
79-418	2" x 1-1/2"	2-1/8" x 1-5/8"	5	50	10.22

**COUPLING
WITH DRAIN
C x C**



SOLD IN PACKAGE QUANTITIES ONLY

Item #	Plumbing Nominal I.D.	Refrigeration O.D. Size	Pkg Qty	Case Qty	Price Each
79-160	1/2"	5/8"	5	25	4.55
79-161	3/4"	7/8"	5	25	5.99

**DROP EAR
ADAPTER C x F**



SOLD IN PACKAGE QUANTITIES ONLY

Item #	Plumbing Nominal I.D.	Refrigeration O.D. Size	Pkg Qty	Case Qty	Price Each
79-135	1/2"	5/8"	5	50	10.44

**TUBE CAP
C**



SOLD IN PACKAGE QUANTITIES ONLY

Item #	Plumbing Nominal I.D.	Refrigeration O.D. Size	Pkg Qty	Case Qty	Price Each
79-476	1/2" C	5/8" C	25	1400	.35¢
79-477	3/4" C	7/8" C	25	550	.71¢
79-478	1" C	1-1/8" C	10	300	1.51
79-479	1-1/4" C	1-3/8" C	1	200	2.45
79-480	1-1/2" C	1-5/8" C	1	140	3.58
79-481	2" C	2-1/8" C	1	60	6.60

**USE YOUR CREDIT CARD AT TIME OF PURCHASE AND SAVE 2% ON ALL ORDERS,
SAVE 5% ON ALL ORDERS OVER \$500 OR SAVE 10% ON ALL ORDERS OVER \$1000**

COPPER FITTINGS

See www.HodesCo.com
for Case Lot Pricing



**VALVES,
FITTINGS, AND
PIPE REPAIR**

TEE C x C x C

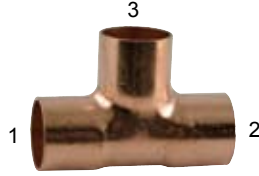

SOLD IN PACKAGE QUANTITIES ONLY

Item #	Plumbing Nominal I.D.	Refrigeration O.D. Size	Pkg Qty	Case Qty	Price Each
79-201	1/2"	5/8"	50	500	.80¢
79-204	3/4"	7/8"	20	200	1.91
79-210	1"	1-1/8"	10	100	6.23
79-215	1-1/4"	1-3/8"	5	35	9.16
79-216	1-1/2"	1-5/8"	5	20	15.32
79-217	2"	2-1/8"	1	10	22.75
79-262	3"	2-7/8"	1	2	66.84
79-263	4"	3-7/8"	1	2	161.73
79-202	1/2" x 1/2" x 3/4"	5/8" x 5/8" x 7/8"	10	180	4.32
79-205	3/4" x 3/4" x 1/2"	7/8" x 7/8" x 5/8"	10	200	2.09
79-206	3/4" x 1/2" x 3/4"	7/8" x 5/8" x 7/8"	10	200	2.64
79-207	3/4" x 1/2" x 1/2"	7/8" x 5/8" x 5/8"	10	200	2.36
79-227	3/4" x 3/4" x 1"	7/8" x 7/8" x 1-1/8"	10	80	7.54
79-208	1" x 1/2" x 1/2"	1-1/8" x 5/8" x 5/8"	10	100	8.64
79-209	1" x 1" x 1/2"	1-1/8" x 1-1/8" x 5/8"	10	100	6.72
79-211	1" x 1" x 3/4"	1-1/8" x 1-1/8" x 7/8"	10	100	7.18
79-212	1" x 3/4" x 1"	1-1/8" x 7/8" x 1-1/8"	10	60	7.80
79-213	1" x 3/4" x 3/4"	1-1/8" x 7/8" x 7/8"	5	60	8.28
79-228	1-1/4" x 1/2" x 1/2"	1-3/8" x 5/8" x 5/8"	5	50	16.38
79-223	1-1/4" x 3/4" x 3/4"	1-3/8" x 7/8" x 7/8"	5	50	13.13
79-251	1-1/4" x 3/4" x 1-1/4"	1-3/8" x 7/8" x 1-3/8"	1	35	14.05
79-255	1-1/4" x 1" x 3/4"	1-3/8" x 1-1/8" x 7/8"	1	50	14.05
79-250	1-1/4" x 1" x 1"	1-3/8" x 1-1/8" x 1-1/8"	1	50	14.05
79-261	1-1/4" x 1" x 1-1/4"	1-3/8" x 1-1/8" x 1-3/8"	1	30	14.38
79-233	1-1/4" x 1-1/4" x 1/2"	1-3/8" x 1-3/8" x 5/8"	5	50	10.71
79-234	1-1/4" x 1-1/4" x 3/4"	1-3/8" x 1-3/8" x 7/8"	5	50	10.71
79-224	1-1/4" x 1-1/4" x 1"	1-3/8" x 1-3/8" x 1-1/8"	5	50	9.95
79-242	1-1/2" x 3/4" x 1-1/4"	1-5/8" x 7/8" x 1-3/8"	2	30	27.16
79-252	1-1/2" x 1" x 3/4"	1-5/8" x 1-1/8" x 7/8"	1	30	23.76
79-243	1-1/2" x 1" x 1"	1-5/8" x 1-1/8" x 1-1/8"	2	35	22.09
79-219	1-1/2" x 1" x 1-1/4"	1-5/8" x 1-1/8" x 1-3/8"	2	30	29.37
79-258	1-1/2" x 1-1/4" x 3/4"	1-5/8" x 1-3/8" x 7/8"	1	40	23.76
79-218	1-1/2" x 1-1/2" x 1/2"	1-3/8" x 1-3/8" x 3/8"	5	100	10.60
79-222	1-1/2" x 1-1/2" x 1-1/4"	1-5/8" x 1-5/8" x 1-3/8"	5	25	11.36
79-221	1-1/2" x 1-1/2" x 3/4"	1-5/8" x 1-5/8" x 7/8"	5	35	11.36
79-220	1-1/2" x 1-1/2" x 1"	1-5/8" x 1-5/8" x 1-1/8"	5	35	11.36
79-259	2" x 1-1/4" x 1-1/2"	2-1/8" x 1-3/8" x 1-5/8"	1	15	40.65
79-249	2" x 1-1/2" x 1"	2-1/8" x 1-5/8" x 1-1/8"	1	20	31.65
79-248	2" x 2" x 3/4"	2-1/8" x 2-1/8" x 7/8"	1	20	17.97
79-245	2" x 2" x 1"	2-1/8" x 2-1/8" x 1-1/8"	3	18	18.54
79-246	2" x 2" x 1-1/4"	2-1/8" x 2-1/8" x 1-3/8"	3	15	20.56
79-247	2" x 2" x 1-1/2"	2-1/8" x 2-1/8" x 1-5/8"	2	10	18.54
79-256	2-1/2" x 1-1/4" x 2-1/2"	2-5/8" x 1-3/8" x 2-5/8"	1	15	97.54
79-257	2-1/2" x 2" x 1-1/2"	2-5/8" x 2-1/8" x 1-5/8"	1	20	74.23
79-254	3" x 1" x 3"	3-1/8" x 1-1/8" x 3-1/8"	1	10	137.57
79-260	3" x 2" x 2-1/2"	3-1/8" x 2-1/8" x 2-5/8"	1	10	137.20
79-253	3" x 3" x 2-1/2"	3-1/8" x 3-1/8" x 2-5/8"	1	10	68.99

TEE C x F x C



SOLD IN PACKAGE QUANTITIES ONLY

Item #	Plumbing Nominal I.D.	Refrigeration O.D. Size	Pkg Qty	Case Qty	Price Each
79-230	1/2"	5/8"	5	25	5.56
79-231	3/4"	7/8"	5	25	10.60

TEE C x C x F



SOLD IN PACKAGE QUANTITIES ONLY

Item #	Plumbing Nominal I.D.	Refrigeration O.D. Size	Pkg Qty	Case Qty	Price Each
79-225	1/2"	5/8"	5	25	5.81
79-232	1/2" x 1/2" x 3/4"	5/8" x 5/8" x 7/8"	5	25	9.73
79-226	3/4"	7/8"	5	25	9.40
79-235	3/4" x 3/4" x 1/2"	7/8" x 7/8" x 1/2"	5	25	9.85
79-236	1"	1-1/8"	5	10	22.00
79-229	1" x 1" x 3/4"	1-1/8" x 1-1/8" x 7/8"	5	10	16.17

UNION C x C

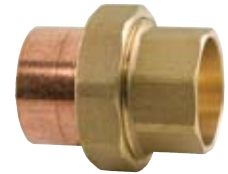

SOLD IN PACKAGE QUANTITIES ONLY

Item #	Plumbing Nominal I.D.	Pkg Qty	Case Qty	Price Each
79-490	1/2"	5	250	5.96
79-491	3/4"	5	200	7.96
79-492	1"	3	90	13.69
79-493	1-1/4"	3	45	22.24
79-494	1-1/2"	2	12	29.29
79-495	2"	1	33	49.93

FITTING REDUCER FTG x C



SOLD IN PACKAGE QUANTITIES ONLY

Item #	Plumbing Nominal I.D.	Refrigeration O.D. Size	Pkg Qty	Case Qty	Price Each
79-433	3/4" x 1/2"	7/8" x 5/8"	25	400	1.52
79-434	1" x 3/4"	1-1/8" x 7/8"	10	160	2.86
79-441	1" x 1/2"	1-1/8" x 5/8"	10	200	3.16
79-435	1-1/4" x 1"	1-3/8" x 1-1/8"	5	100	3.86
79-440	1-1/2" x 3/4"	2-5/8" x 7/8"	1	100	5.83
79-439	1-1/2" x 1"	2-5/8" x 1-1/8"	1	100	5.83
79-438	2" x 3/4"	2-1/8" x 7/8"	1	50	11.52
79-437	2" x 1"	2-1/8" x 1-1/8"	1	50	11.52
79-436	2" x 1-1/2"	2-1/8" x 1-5/8"	1	50	10.71

**USE YOUR CREDIT CARD AT TIME OF PURCHASE AND SAVE 2% ON ALL ORDERS,
SAVE 5% ON ALL ORDERS OVER \$500 OR SAVE 10% ON ALL ORDERS OVER \$1000**

FAX 1-800-982-5934 www.HODESCO.com PHONE 1-800-777-6500





**ADAPTOR
C x FIP**



SOLD IN PACKAGE QUANTITIES ONLY

Item #	Plumbing Nominal I.D.	Refrigeration O.D. Size	Pkg Qty	Case Qty	Price Each
79-350	3/8"	1/2"	10	800	3.79
79-351	1/2"	5/8"	25	500	1.61
79-352	3/4"	7/8"	25	250	2.06
79-353	1"	1-1/8"	10	200	6.00
79-358	1-1/4"	1-3/8"	5	60	8.78
79-359	1-1/2"	1-5/8"	1	60	13.13
79-360	2"	2-1/8"	1	30	17.85

**REDUCING ADAPTOR
C x FIP**



SOLD IN PACKAGE QUANTITIES ONLY

Item #	Plumbing Nominal I.D.	Refrigeration O.D. Size	Pkg Qty	Case Qty	Price Each
79-354	3/8" x 1/2"	1/2" x 5/8"	10	500	2.80
79-355	1/2" x 3/4"	5/8" x 7/8"	25	250	3.82
79-356	1/2" x 3/8"	5/8" x 1/2"	10	500	3.24
79-357	3/4" x 1/2"	7/8" x 5/8"	10	250	3.82
79-365	3/4" x 1"	7/8" x 1-1/8"	10	10	8.02
79-364	1" x 3/4"	1-1/8" x 7/8"	10	10	8.02
79-363	1-1/2" x 1-1/4"	1-5/8" x 1-3/8"	5	10	18.61

**ADAPTOR
FTG x MIP**

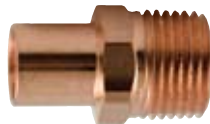

SOLD IN PACKAGE QUANTITIES ONLY

Item #	Plumbing Nominal I.D.	Refrigeration O.D. Size	Pkg Qty	Case Qty	Price Each
79-313	1/2"	5/8"	10	500	4.88
79-314	3/4"	7/8"	10	250	6.23

EXTRA LONG COUPLING



BOX
QTY

71-426	1/2" x 12"	(100)	4.55
71-427	3/4" x 12"	(100)	6.17

**ADAPTOR
FTG x FIP**

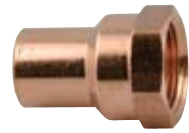

SOLD IN PACKAGE QUANTITIES ONLY

Item #	Plumbing Nominal I.D.	Refrigeration O.D. Size	Pkg Qty	Case Qty	Price Each
79-361	1/2"	5/8"	10	500	3.61
79-362	3/4"	7/8"	1	250	4.66

**ADAPTOR
C x MIP**

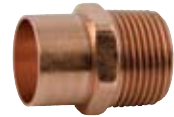

SOLD IN PACKAGE QUANTITIES ONLY

Item #	Plumbing Nominal I.D.	Refrigeration O.D. Size	Pkg Qty	Case Qty	Price Each
79-300	3/8"	1/2"	5	1000	2.72
79-301	1/2"	5/8"	25	500	1.02
79-302	3/4"	7/8"	25	250	1.90
79-303	1"	1-1/8"	10	200	4.92
79-308	1-1/4"	1-3/8"	5	90	7.68
79-309	1-1/2"	1-5/8"	2	64	10.31
79-310	2"	2-1/8"	2	35	19.51

**REDUCING ADAPTOR
C x MIP**



SOLD IN PACKAGE QUANTITIES ONLY

Item #	Plumbing Nominal I.D.	Refrigeration O.D. Size	Pkg Qty	Case Qty	Price Each
79-307	1/4" x 1/2"	3/8" x 5/8"	10	500	4.87
79-011	3/4" x 1/2"	7/8" x 5/8"	10	250	4.71
79-305	1/2" x 3/4"	5/8" x 7/8"	10	250	4.71
79-304	3/8" x 1/2"	1/2" x 5/8"	10	500	4.71
79-306	1/2" x 3/8"	5/8" x 1/2"	10	700	3.54
79-311	1" x 3/4"	1-1/8" x 7/8"	5	150	7.32
79-312	3/4" x 1"	7/8" x 1-1/8"	5	150	7.66
79-316	1-1/4" x 1"	1-3/8" x 1-1/8"	5	10	10.42
79-315	1-1/2" x 1-1/4"	1-5/8" x 1-3/8"	5	10	16.22

REPAIR COUPLING

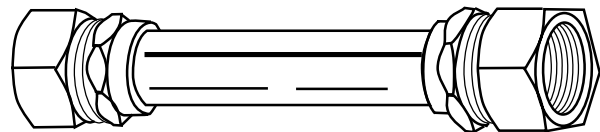

Extra long, solid BRASS and COPPER coupling body with no stops inside the compression fittings to allow a "FULL SLIP" on any 1/2" nom. (5/8" OD) tube. Provides easy freeze damage repairs

71-428	6" x 5/8" OD x 5/8" OD	11.66
--------	------------------------	-------

USE YOUR CREDIT CARD AT TIME OF PURCHASE AND SAVE 2% ON ALL ORDERS, SAVE 5% ON ALL ORDERS OVER \$500 OR SAVE 10% ON ALL ORDERS OVER \$1000

DWV COPPER FITTINGS



**VALVES,
FITTINGS, AND
PIPE REPAIR**

90° DWV ELBOW C x C



See www.HodesCo.com
for Case Lot Pricing

NEW

Item #	DWV I.D.	Pkg Qty	Case Qty	Price Ea.
79-776	1-1/4"	20	120	6.65
79-710	1-1/2"	10	100	9.95
79-711	2"	5	50	12.98
79-712	3"	2	16	32.13
79-713	4"	2	8	156.87
79-764	2" x 1-1/2"	5	50	35.79

60° DWV ELBOW C x C



NEW

Item #	DWV I.D.	Pkg Qty	Case Qty	Price Ea.
79-779	1-1/4"	20	100	11.88
79-780	1-1/2"	10	120	12.00
79-781	2"	2	80	22.53

45° DWV STREET ELBOW C x FTG



NEW

Item #	DWV I.D.	Pkg Qty	Case Qty	Price Ea.
79-775	1-1/4"	20	120	9.41
79-722	1-1/2"	10	100	7.08
79-723	2"	5	50	14.45
79-724	3"	2	20	34.73
79-725	4"	2	16	66.67

11-1/4° DWV ELBOW C x C



NEW

Item #	DWV I.D.	Pkg Qty	Case Qty	Price Ea.
79-729	1-1/2"	10	100	14.18
79-730	2"	5	50	18.33
79-731	3"	2	20	32.00

DWV DOUBLE SANITARY TEE C x C x C



NEW

Item #	DWV I.D.	Pkg Qty	Case Qty	Price Ea.
79-792	1-1/4"	2	50	38.54
79-740	1-1/2"	2	50	31.78
79-741	2"	2	25	73.25
79-793	1-1/2" x 1-1/4"	2	50	45.27
79-794	2" x 1-1/4"	2	25	81.55
79-743	2" x 1-1/2" x 1-1/2" x 1-1/2"	2	25	122.48
79-742	2" x 2" x 1-1/2" x 1-1/2"	2	25	65.62

90° DWV STREET ELBOW C x FTG



NEW

Item #	DWV I.D.	Pkg Qty	Case Qty	Price Ea.
79-778	1-1/4"	20	100	8.72
79-714	1-1/2"	10	100	9.23
79-715	2"	5	50	17.92
79-716	3"	2	16	38.91
79-717	4"	2	8	156.87

45° DWV ELBOW C x C



NEW

Item #	DWV I.D.	Pkg Qty	Case Qty	Price Ea.
79-774	1-1/4"	20	200	6.11
79-718	1-1/2"	10	100	5.56
79-719	2"	5	50	11.63
79-720	3"	2	20	24.68
79-721	4"	2	16	107.86

22-1/2° DWV ELBOW C x C



NEW

Item #	DWV I.D.	Pkg Qty	Case Qty	Price Ea.
79-777	1-1/4"	20	200	12.66
79-726	1-1/2"	10	100	14.93
79-727	2"	5	50	19.29
79-728	3"	2	20	33.69

DWV SANITARY TEE C x C x C



NEW

Item #	DWV I.D.	Pkg Qty	Case Qty	Price Ea.
79-782	1-1/4"	10	100	13.13
79-736	1-1/2"	10	80	16.33
79-737	2"	5	40	22.61
79-738	3"	2	16	70.43
79-739	4"	2	8	269.17
79-784	1-1/2" x 1-1/4" x 1-1/4"	10	45	38.34
79-783	1-1/2" x 1-1/4" x 1-1/2"	10	80	38.34
79-785	1-1/2" x 1-1/2" x 1-1/4"	10	90	19.56
79-788	2" x 1-1/2" x 1-1/4"	10	50	30.40
79-761	2" x 1-1/2" x 1-1/2"	2	40	30.41
79-787	2" x 1-1/2" x 2"	10	40	31.05
79-786	2" x 2" x 1-1/4"	10	40	19.71
79-752	2" x 2" x 1-1/2"	2	40	17.98
79-791	3" x 1-1/2" x 1-1/4"	10	30	61.90
79-790	3" x 3" x 1-1/4"	2	20	54.56
79-789	3" x 3" x 1-1/2"	2	30	54.56
79-760	3" x 3" x 2"	10	13	54.57

**USE YOUR CREDIT CARD AT TIME OF PURCHASE AND SAVE 2% ON ALL ORDERS,
SAVE 5% ON ALL ORDERS OVER \$500 OR SAVE 10% ON ALL ORDERS OVER \$1000**

FAX 1-800-982-5934 www.HODESCO.com PHONE 1-800-777-6500





DWV COPPER FITTINGS

DWV COUPLING W/STOP C x C



See www.HodesCo.com
for Case Lot Pricing

NEW

Item #	DWV I.D.	Pkg Qty	Case Qty	Price Ea.
79-699	1-1/4"	25	300	3.12
79-700	1-1/2"	25	250	3.87
79-701	2"	10	100	5.36
79-702	3"	5	50	10.40
79-703	4"	2	20	33.07

DWV REDUCING COUPLING C x C



NEW

Item #	DWV I.D.	Pkg Qty	Case Qty	Price Ea.
79-767	1-1/2" x 1-1/4"	25	300	6.28
79-768	2" x 1-1/4"	10	150	5.88
79-704	2" x 1-1/2"	10	100	7.25
79-769	3" x 1-1/2"	5	100	26.26
79-705	3" x 2"	5	20	24.56

DWV ADAPTER C x MIP



NEW

Item #	DWV I.D.	Pkg Qty	Case Qty	Price Ea.
79-803	1-1/4"	25	300	9.58
79-748	1-1/2"	10	100	10.67
79-749	2"	10	100	13.52
79-750	3"	5	36	63.79
79-751	4"	5	20	160.70

DWV Y



NEW

Item #	DWV I.D.	Pkg Qty	Case Qty	Price Ea.
79-796	1-1/4"	5	70	25.92
79-732	1-1/2"	5	70	28.23
79-733	2"	2	40	36.69
79-734	3"	2	12	88.67
79-735	4"	2	5	263.82
79-798	1-1/2" x 1-1/4" x 1-1/4"	5	45	32.56
79-797	1-1/2" x 1-1/4" x 1-1/2"	5	80	32.56
79-799	1-1/2" x 1-1/2" x 1-1/4"	5	80	32.56
79-756	2" x 1-1/2" x 1-1/2"	2	50	40.88
79-757	2" x 1-1/2" x 2"	2	40	45.42
79-800	2" x 2" x 1-1/4"	5	50	45.42
79-755	2" x 2" x 1-1/2"	2	50	39.05
79-759	3" x 3" x 2"	2	20	80.66
79-801	3" x 3" x 1-1/2"	5	30	80.65

DWV COUPLING C x C



NEW

Item #	DWV I.D.	Pkg Qty	Case Qty	Price Ea.
79-706	1-1/2"	25	250	3.87
79-707	2"	10	100	5.36
79-708	3"	5	50	10.40
79-709	4"	2	20	33.07

DWV BUSHING FITTING x C



NEW

Item #	DWV I.D.	Pkg Qty	Case Qty	Price Ea.
79-770	1-1/2" FTG x 1-1/4" C	10	300	5.88
79-771	2" FTG x 1-1/4" C	10	100	7.08
79-763	2" FTG x 1-1/2" C	10	50	6.41
79-773	3" FTG x 1-1/2" C	5	80	36.04
79-772	3" FTG x 2" C	5	100	32.26

DWV ADAPTER C x FIP



NEW

Item #	DWV I.D.	Pkg Qty	Case Qty	Price Ea.
79-802	1-1/4"	25	200	9.08
79-744	1-1/2"	10	100	8.72
79-745	2"	10	100	16.28
79-746	3"	5	28	107.01
79-747	4"	2	20	183.77

DWV FLUSH CLEANOUT W/PLUG



NEW

Item #	DWV I.D.	Pkg Qty	Case Qty	Price Ea.
79-753	1-1/2"	2	120	18.16
79-754	2"	2	75	21.78
79-762	3"	2	50	46.13

DWV P-TRAP



NEW

Item #	DWV I.D.	Pkg Qty	Case Qty	Price Ea.
50-350	1-1/2"	10	50	45.96
50-353	1-1/2" w/Cleanout	2	50	51.15
50-351	2"	5	25	71.01
50-352	3"	2	10	264.80

DWV DOUBLE Y



NEW

Item #	DWV I.D.	Pkg Qty	Case Qty	Price Ea.
79-765	1-1/2"	2	35	44.59
79-758	2" x 1-1/2"	2	40	66.40
79-766	2"	2	25	79.00

**USE YOUR CREDIT CARD AT TIME OF PURCHASE AND SAVE 2% ON ALL ORDERS,
SAVE 5% ON ALL ORDERS OVER \$500 OR SAVE 10% ON ALL ORDERS OVER \$1000**

INSERT FITTINGS FOR POLYBUTYLENE



**VALVES,
FITTINGS, AND
PIPE REPAIR**

COPPER CRIMP RING

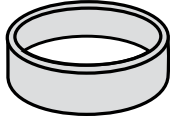

SOLD IN PACKAGES OF 25 ONLY

73-444 1/2" **.35¢**
73-445 3/4" **.46¢**

COPPER INSERT MALE ADAPTER BARB X MPT

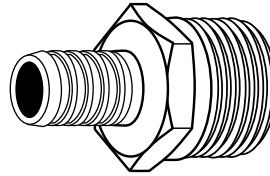

		PKG QTY	
73-470	1/2" x 1/2"	(25)	6.20
73-471	3/4" x 3/4"	(25)	7.53

BARBED ELBOW BRASS BARB X BARB

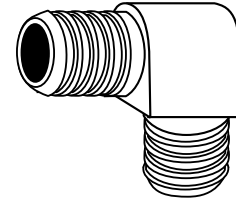

		PKG QTY	
73-458	1/2" x 1/2"	(25)	2.34
73-459	3/4" x 3/4"	(25)	3.19

BARBED COPPER INSERT TEE

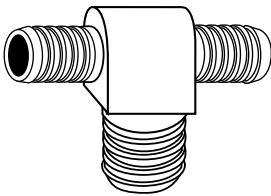

		PKG QTY	
73-451	1/2"	(25)	3.53

BARBED COPPER INSERT COUPLING BARB X BARB



		PKG QTY	
73-462	1/2" x 1/2"	(25)	1.17
73-464	3/4" x 3/4"	(25)	1.65

GALVINIZED VENTURI MALE ADAPTER



- Zinc plated
- For flexible polyethylene plastic pipe

		PKG QTY	
73-944	1" x 10"	(25)	9.61

NEW

MALE COPPER INSERT COUPLING

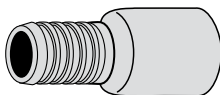

		PKG QTY	
73-472	1/2" x 1/2"	(25)	1.53
73-473	3/4" x 3/4"	(25)	2.68
FEMALE SWEAT x BARB			
73-474	1/2" x 1/2"	(25)	1.53
73-475	3/4" x 3/4"	(25)	2.68

BRASS INSERT MALE ADAPTER

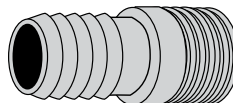

		PKG QTY	
73-937	3/4"	(12)	6.48
73-938	1"	(12)	8.46

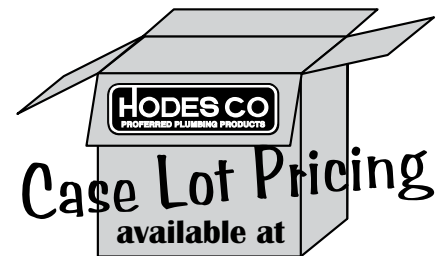

www.HodesCo.com

**USE YOUR CREDIT CARD AT TIME OF PURCHASE AND SAVE 2% ON ALL ORDERS,
SAVE 5% ON ALL ORDERS OVER \$500 OR SAVE 10% ON ALL ORDERS OVER \$1000**

FAX 1-800-982-5934 www.HODESCO.com PHONE 1-800-777-6500





POLY/BRASS FLARE FITTINGS

FEMALE ADAPTER TUBE X FIP

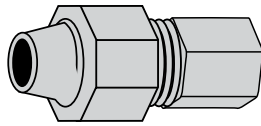

- Ideal for remodeling and repair jobs
- Works with copper, CPVC, Polybutylene and Pex
- Standards/approvals: ASTM, BOCA, CSA, HUD, HUD/FHA, MHI, MSS, NFPA, PHCC, RVI, SBCCI, UL

	PKG QTY	
73-370	1/2" x 1/2" FPT (25)	4.29
73-371	1/2" x 3/4" FPT (25) NEW	4.74
73-372	3/4" x 3/4" FPT (25)	6.39

POLY FEMALE ELBOW ADAPTER

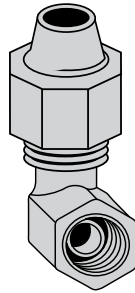

25 PER BAG

73-331	1/2" ID x 1/2" FPT	5.88
--------	--------------------	------

ADD-A-LINE FULL-SLIP BALL VALVE TEE

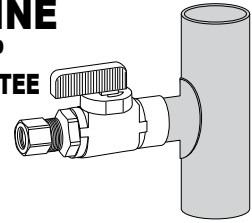

- Female sweat trunks, brazed saddle branches - no worries when soldering
- Adding water lines has never been easier, perfect for adding humidifiers, dishwashers, ice makers or any new waterline

71-540	1/2" SWT Tee x 1/4" O.D. Comp	22.76
71-541	3/4" SWT Tee x 1/4" O.D. Comp	23.52
71-542	5/8" O.D. Comp Tee x 1/4" O.D. Comp	29.06
71-543	7/8" O.D. Comp Tee x 1/4" O.D. Comp	35.85
71-545	3/4" SWT Tee x 1/2" MIP NEW	19.78

MALE ADAPTER TUBE X MIP

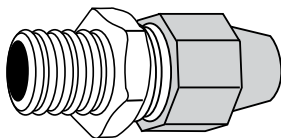

- Ideal for remodeling and repair jobs
- Works with copper, CPVC, Polybutylene and Pex
- Standards/approvals: ASTM, BOCA, CSA, HUD, HUD/FHA, MHI, MSS, NFPA, PHCC, RVI, SBCCI, UL

	PKG QTY	
73-361	1/4" x 3/8" MPT (25)	5.12
73-363	1/2" x 1/2" MPT (25)	5.37
73-364	1/2" x 3/4" MPT (25)	5.90
73-365	3/4" x 3/4" MPT (25)	8.51

POLY ELBOW

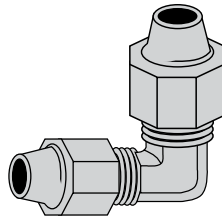

- Ideal for remodeling and repair jobs
- Works with copper, CPVC, Polybutylene and Pex
- Standards/approvals: ASTM, BOCA, CSA, HUD, HUD/FHA, MHI, MSS, NFPA, PHCC, RVI, SBCCI, UL

	PKG QTY	
73-312	1/2" x 1/2" (25)	6.23
73-313	3/4" x 1/2" (25)	8.73
73-314	3/4" x 1/2" (25)	9.56

BRASS FLARE FITTINGS

FLARE CAP



	PKG QTY	
74-475	1/4" (25)	.59¢
74-476	3/8" (25)	.82¢

SHORT FORGED FLARE NUT



	PKG QTY	
74-238	3/8" (25)	1.17
74-239	1/2" (25)	1.34

SHORT ROD FLARE NUT



	PKG QTY	
74-485	1/4" (25)	.71¢
74-486	3/8" (25)	.82¢
74-487	1/2" (25)	1.03
74-488	5/8" (25)	1.72

FLARE MALE ADAPTER SIZE LISTED OD X MIP



	PKG QTY	
74-301	1/4" x 1/4" (25)	.74¢
74-304	3/8" x 3/8" (25)	1.17
74-305	3/8" x 1/2" (25)	1.50
74-309	1/2" x 1/2" (25)	1.66
74-311	5/8" x 1/2" (25)	2.08

FLARE ELBOW OD X MIP

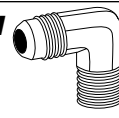

	PKG QTY	
74-151	3/8" (25)	2.19
74-154	1/2" (25)	3.16

POLY/BRASS

POLY COUPLING

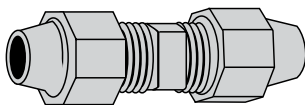

- Ideal for remodeling and repair jobs
- Works with copper, CPVC, Polybutylene and Pex
- Standards/approvals: ASTM, BOCA, CSA, HUD, HUD/FHA, MHI, MSS, NFPA, PHCC, RVI, SBCCI, UL

	PKG QTY	
73-301	3/8" x 3/8" I.D. (25)	4.55
73-302	1/2" x 3/8" I.D. (25)	4.98
73-303	1/2" x 1/2" I.D. (25)	5.19
73-304	3/4" x 1/2" I.D. (25)	6.79
73-305	3/4" x 3/4" I.D. (25)	7.68
73-307	1" x 1" I.D. (25)	9.83

POLY TEE

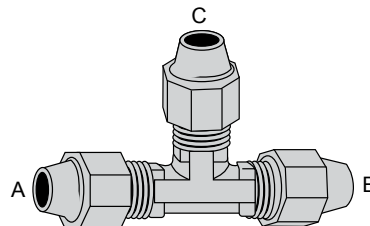

- Ideal for remodeling and repair jobs
- Works with copper, CPVC, Polybutylene and Pex
- Standards/approvals: ASTM, BOCA, CSA, HUD, HUD/FHA, MHI, MSS, NFPA, PHCC, RVI, SBCCI, UL

73-344	1/2" x 1/2" x 1/2" (25)	7.33
73-349	3/4" x 1/2" x 1/4" (25)	8.93
73-346	3/4" x 3/4" x 1/2" (25)	10.54
73-347	3/4" x 3/4" x 3/4" (25)	11.17

**USE YOUR CREDIT CARD AT TIME OF PURCHASE AND SAVE 2% ON ALL ORDERS,
SAVE 5% ON ALL ORDERS OVER \$500 OR SAVE 10% ON ALL ORDERS OVER \$1000**

BRASS COMPRESSION FITTINGS



**VALVES,
FITTINGS, AND
PIPE REPAIR**

COMPRESSION UNION OD x OD

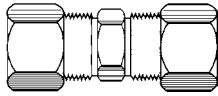

	PKG QTY	
72-401	1/4" x 1/4" (25)	1.10
72-403	3/8" x 3/8" (25)	1.32
72-405	1/2" x 1/2" (25)	2.51
72-408	5/8" x 5/8" (25)	3.04
72-409	7/8" x 7/8" (25)	6.95

COMPRESSION REDUCING UNION OD x OD

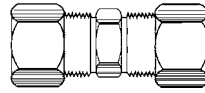

	PKG QTY	
72-402	3/8" x 1/4" (25)	2.28
72-404	1/2" x 3/8" (25)	2.93
72-406	5/8" x 3/8" (25)	4.23
72-407	5/8" x 1/2" (25)	4.60

COMPRESSION X SWEAT ADAPTER OD x NOM

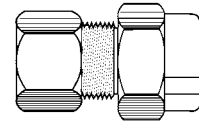

	PKG QTY	
31-118	3/8" OD x 1/2" SWT (25)	1.50

COMPRESSION FEMALE ADAPTER OD x FIP

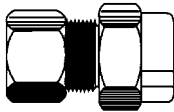

	PKG QTY	
72-353	3/8" x 3/8" (25)	1.61
72-354	3/8" x 1/2" (25)	1.76
72-356	1/2" x 1/2" (25)	2.15
72-357	5/8" x 1/2" (25)	3.28
72-359	7/8" x 3/4" (25)	5.90

COMPRESSION MALE ADAPTER OD x MIP

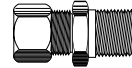

	PKG QTY	
72-300	1/4" x 1/8" (25)	.94¢
72-301	1/4" x 1/4" (25)	1.05
72-602	1/4" x 3/8" (25)	1.91
72-310	1/4" x 1/2" (25)	2.35
72-302	3/8" x 1/4" (25)	1.14
72-619	3/8" x 3/8" (25)	1.91
72-620	3/8" x 1/2" (25)	1.86
72-305	1/2" x 3/8" (25)	1.98
72-622	1/2" x 1/2" (25)	2.04
72-307	5/8" x 1/2" (25)	2.34
72-308	5/8" x 3/4" (25)	3.31
72-309	7/8" x 3/4" (25)	4.59

COMPRESSION TEE OD x OD x OD

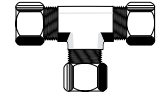

	PKG QTY	
72-200	1/4" (25)	2.66
72-201	3/8" (25)	3.40
72-202	1/2" (25)	5.96
72-203	5/8" (25)	8.02
72-204	7/8" (25)	19.66

REDUCING TEE

72-271	3/8" x 3/8" x 1/4" (25)	4.09
--------	-------------------------	------

COMPRESSION ELBOW OD x OD

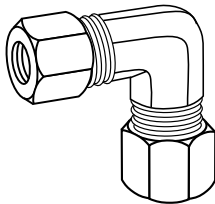

	PKG QTY	
72-177	5/8" x 5/8" (25)	5.32

COMPRESSION REDUCING ELBOW OD x OD

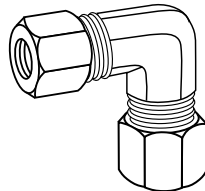

	PKG QTY	
72-281	1/2" x 3/8" (25)	6.52
72-282	5/8" x 3/8" (25)	5.05

COMPRESSION ELBOW OD x MIP

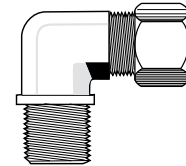

	PKG QTY	
72-151	3/8" x 3/8" (25)	2.19
72-150	3/8" x 3/8" (Forged) (25)	4.71
72-152	3/8" x 1/2" (25)	2.69
72-153	1/2" x 3/8" (25)	3.49

BRASS COMPRESSION SLEEVE OD



SOLD 25 PER PACKAGE ONLY

72-486	For 1/4" tube	.23¢
72-236	1/4" Self Aligning	.35¢
72-237	3/8" Self Aligning	.43¢
72-487	For 3/8" tube	.23¢
72-488	For 1/2" tube	.25¢
72-489	For 5/8" tube	.33¢
72-490	For 7/8" tube	.59¢

DELIN COMPRESSION SLEEVE OD

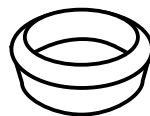

SOLD IN PACKAGE QTY ONLY

	PKG QTY	
72-494	1/4" (100)	.18¢
72-495	3/8" (100)	.18¢
72-496	1/2" (25)	.21¢
72-233	5/8" (25)	.23¢

COMPRESSION ELBOW OD x FIP

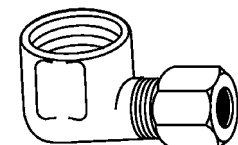

	PKG QTY	
72-102	3/8" x 1/2" (25)	5.12

**USE YOUR CREDIT CARD AT TIME OF PURCHASE AND SAVE 2% ON ALL ORDERS,
SAVE 5% ON ALL ORDERS OVER \$500 OR SAVE 10% ON ALL ORDERS OVER \$1000**

**FAX
1-800-982-5934**

www.HODES CO.com



**PHONE
1-800-777-6500**



BRASS COMPRESSION FITTINGS

COMPRESSION CAP O.D.

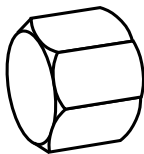

SOLD 25 PER PACKAGE ONLY

72-482	3/8"71¢
72-244	1/2"91¢
72-245	5/8"	1.10

COMPRESSION NUT O.D.

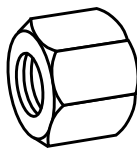

SOLD 25 PER PACKAGE ONLY

72-476	1/4"31¢
72-477	3/8"33¢
72-478	1/2"71¢
72-479	5/8"82¢

CHROME PLATED COMPRESSION NUT O.D.

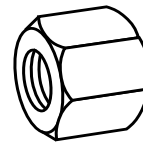

SOLD PER PACKAGE ONLY

			PKG QTY	
31-155	3/8"	(25)	.55¢
31-158	3/8" Polished Brass	NEW	(1)	6.39
31-156	1/2"	NEW	(25)	1.02
31-157	5/8"	(25)	.85¢

BRASS COMPRESSION FERRULE CAP



SOLD 25 PER PACKAGE ONLY

72-321	For 3/8" Tube55¢
--------	---------------	-------	-------------

Case Lot Pricing
available at
www.HodesCo.com

CHROME PLATED BRASS STRAIGHT FEMALE SUPPLY FITTING

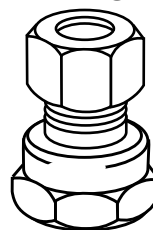

31-100	3/8" OD x 3/8" FIP	2.20
31-101	3/8" OD x 1/2" FIP	2.36

BRASS COMPRESSION

SUPPLY ADAPTER



NEW

31-123	3/8" FL x 3/8" OD Supply Adapter	2.06
--------	----------------------------------	-------	-------------

BARSTOCK CAP



NEW

76-641	Barstock Cap84¢
--------	--------------	-------	-------------



**PAY BY MAJOR CREDIT CARD
WHEN YOU PLACE YOUR ORDER
AND SAVE UP TO AN
ADDITIONAL 10%
OFF OUR ALREADY
INDUSTRY-LOW PRICES!!**

COMPRESSION BRASS INSERT O.D.

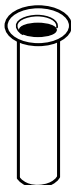

SOLD 25 PER PACKAGE ONLY

72-491	For 1/4" tube23¢
72-492	For 3/8" tube35¢
72-702	For 5/8" tube82¢

CHROME PLATED BRASS STRAIGHT MALE SUPPLY FITTING

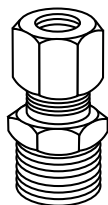

31-120	3/8" OD x 3/8" MIP	2.33
31-121	3/8" OD x 1/2" MIP	2.62

BARSTOCK UNION

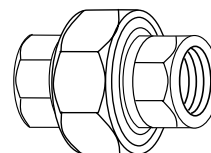

PKG QTY

76-635	1/8"	(25)	15.45
76-636	1/4"	(25)	15.61
76-637	3/8"	(25)	16.42
76-638	1/2"	(25)	21.97

**USE YOUR CREDIT CARD AT TIME OF PURCHASE AND SAVE 2% ON ALL ORDERS,
SAVE 5% ON ALL ORDERS OVER \$500 OR SAVE 10% ON ALL ORDERS OVER \$1000**



BRASS FITTINGS



VALVES, FITTINGS, AND PIPE REPAIR

PLAIN BRASS 90° ELBOW

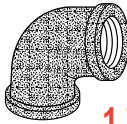

75-100	3/8" IPS	1.78
75-101	1/2" IPS	2.81
75-102	3/4" IPS	3.54
75-103	1" IPS	5.85
75-104	1-1/4" IPS	NEW 13.17
75-105	1-1/2" IPS	NEW 16.48
75-106	2" IPS	NEW 26.77

PLAIN BRASS 90° REDUCING ELBOW

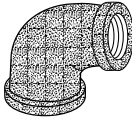

75-109	1/2" x 3/8" IPS	NEW 4.31
75-111	3/4" x 3/8" IPS	NEW 5.90
75-112	3/4" x 1/2" IPS	6.17
75-116	1" x 3/4" IPS	NEW 7.34
75-117	1-1/4" x 1" IPS	NEW 16.10
75-118	1-1/2" x 1-1/4" IPS	NEW 20.36
75-119	2" x 1-1/2" IPS	NEW 37.55

PLAIN BRASS 90° STREET ELBOWS

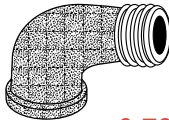

75-120	3/8" IPS	3.78
75-121	1/2" IPS	3.51
75-122	3/4" IPS	NEW 4.96
75-123	1" IPS	NEW 8.22
75-125	1-1/2" IPS	23.06

PLAIN BRASS HEX BUSHING



75-660	1/4" x 1/8" IPS	NEW 1.62
76-664	1/2" MIP x 1/4" FIP	1.30
75-701	1/2" x 3/8" IPS	2.08
75-702	3/4" x 1/2" IPS	2.88
75-705	1" x 1/2" IPS	NEW 4.35
75-703	1" x 3/4" IPS	3.96
75-708	1-1/4" MIP x 1" FIP	NEW 7.06
75-709	1-1/2" MIP x 1/2" FIP	NEW 11.52
75-710	1-1/2" MIP x 3/4" FIP	NEW 11.52
75-711	1-1/2" MIP x 1" FIP	NEW 9.44
75-712	1-1/2" MIP x 1-1/4" FIP	NEW 9.47
75-720	2" MIP x 3/4" FIP	NEW 16.81
75-719	2" MIP x 1" FIP	NEW 16.81
75-718	2" MIP x 1-1/4" FIP	NEW 13.96
75-717	2" MIP x 1-1/2" FIP	NEW 14.02

PLAIN BRASS TEE

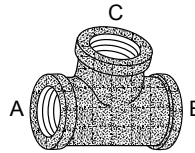

75-200	3/8" IPS	2.75
75-201	1/2" IPS	3.26
75-202	3/4" IPS	4.66
75-203	1" IPS	11.70
75-204	1-1/4" IPS	NEW 16.48
75-205	1-1/2" IPS	NEW 22.66
75-206	2" IPS	NEW 37.08

REDUCING

75-213	3/4" x 1/2" x 1/2" IPS	NEW 7.16
75-218	3/4" x 1/2" x 3/4" IPS	NEW 7.93
75-212	3/4" x 3/4" x 1/2" IPS	7.93
75-207	1" x 1" x 1/2" IPS	NEW 8.76
75-208	1" x 1" x 3/4" IPS	NEW 8.76

PLAIN BRASS COUPLING

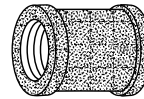

75-400	3/8" IPS	2.64
75-401	1/2" IPS	2.36
75-402	3/4" IPS	3.26
75-403	1" IPS	4.93
75-404	1-1/4" IPS	NEW 10.32
75-405	1-1/2" IPS	NEW 14.02
75-406	2" IPS	NEW 23.06

PLAIN BRASS REDUCER



75-411	1/2" x 3/8" IPS	3.67
75-412	3/4" x 1/2" IPS	3.77
75-407	1" x 1/2" IPS	NEW 8.64
75-413	1" x 3/4" IPS	8.86
75-414	1-1/4" x 1" IPS	9.40
75-417	1-1/2" x 1" IPS	NEW 17.65
75-418	1-1/2" x 1-1/4" IPS	NEW 17.71

PLAIN RED BRASS GROUND JOINT UNIONS

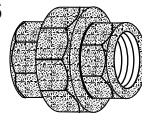

75-301	1/2" IPS	9.54
75-302	3/4" IPS	14.00
75-303	1" IPS	18.62
75-304	1-1/4" IPS	NEW 25.59
75-305	1-1/2" IPS	NEW 32.10

ROUGH BRASS 45° ELBOW



75-131	1/2" IPS	PKG QTY (12) 2.35
75-132	3/4" IPS	PKG QTY (12) 5.50

PLAIN BRASS CROSS

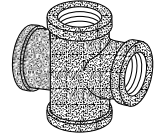

75-223	1/2" IPS	NEW 7.42
75-224	3/4" IPS	NEW 10.72

PLAIN RED BRASS HEAVY PLUGS

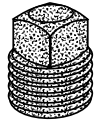

75-600	1/8" IPS	NEW 1.66
75-602	3/8" IPS	2.36
75-603	1/2" IPS	2.36
75-604	3/4" IPS	2.36
75-605	1" IPS	NEW 4.45
75-606	1-1/4" IPS	NEW 5.82

PLAIN RED BRASS CAP



75-500	3/8" IPS	1.82
75-501	1/2" IPS	1.98
75-502	3/4" IPS	2.59
75-503	1" IPS	NEW 5.43

CHROME PLATED BRASS 90° ELBOW



75-150	3/8" IPS	5.88
75-151	1/2" IPS	9.65

CHROMED PLATED BRASS 45° ELBOW



75-180	3/8" IPS	5.76
75-181	1/2" IPS	6.49

CHROMED BRASS COUPLING

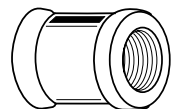

75-450	3/8" IPS	5.89
75-451	1/2" IPS	7.68

USE YOUR CREDIT CARD AT TIME OF PURCHASE AND SAVE 2% ON ALL ORDERS, SAVE 5% ON ALL ORDERS OVER \$500 OR SAVE 10% ON ALL ORDERS OVER \$1000

FAX
1-800-982-5934

www.HODES CO.com
PREFERRED PLUMBING PRODUCTS

PHONE
1-800-777-6500

**VALVES,
FITTINGS, AND
PIPE REPAIR**



PLAIN BRASS & CHROME PLATED NIPPLES

**PLAIN BRASS NIPPLES
1/8" IPS**



75-961	1/8" x Close	1.14
75-962	1/8" x 1-1/2" NEW	1.43
75-963	1/8" x 2"	1.38
75-964	1/8" x 2-1/2"	1.42
75-965	1/8" x 3"	1.57
75-966	1/8" x 3-1/2"	1.99
75-967	1/8" x 4"	2.39
75-968	1/8" x 4-1/2" NEW	2.57
75-969	1/8" x 5"	2.90
75-970	1/8" x 5-1/2" NEW	3.02
75-971	1/8" x 6"	4.27

**PLAIN BRASS NIPPLES
1/4" IPS**



75-950	1/4" x Close	1.50
75-951	1/4" x 1-1/2"	1.61
75-952	1/4" x 2"	1.73
75-953	1/4" x 2-1/2"	1.92
75-955	1/4" x 3-1/2" NEW	2.68
75-956	1/4" x 4"	2.36
75-957	1/4" x 4-1/2"	3.89
75-958	1/4" x 5" NEW	3.73
75-959	1/4" x 5-1/2"	4.50
75-960	1/4" x 6"	4.65

**CHROME PLATED
BRASS NIPPLES
3/8" IPS**



75-800	3/8" x Close	4.34
75-801	3/8" x 1-1/2"	5.23
75-802	3/8" x 2"	6.66
75-803	3/8" x 2-1/2"	6.90
75-804	3/8" x 3"	8.84
75-805	3/8" x 3-1/2"	9.54
75-806	3/8" x 4"	11.34
75-807	3/8" x 4-1/2"	11.52
75-808	3/8" x 5"	13.26
75-809	3/8" x 5-1/2"	14.42
75-810	3/8" x 6"	15.59

**PLAIN BRASS NIPPLES
3/8" IPS**



75-900	3/8" x Close	1.84
75-901	3/8" x 1-1/2"	2.43
75-902	3/8" x 2"	2.77
75-903	3/8" x 2-1/2"	3.06
75-904	3/8" x 3"	3.24
75-905	3/8" x 3-1/2"	3.93
75-906	3/8" x 4"	3.93
75-907	3/8" x 4-1/2"	4.05
75-908	3/8" x 5"	4.38
75-909	3/8" x 5-1/2"	4.89
75-910	3/8" x 6"	5.16

**PLAIN BRASS NIPPLES
1/2" IPS**



75-911	1/2" x Close	1.65
75-912	1/2" x 1-1/2"	2.23
75-913	1/2" x 2"	2.59
75-914	1/2" x 2-1/2"	2.65
75-915	1/2" x 3"	2.81
75-916	1/2" x 3-1/2"	3.17
75-917	1/2" x 4"	3.31
75-918	1/2" x 4-1/2"	3.43
75-919	1/2" x 5"	3.51
75-920	1/2" x 5-1/2"	3.67
75-921	1/2" x 6"	4.46

**CHROME PLATED
BRASS NIPPLES
1/2" IPS**

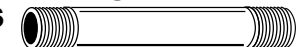

75-811	1/2" x Close	6.19
75-812	1/2" x 1-1/2"	7.15
75-813	1/2" x 2"	8.42
75-814	1/2" x 2-1/2"	10.01
75-815	1/2" x 3"	11.75
75-816	1/2" x 3-1/2"	12.77
75-817	1/2" x 4"	14.65
75-818	1/2" x 4-1/2"	16.68
75-819	1/2" x 5"	17.51
75-820	1/2" x 5-1/2"	18.17
75-821	1/2" x 6"	19.22

**PLAIN BRASS NIPPLES
3/4" IPS**



75-922	3/4" x Close	2.36
75-923	3/4" x 1-1/2"	2.63
75-924	3/4" x 2"	3.04
75-925	3/4" x 2-1/2"	3.36
75-926	3/4" x 3"	4.13
75-927	3/4" x 3-1/2"	4.65
75-928	3/4" x 4"	4.66
75-929	3/4" x 4-1/2"	4.67
75-930	3/4" x 5"	4.68
75-931	3/4" x 5-1/2"	4.69
75-932	3/4" x 6"	5.71

**PLAIN BRASS NIPPLES
1" IPS**



75-933	1" x Close	4.57
75-934	1" x 2"	5.70
75-935	1" x 2-1/2"	6.26
75-936	1" x 3"	7.57
75-937	1" x 3-1/2"	8.76
75-938	1" x 4"	9.95
75-939	1" x 4-1/2"	10.45
75-940	1" x 5"	10.96
75-941	1" x 5-1/2"	13.31
75-942	1" x 6"	13.53

**PLAIN BRASS NIPPLES
1-1/4" IPS**



75-850	1-1/4" x Close	6.96
75-851	1-1/4" x 2"	7.93
75-852	1-1/4" x 2-1/2"	8.97
75-853	1-1/4" x 3"	10.63
75-854	1-1/4" x 3-1/2"	12.40
75-855	1-1/4" x 4"	13.99
75-856	1-1/4" x 4-1/2"	15.47
75-857	1-1/4" x 5"	17.07
75-858	1-1/4" x 5-1/2" NEW	17.62
75-859	1-1/4" x 6"	20.40

**PLAIN BRASS NIPPLES
1-1/2" IPS**



75-860	1-1/2" x Close NEW	9.02
75-861	1-1/2" x 2"	9.70
75-862	1-1/2" x 2-1/2"	11.62
75-863	1-1/2" x 3"	13.38
75-864	1-1/2" x 3-1/2"	15.36
75-865	1-1/2" x 4"	17.42
75-866	1-1/2" x 4-1/2"	19.57
75-867	1-1/2" x 5"	21.66
75-868	1-1/2" x 5-1/2"	23.69
75-869	1-1/2" x 6"	25.72

**PLAIN BRASS NIPPLES
2" IPS**



75-870	2" x Close	14.64
75-871	2" x 2-1/2"	14.84
75-872	2" x 3"	17.14
75-873	2" x 3-1/2"	19.71
75-874	2" x 4"	22.42
75-875	2" x 4-1/2"	24.97
75-876	2" x 5"	27.68
75-877	2" x 5-1/2"	30.38
75-878	2" x 6"	33.09



**PAY BY MAJOR CREDIT CARD
WHEN YOU PLACE YOUR ORDER
AND SAVE UP TO AN
ADDITIONAL 10%
OFF OUR ALREADY
INDUSTRY-LOW PRICES!!**

**USE YOUR CREDIT CARD AT TIME OF PURCHASE AND SAVE 2% ON ALL ORDERS,
SAVE 5% ON ALL ORDERS OVER \$500 OR SAVE 10% ON ALL ORDERS OVER \$1000**

BRASS GARDEN HOSE FITTINGS



**VALVES,
FITTINGS, AND
PIPE REPAIR**

**FEMALE HOSE X
FEMALE PIPE SWIVEL
FGH X FIP**

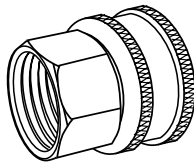

	PKG QTY	
76-123 3/4" x 1/2"	(25)	3.53
76-122 3/4" x 3/4"	(25)	3.89

**FEMALE HOSE X
FEMALE HOSE SWIVEL
FGH X FGH**

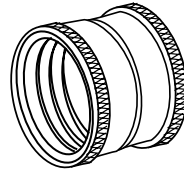

	PKG QTY	
76-124 3/4" x 3/4"	(25)	3.87

**FEMALE HOSE X MALE PIPE
FGH X MIP**

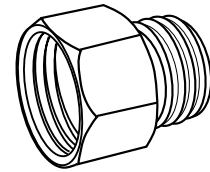

	PKG QTY	
76-105 3/4" x 1/2"	(25)	2.59
76-106 3/4" x 3/4"	(25)	3.26

**GARDEN HOSE SWIVEL
COMPRESSION X FEMALE
"ICE MAKER ADAPTOR"**

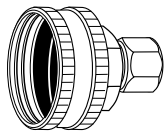

	PKG QTY	
76-116 1/4" x 3/4"	(25)	3.67
76-117 3/8" x 3/4"	(25)	4.16

**HOSE ADAPTER
BARB X MGH**

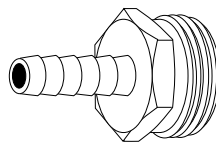

	PKG QTY	
74-757 1/2" x 3/4"	(25)	2.84
74-758 5/8" x 3/4"	(25)	3.15
74-759 3/4" x 3/4"	(25)	2.93

**HOSE SWIVEL
BARB X FGH**

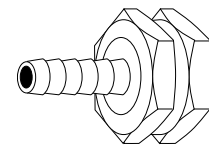

	PKG QTY	
74-753 1/2" x 3/4"	(5)	2.75
74-754 5/8" x 3/4"	(5)	2.84
74-755 3/4" x 3/4"	(5)	2.77

**MALE HOSE X MALE PIPE
MGH X MIP**

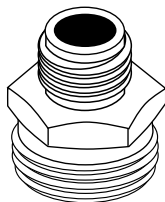

	PKG QTY	
76-100 3/4" x 1/2"	(25)	2.86
76-101 3/4" x 3/4"	(25)	2.62

**MALE HOSE X FEMALE PIPE
MGH X FIP**

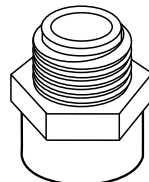

	PKG QTY	
74-763 3/4" x 1/2"	(25)	2.21
76-102 3/4" x 3/4"	(25)	2.73

**MALE HOSE X MALE HOSE
MGH X MGH**

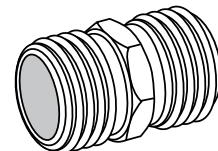

	PKG QTY	
74-765 3/4" x 3/4"	(25)	2.75
74-767 3/4" x 3/4" - Tapped 1/2" FIP ..	(25)	4.58

**HOSE WASHER
NEOPRENE**



SOLD 25 PER PACKAGE ONLY

76-175 Neoprene35¢
76-176 Cloth Inserted35¢
76-177 With Screen82¢

**FEMALE GARDEN HOSE
CAP FGH**

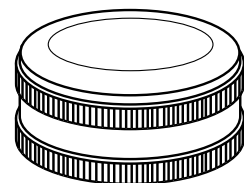

SOLD 5 PER PACKAGE ONLY

76-130 3/4"96¢
-------------------	-------------

GARDEN HOSE



www.HodesCo.com

**USE YOUR CREDIT CARD AT TIME OF PURCHASE AND SAVE 2% ON ALL ORDERS,
SAVE 5% ON ALL ORDERS OVER \$500 OR SAVE 10% ON ALL ORDERS OVER \$1000**

FAX 1-800-982-5934 www.HODESCO.com PHONE 1-800-777-6500



PEX TUBE & FITTINGS

Perfect Pex™

Pex is a state-of-the-art plumbing system that utilizes a new plastic tubing material, cross-linked polyethylene. It can be used for hot and cold potable water and is listed by NSF as safe. It also meets or exceeds the requirements of ASTM F876 and F877.

IMPORTANT

Pex components (insert fittings, crimp rings and tube) **are not interchangeable** with polybutylene or any other insert and crimp components even though they have been designed for use with the same crimp tools and gauges.



Some advantages over other

commonly used plastic plumbing systems:

- Superior temperature tolerance
- Corrosion resistant
- Cost effective installation
- Greater flexibility
- Proven reliability
- Competitive pricing
- Can be used with Qest Qicktite fittings
- Fits Pex cross-linked polyethylene tubing
- Pex fittings are NOT interchangeable with current polybutylene pipe insert fittings and crimp rings
- Fitting contains 3 bars

COUPLING BRASS BARB x BARB



- Fits Pex cross-linked polyethylene tubing
- Pex fittings NOT interchangeable with current polybutylene pipe insert fittings and crimp rings
- Fitting contains 3 bars

Item #	Size	Pkg Qty	Price Ea.
73-201	1/2"	50	.59¢
73-202	3/4" x 1/2"	25	1.18
73-203	3/4"	25	1.18
73-205	1"	15	1.41

FEMALE ADAPTER BRASS BARB x FEMALE SWEAT



- Fits Pex cross-linked polyethylene tubing
- Pex fittings NOT interchangeable with current polybutylene pipe insert fittings and crimp rings
- Fitting contains 3 bars

Item #	Size	Pkg Qty	Price Ea.
73-238	1/2"	50	.66¢
73-239	3/4"	25	1.03
73-269	1"	15	2.53

ELBOW BRASS BARB x BARB



- Fits Pex cross-linked polyethylene tubing
- Pex fittings NOT interchangeable with current polybutylene pipe insert fittings and crimp rings
- Fitting contains 3 bars

Item #	Size	Pkg Qty	Price Ea.
73-231	1/2"	50	1.05
73-233	3/4"	25	1.33
73-234	1"	5	3.49
73-268	3/4" Barb x Fitting	1	5.12

TEE BRASS BARB x BARB x BARB



- Fits Pex cross-linked polyethylene tubing
- Pex fittings NOT interchangeable with current polybutylene pipe insert fittings and crimp rings
- Fitting contains 3 bars

Item #	Size	Pkg Qty	Price Ea.
73-211	1/2"	25	1.50
73-212	1/2" x 1/2" x 3/4"	5	2.04
73-213	3/4" x 1/2" x 1/2"	5	2.04
73-224	3/4" x 1/2" x 3/4"	5	2.04
73-225	3/4"	25	2.04
73-226	3/4" x 3/4" x 1/2"	5	2.04
73-222	3/4" x 3/4" x 1"	5	4.67
73-227	1"	5	3.94
73-223	1" x 3/4" x 3/4"	5	4.06
73-228	1" x 1" x 1/2"	5	3.94
73-229	1" x 1" x 3/4"	5	3.94

DROP EAR ELBOW BRASS BARB x FIP



- Fits Pex cross-linked polyethylene tubing
- Pex fittings NOT interchangeable with current polybutylene pipe insert fittings and crimp rings
- Fitting contains 3 bars

Item #	Size	Pkg Qty	Price Ea.
73-250	1/2"	10	3.94

MALE ADAPTER BRASS BARB x MIP



- Fits Pex cross-linked polyethylene tubing
- Pex fittings NOT interchangeable with current polybutylene pipe insert fittings and crimp rings
- Fitting contains 3 bars

Item #	Size	Pkg Qty	Price Ea.
73-242	1/2"	10	1.39
73-243	1/2" x 3/4"	5	2.61
73-245	3/4"	5	2.13
73-244	3/4" x 1/2"	5	2.23
73-247	1" x 3/4"	5	2.62
73-248	1"	5	2.81

FEMALE ADAPTER BRASS BARB x FIP



- Fits Pex cross-linked polyethylene tubing
- Pex fittings NOT interchangeable with current polybutylene pipe insert fittings and crimp rings
- Fitting contains 3 bars

Item #	Size	Pkg Qty	Price Ea.
73-235	1/2"	10	2.11
73-237	3/4"	5	2.93

FEMALE ADAPTER BRASS SWIVEL BARB x FIP



- Fits Pex cross-linked polyethylene tubing
- Pex fittings NOT interchangeable with current polybutylene pipe insert fittings and crimp rings
- Fitting contains 3 bars

Item #	Size	Pkg Qty	Price Ea.
73-270	1/2"	25	2.20
73-272	3/4"	5	4.03

**USE YOUR CREDIT CARD AT TIME OF PURCHASE AND SAVE 2% ON ALL ORDERS,
SAVE 5% ON ALL ORDERS OVER \$500 OR SAVE 10% ON ALL ORDERS OVER \$1000**

**FAX
1-800-982-5934**

www.HODES CO.com
PROFFERED PLUMBING PRODUCTS

**PHONE
1-800-777-6500**

PEX TUBE & FITTINGS



**VALVES,
FITTINGS, AND
PIPE REPAIR**

Perfect Pex™

Pex is a state-of-the-art plumbing system that utilizes a new plastic tubing material, cross-linked polyethylene. It can be used for hot and cold potable water and is listed by NSF as safe. It also meets or exceeds the requirements of ASTM F876 and F877.

IMPORTANT

Pex components (insert fittings, crimp rings and tube) **are not interchangeable** with polybutylene or any other insert and crimp components even though they have been designed for use with the same crimp tools and gauges.



Some advantages over other

commonly used plastic plumbing systems:

- Superior temperature tolerance
- Corrosion resistant
- Cost effective installation
- Greater flexibility
- Proven reliability
- Competitive pricing
- Can be used with Qest Quicktite fittings
- Fits Pex cross-linked polyethylene tubing
- Pex fittings are NOT interchangeable with current polybutylene pipe insert fittings and crimp rings
- Fitting contains 3 barbs

MALE ADAPTER BRASS BARB x MALE SWEAT

- Fits Pex cross-linked polyethylene tubing
- Pex fittings NOT interchangeable with current polybutylene pipe insert fittings and crimp rings
- Fitting contains 3 barbs



Item #	Size	Pkg Qty	Price Ea.
73-240	1/2"	50	.82¢
73-241	3/4"	25	1.15
73-264	1"	5	2.35

TEST PLUG

- Fits Pex cross-linked polyethylene tubing
- Pex fittings NOT interchangeable with current polybutylene pipe insert fittings and crimp rings
- Fitting contains 3 barbs



Item #	Size	Pkg Qty	Price Ea.
73-260	3/8"	25	.59¢
73-261	1/2"	50	.59¢
73-262	3/4"	25	.94¢
73-263	1"	15	1.18

CRIMP RINGS BLACK COPPER



Item #	Size	Pkg Qty	Price Ea.
73-254	3/8" NEW	100	.26¢
73-255	1/2"	100	.22¢
73-256	3/4"	100	.28¢
73-257	1"	100	.35¢

ADAPTER POLY X PEX



Item #	Size	Pkg Qty	Price Ea.
73-258	1/2"	10	2.54
73-259	3/4"	5	2.83

OETIKER CRIMP STAINLESS STEEL RINGS



NEW

Item #	Size	Pkg Qty	Price Ea.
73-480	3/8"	?	.27¢
73-481	1/2"	?	.33¢
73-482	3/4"	?	.42¢
73-483	1"	?	.54¢

OETIKER CRIMP TOOLS



NEW

Item #	Size	Price Ea.
90-191	1/2-3/4 Composite Crimp Tool	168.83
90-181	3 Handle Ratchet	267.53
90-182	Crimp Tool	93.92

PEX TUBE AVAILABLE AS RED OR BLUE

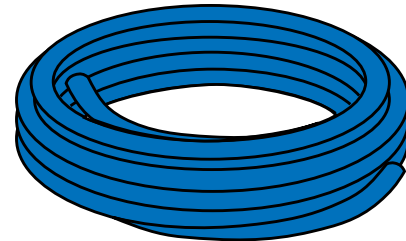

NEW

Item #	Size	Foot Per Package	Price Per Ft.
73-290	3/8" ID x 100 Ft H/C Red Pex Tube	100	.51¢
73-291	3/8" ID x 100 Ft H/C Blue Pex Tube	100	.51¢
73-292	1/2" ID x 100 Ft H/C Red Pex Tube	100	.56¢
73-293	1/2" ID x 100 Ft H/C Blue Pex Tube	100	.56¢
73-294	3/4" ID x 100 Ft H/C Red Pex Tube	100	1.02
73-295	3/4" ID x 100 Ft H/C Blue Pex Tube	100	1.02
73-296	1" ID x 100 Ft H/C Red Pex Tube	100	1.76
73-297	1" ID x 100 Ft H/C Blue Pex Tube	100	1.76

**USE YOUR CREDIT CARD AT TIME OF PURCHASE AND SAVE 2% ON ALL ORDERS,
SAVE 5% ON ALL ORDERS OVER \$500 OR SAVE 10% ON ALL ORDERS OVER \$1000**

FAX 1-800-982-5934 www.HODESCO.com PHONE 1-800-777-6500





BLACK MALLEABLE FITTINGS

**90° BANDED
ELBOW
150 PSI**



BOX QTY.

77-870	1/8"	(50)	.99¢
77-871	1/4"	(35)	.94¢
73-700	3/8"	(45)	.94¢
73-701	1/2"	(50)	.59¢
73-702	3/4"	(35)	.71¢
73-703	1"	(20)	1.20
77-872	1-1/4"	(20)	2.39
77-873	1-1/2"	(10)	3.17
77-874	2"	(8)	5.42

**45° BANDED
ELBOW
150 PSI**



BOX QTY.

77-990	1/8"	(50)	1.41
77-991	1/4"	(30)	1.41
77-992	3/8"	(50)	1.41
77-993	1/2"	(50)	.92¢
77-994	3/4"	(40)	1.12
77-995	1"	(20)	1.42
77-996	1-1/4"	(20)	2.10
73-714	1-1/2"	(20)	3.82
73-715	2"	(12)	4.37

**BANDED
TEE
150 PSI**

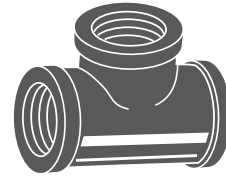

BOX QTY.

73-720	3/8"	(30)	1.41
73-721	1/2"	(40)	.74¢
73-722	3/4"	(35)	1.03
73-723	1"	(20)	1.82
78-112	1-1/4"	(14)	2.88
78-113	1-1/2"	(15)	4.59
78-114	2"	(10)	7.81
78-115	3"	(6)	24.07

**90° BANDED
REDUCING
ELBOW
150 PSI**



BOX QTY.

77-876	1/2" x 1/4"	(40)	1.31
77-877	1/2" x 3/8"	(50)	1.28
77-879	3/4" x 1/2"	(50)	1.07
77-880	1" x 1/2"	(30)	1.44
77-881	1" x 3/4"	(25)	1.44
77-882	1-1/4" x 3/4"	(30)	3.13
77-883	1-1/4" x 1"	(20)	3.88
77-884	1-1/2" x 3/4"	(15)	4.51
77-885	1-1/2" x 1"	(20)	4.51
77-886	1-1/2" x 1-1/4"	(15)	4.51
65-142	2" x 1-1/2"	(20)	5.72

**45° BANDED
STREET
ELBOW
150 PSI**



BOX QTY.

77-999	1/8"	(50)	2.19
78-100	1/4"	(35)	1.63
78-101	3/8"	(50)	1.63
78-102	1/2"	(10)	NEW 1.33
78-103	3/4"	(10)	NEW 2.04
78-104	1"	(10)	NEW 2.37
78-105	1-1/4"	(10)	3.23
78-106	1-1/2"	(10)	3.89
78-107	2"	(12)	6.47

**BANDED
REDUCING
TEE
150 PSI**

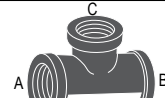

A x B x C.

BOX QTY.

78-134	1/2" x 1/2" x 3/4"	(30)	2.32
78-129	1/2" x 1/2" x 1"	(40)	2.32
78-126	3/4" x 3/4" x 1"	(20)	2.32
73-732	3/4" x 1/2" x 1/2"	(30)	2.13
73-733	3/4" x 1/2" x 3/4"	(40)	2.13
78-117	3/4" x 3/4" x 1/4"	(25)	2.13
73-730	3/4" x 3/4" x 1/2"	(30)	2.13
65-395	1" x 3/4" x 1/2"	(20)	2.36
65-396	1" x 3/4" x 3/4"	(25)	2.13
65-394	1" x 3/4" x 1"	(15)	2.36
65-292	1" x 1/2" x 1/2"	(20)	2.32
73-734	1" x 1/2" x 3/4"	(20)	2.68
78-128	1" x 1/2" x 1"	(15)	2.32
78-118	1" x 1" x 1/2"	(15)	2.13
78-119	1" x 1" x 3/4"	(25)	2.13
65-330	1" x 1" x 1-1/2"	(15)	8.00
65-344	1-1/4" x 1/2" x 1"	(20)	5.12
78-120	1-1/4" x 1/2"	(20)	3.14
78-121	1-1/4" x 3/4"	(12)	4.02
78-122	1-1/4" x 1"	(16)	4.02
78-132	1-1/4" x 1" x 1/2"	(18)	4.61
78-133	1-1/4" x 1" x 3/4"	(18)	4.61
78-127	1-1/4" x 1" x 1"	(18)	4.61
65-721	1-1/2" x 1/2"	(18)	5.09
78-123	1-1/2" x 3/4"	(10)	5.09
65-321	1-1/2" x 1-1/4"	(15)	6.15
78-125	1-1/2" x 1-1/2" x 3/4"	(11)	5.09
65-722	2" x 2" x 1"	(5)	7.95
65-723	2" x 2" x 1-1/4"	(5)	8.42

**90° BANDED
STREET
ELBOW
150 PSI**

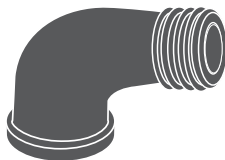

BOX QTY.

77-889	1/8"	(50)	1.41
77-890	1/4"	(35)	1.41
77-891	3/8"	(40)	1.41
77-892	1/2"	(60)	1.17
77-893	3/4"	(35)	1.41
77-894	1"	(30)	1.62
77-895	1-1/4"	(20)	3.11
77-896	1-1/2"	(20)	4.13
77-897	2"	(10)	4.66

**BANDED
CAP
150 PSI**



BOX QTY.

73-735	1/8"	(100)	.93¢
73-736	1/4"	(80)	.78¢
73-737	3/8"	(60)	.78¢
73-738	1/2"	(75)	.61¢
73-739	3/4"	(40)	.76¢
73-740	1"	(35)	.92¢
73-741	1-1/4"	(20)	1.28
73-742	1-1/2"	(18)	1.61
73-743	2"	(12)	2.08

**USE YOUR CREDIT CARD AT TIME OF PURCHASE AND SAVE 2% ON ALL ORDERS,
SAVE 5% ON ALL ORDERS OVER \$500 OR SAVE 10% ON ALL ORDERS OVER \$1000**

BLACK MALLEABLE FITTINGS



VALVES, FITTINGS, AND PIPE REPAIR

BANDED BLACK EXTENSION PIECE

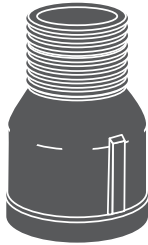

	BOX QTY.	
78-188	1/2" MIP X FIP.. (50)	2.23
78-189	3/4" MIP X FIP.. (40)	2.81
78-193	1-1/4" MIP X FIP (25) NEW	4.30

BANDED COUPLING 150 PSI



	BOX QTY.	
78-160	1/8" (70)	1.38
78-161	1/4" (40)	1.17
78-162	3/8" (50)	1.17
78-163	1/2" (40)	.82¢
78-164	3/4" (50)	1.05
78-165	1" (25)	1.36
73-749	1-1/4" (16)	2.16
78-167	1-1/2" (18)	2.90
78-168	2" (12)	4.21

BANDED REDUCING COUPLING 150 PSI



	BOX QTY.	
78-170	1/4" x 1/8" (50)	1.13
78-173	1/2" x 1/4" (50)	1.03
78-174	1/2" x 3/8" (50) NEW	1.10
78-177	3/4" x 1/2" (60)	.91¢
78-178	1" x 3/8" (30)	2.01
78-179	1" x 1/2" (25)	1.39
78-180	1" x 3/4" (25)	1.39
65-444	1-1/4" x 1/2" (25)	2.49
65-445	1-1/4" x 3/4" (25)	2.98
65-448	1-1/2" x 3/4" (25)	3.57
78-190	1-1/2" x 1" (25)	3.57
65-450	2" x 3/4" (25) NEW	3.94

BUSHING 150 PSI



	BOX QTY.	
78-194	1/4" x 1/8" (100)	1.24
78-195	3/8" x 1/8" (100)	1.24
78-197	1/2" x 1/8" (100)	1.24
73-760	1/2" x 3/8" (100)	1.24
78-200	3/4" x 1/4" (75)	1.21
78-201	3/4" x 3/8" (50)	1.22
73-761	3/4" x 1/2" (50)	1.05
78-202	1" x 1/4" (50)	1.51
78-203	1" x 3/8" (50)	1.56
78-204	1" x 1/2" (50)	1.05
73-762	1" x 3/4" (50)	1.18
65-531	1-1/4" x 1/2" (50)	1.66
65-517	1-1/4" x 3/4" (50)	1.66
73-763	1-1/4" x 1" (50)	1.66
78-219	1-1/2" x 1" (25)	1.67
73-764	1-1/2" x 1-1/4" (25)	1.91
78-210	2" x 3/4" (25)	2.43
65-580	2" x 1-1/4" (25)	2.28
73-765	2" x 1-1/2" (25)	2.54
78-211	2-1/2" x 1-1/4" (25)	4.13
65-535	2-1/2" x 2" (25)	3.81

SQUARE HEAD PLUG 150 PSI

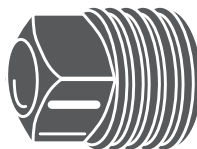

	BOX QTY.	
73-770	1/8" (300)	.61¢
73-771	1/4" (150)	.61¢
73-772	3/8" (100)	.61¢
73-773	1/2" (50)	.52¢
73-774	3/4" (30)	.59¢
73-775	1" (20)	.71¢
73-776	1-1/4" (40)	1.01
73-777	1-1/2" (30)	1.40
78-220	2" (20)	2.00

BRASS TO IRON SEAT UNION 150 PSI



	BOX QTY.	
78-230	1/8" (30)	5.02
78-231	1/4" (20)	5.02
73-780	3/8" (20)	3.23
73-781	1/2" (50)	2.81
73-782	3/4" (35)	2.94
73-783	1" (20)	3.86
73-784	1-1/4" (15)	6.37
73-785	1-1/2" (10)	7.77
73-786	2" (6)	11.76

CROSS



NEW

	BOX QTY.	
78-141	3/8" IPS (50)	2.42
78-142	1/2" IPS (30)	2.76
78-143	3/4" IPS (20)	3.36
78-144	1" IPS (15)	4.15
78-145	1-1/4" IPS (10)	6.72
78-146	1-1/2" IPS (8)	8.32
78-147	2" IPS (5)	13.78

FLOOR FLANGE 150 PSI

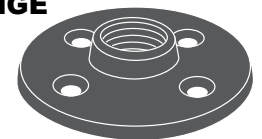

	BOX QTY.	
78-239	3/8" (25)	2.16
78-240	1/2" (25)	2.04
78-241	3/4" (15)	2.19
78-242	1" (15)	2.72
78-243	1-1/4" (10)	3.89
78-244	1-1/2" (8)	4.53
78-245	2" (8)	5.50

BANDED BLACK SERVICE TEE

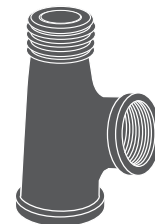

	BOX QTY.	
78-130	1/2" (40)	2.62
78-131	3/4" (25)	3.54

BLACK MALLEABLE

USE YOUR CREDIT CARD AT TIME OF PURCHASE AND SAVE 2% ON ALL ORDERS, SAVE 5% ON ALL ORDERS OVER \$500 OR SAVE 10% ON ALL ORDERS OVER \$1000

FAX 1-800-982-5934 www.HODES CO.com PHONE 1-800-777-6500





BLACK STEEL NIPPLES

BLACK 1/8" STEEL NIPPLES



77-580	Close	NEW	.55¢
77-581	1-1/2"		.55¢
77-582	2"	NEW	.69¢
77-583	2-1/2"	NEW	.74¢
77-584	3"		.59¢
77-585	3-1/2"	NEW	.90¢
77-586	4"	NEW	1.20
77-587	4-1/2"	NEW	1.29
77-588	5"		1.11
77-589	5-1/2"		1.21
77-590	6"	NEW	1.95
77-591	7"		1.42
77-592	8"		1.58

BLACK 1/4" STEEL NIPPLES



77-597	Close	NEW	.46¢
77-598	1-1/2"		.46¢
77-599	2"	NEW	.83¢
77-600	2-1/2"		.71¢
77-601	3"	NEW	.93¢
77-602	3-1/2"		.94¢
57-026	4"		1.05
77-604	4-1/2"	NEW	1.72
77-605	5"		1.05
77-606	5-1/2"		1.18
77-607	6"		1.33
77-622	9"		1.94
77-623	10"		2.16

BLACK 3/8" STEEL NIPPLES



73-580	Close		.66¢
73-581	1-1/2"		.72¢
73-582	2"		.78¢
73-583	2-1/2"		.82¢
73-584	3"	NEW	.56¢
73-585	3-1/2"		.94¢
73-586	4"		1.05
73-587	4-1/2"		1.05
73-588	5"		1.56
73-589	5-1/2"		1.62
73-590	6"		1.77

BLACK 1" STEEL NIPPLES



73-521	Close		.78¢
73-522	2"		.80¢
73-523	2-1/2"		.82¢
73-524	3"		.84¢
73-525	3-1/2"		1.08
73-526	4"		1.11
73-527	4-1/2"		1.17
73-528	5"		1.57
73-529	5-1/2"		1.75
73-530	6"		1.87

BLACK 1/2" STEEL NIPPLES



73-500	Close		.33¢
73-501	1-1/2"		.41¢
73-502	2"		.53¢
73-503	2-1/2"		.55¢
73-504	3"		.61¢
73-505	3-1/2"		.64¢
73-506	4"		.66¢
73-507	4-1/2"		.69¢
73-508	5"		.83¢
73-509	5-1/2"		.91¢
73-510	6"		.94¢
77-620	7"	NEW	1.33
77-621	8"	NEW	1.37
77-610	9"	NEW	1.63
77-611	10"	NEW	1.66
77-624	11"	NEW	1.56
77-625	12"	NEW	1.71

BLACK 3/4" STEEL NIPPLES



73-511	Close		.55¢
77-626	1-1/2"		.59¢
73-512	2"		.61¢
73-513	2-1/2"		.63¢
73-514	3"		.78¢
73-515	3-1/2"		.98¢
73-516	4"		1.00
73-517	4-1/2"		1.02
73-518	5"		1.42
73-519	5-1/2"		1.52
73-520	6"		1.62
77-627	7"	NEW	2.93
77-628	8"	NEW	2.93
77-630	10"	NEW	3.33

BLACK 2" STEEL NIPPLES



73-551	Close		1.50
73-552	2-1/2"		1.62
73-553	3"		1.82
73-554	3-1/2"		1.99
73-555	4"		2.19
73-556	4-1/2"		2.34
73-557	5"		2.68
73-558	5-1/2"		2.95
73-559	6"		3.17

BLACK 1-1/4" STEEL NIPPLE



73-531	Close		.94¢
73-532	2"		1.05
73-533	2-1/2"		1.21
73-534	3"		1.24
73-535	3-1/2"		1.57
73-536	4"		1.63
73-537	4-1/2"		1.71
73-538	5"		1.77
73-539	5-1/2"		1.87
73-540	6"		2.35

BLACK 1-1/2" STEEL NIPPLES



73-541	Close		.94¢
73-542	2"		1.09
73-543	2-1/2"		1.21
73-544	3"		1.33
73-545	3-1/2"		1.37
73-546	4"		1.56
73-547	4-1/2"	NEW	1.72
73-548	5"		1.89
73-549	5-1/2"		1.95
73-550	6"		2.11
73-595	10 pc. Bulk Close Thru 6"		23.48

66 PIECE BLACK STEEL NIPPLE ASSORTMENT

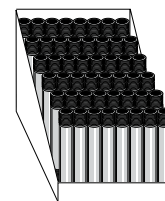

• Includes 6 each of close, 1-1/2", 2", 2-1/2", 3", 3-1/2", 4", 4-1/2", 5", 5-1/2" & 6" lengths
 • Packaged in durable cardboard box with handle

73-567	1/2" Assortment		43.89
73-568	3/4" Assortment		49.90
73-569	1" Assortment	NEW	67.16

USE YOUR CREDIT CARD AT TIME OF PURCHASE AND SAVE 2% ON ALL ORDERS, SAVE 5% ON ALL ORDERS OVER \$500 OR SAVE 10% ON ALL ORDERS OVER \$1000

GALVANIZED MALLEABLE FITTINGS



VALVES, FITTINGS, AND PIPE REPAIR

90° BANDED ELBOW 150 PSI

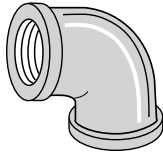

Part No.	Size	BOX QTY.	Price
77-660	1/8"	(50)	1.27
77-661	1/4"	(35)	.89¢
73-800	3/8"	(45)	1.27
73-801	1/2"	(50)	.71¢
73-802	3/4"	(35)	.85¢
73-803	1"	(20)	1.52
73-804	1-1/4"	(20)	2.93
73-805	1-1/2"	(10)	3.87
73-806	2"	(8)	5.13

PLUG 150 PSI

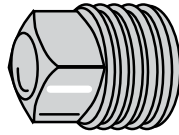

Part No.	Size	BOX QTY.	Price
73-871	1/4"	(150)	NEW .65¢
73-872	3/8"	(100)	.65¢
73-873	1/2"	(50)	.94¢
73-874	3/4"	(30)	1.18
73-875	1"	(20)	1.33
73-876	1-1/4"	(40)	2.06
73-877	1-1/2"	(30)	2.80
73-878	2"	(20)	3.03

BANDED TEE 150 PSI

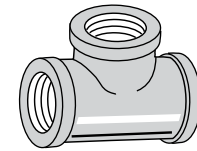

Part No.	Size	BOX QTY.	Price
77-710	1/8"	(80)	1.91
73-820	3/8"	(30)	1.91
73-821	1/2"	(40)	1.39
73-822	3/4"	(35)	1.50
73-823	1"	(20)	3.12
77-712	1-1/4"	(14)	3.89
73-825	1-1/2"	(15)	5.54
77-714	2"	(10)	6.17

90° BANDED REDUCING ELBOW 150 PSI

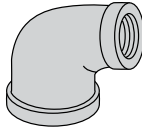

Part No.	Size	BOX QTY.	Price
77-665	3/8" x 1/4"	(60)	1.31
77-666	1/2" x 1/4"	(40)	1.49
77-667	1/2" x 3/8"	(50)	1.49
77-668	3/4" x 3/8"	(25)	1.72
77-669	3/4" x 1/2"	(30)	1.72
77-670	1" x 1/2"	(30)	2.61
77-671	1" x 3/4"	(25)	2.61
77-672	1-1/4" x 3/4"	(15)	4.40
77-673	1-1/4" x 1"	(10)	4.40
77-674	1-1/2" x 3/4"	(15)	5.65
77-675	1-1/2" x 1"	(10)	5.65
77-676	1-1/2" x 1-1/4"	(15)	5.65

BANDED CAP 150 PSI

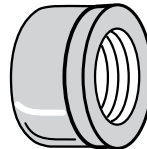

Part No.	Size	BOX QTY.	Price
73-835	1/8"	(120)	NEW 1.18
73-836	1/4"	(80)	1.18
73-837	3/8"	(60)	1.18
73-838	1/2"	(50)	1.00
73-839	3/4"	(40)	1.15
73-840	1"	(25)	1.33
77-750	1-1/4"	(20)	1.36
77-751	1-1/2"	(18)	1.91
77-752	2"	(12)	2.18

BANDED REDUCING TEE 150 PSI

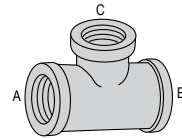

Part No.	Size A x B x C	BOX QTY.	Price
73-831	1/2" x 1/2" x 3/4"	(40)	NEW 1.92
73-830	3/4" x 1/2"	(30)	1.90
73-832	3/4" x 1/2" x 1/2"	(30)	2.17
73-833	3/4" x 1/2" x 3/4"	(40)	2.17
77-721	1" x 3/4"	(25)	2.78
77-736	1" x 3/4" x 1/2"	(20)	3.24
77-737	1" x 3/4" x 3/4"	(25)	2.68
77-724	1-1/4" x 1"	(16)	3.43
77-753	1-1/2" x 1/2"	(18)	6.73
64-318	1-1/2" x 1"	(13)	6.37
77-727	1-1/2" x 1-1/4"	(15)	6.58
77-732	2" x 2" x 1-1/2"	(8)	7.23

90° BANDED STREET ELBOW 150 PSI

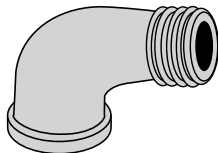

Part No.	Size	BOX QTY.	Price
77-677	1/8"	(60)	1.72
77-678	1/4"	(35)	1.72
77-679	3/8"	(40)	1.72
73-815	1/2"	(60)	1.65
73-816	3/4"	(35)	1.95
77-682	1"	(30)	2.34
77-683	1-1/4"	(25)	2.83
77-684	1-1/2"	(9)	3.73
77-685	2"	(10)	5.84

BRASS TO IRON SEAT UNION 150 PSI

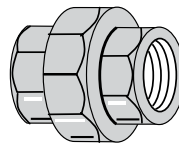

Part No.	Size	BOX QTY.	Price
73-879	1/8"	(30)	5.93
73-880	3/8"	(20)	3.81
73-881	1/2"	(50)	3.42
73-882	3/4"	(35)	3.81
73-883	1"	(20)	4.70
73-884	1-1/4"	(15)	7.73
73-885	1-1/2"	(10)	6.62
73-886	2"	(6)	8.83

BANDED COUPLING 150 PSI

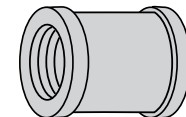

Part No.	Size	BOX QTY.	Price
77-762	3/8"	(40)	NEW 1.05
77-763	1/2"	(40)	1.03
77-764	3/4"	(50)	1.18
77-765	1"	(25)	1.67
73-849	1-1/4"	(16)	3.12
73-850	1-1/2"	(18)	2.37
77-768	2"	(12)	3.46

USE YOUR CREDIT CARD AT TIME OF PURCHASE AND SAVE 2% ON ALL ORDERS, SAVE 5% ON ALL ORDERS OVER \$500 OR SAVE 10% ON ALL ORDERS OVER \$1000

FAX 1-800-982-5934 www.HODES CO.com PHONE 1-800-777-6500





GALVANIZED MALLEABLE FITTINGS

**45° BANDED
ELBOW
150 PSI**



	BOX QTY.	
77-686	1/8" (50)	1.92
77-687	1/4" (30)	1.72
77-688	3/8" (50)	1.72
77-689	1/2" (50)	1.05
73-811	3/4" (40)	1.47
77-691	1" (20)	1.86
77-692	1-1/4" (20)	3.83
77-693	1-1/2" (10)	4.69
77-694	2" (12)	5.09

**BUSHING
150 PSI**

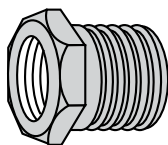

	BOX QTY.	
73-859	1/2" x 1/4" (100)	NEW 1.79
73-860	1/2" x 3/8" (100)	1.79
77-805	3/4" x 1/8" (50)	1.79
73-861	3/4" x 1/2" (50)	1.46
77-809	1" x 3/8" (50)	3.43
73-862	1" x 3/4" (50)	1.85
73-863	1-1/4" x 1" (30)	3.39
77-813	1-1/2" x 1/2" (25)	3.63
73-864	1-1/2" x 1-1/4" (25)	4.27
77-816	2" x 1/2" (20)	4.54
77-822	2-1/2" x 2" (15)	5.78

**GALVANIZED
EXTENSION PIECE**

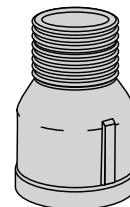

	BOX QTY.	
64-621	1/2" MIP x FIP (50)	3.38
64-622	3/4" MIP x FIP (40)	NEW 4.84

**BANDED
REDUCING
COUPLING**

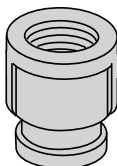

	BOX QTY.	
77-773	1/2" x 3/8" (40)	.98¢
77-776	3/4" x 1/2" (60)	1.18
77-774	1" x 3/8" (40)	NEW 2.01
77-777	1" x 1/2" (30)	1.55
77-778	1" x 3/4" (25)	1.75
77-781	1-1/4" x 1" (15)	1.97
77-785	1-1/2" x 1-1/4" (12)	2.39
77-788	2" x 1" (14)	5.17
77-790	2" x 1-1/2" (12)	5.26

**45° STREET
ELBOW**

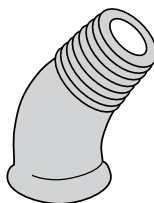

	BOX QTY.	
77-698	1/2" (75)	1.53
77-699	3/4" (40)	2.05
77-700	1" (25)	2.53

**GALVANIZED
CROSS**

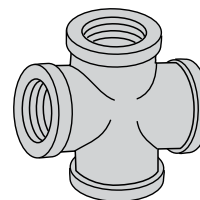

	BOX QTY.	
77-741	3/8" (50)	NEW 3.54
77-742	1/2" (30)	2.84
77-743	3/4" (20)	3.46
77-744	1" (15)	4.77
77-745	1-1/4" (10)	NEW 8.63
77-746	1-1/2" (8)	NEW 10.47
77-747	2" (5)	NEW 19.96

**GALVANIZED
FLOOR FLANGE**

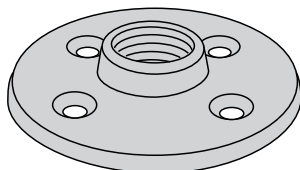

	BOX QTY.	
77-850	1/2" (25)	3.59
77-851	3/4" (15)	4.00
77-852	1" (15)	4.40
77-853	1-1/4" (10)	5.01
77-854	1-1/2" (8)	6.26
77-855	2" (8)	8.24

HODES CO
PROFERRED PLUMBING PRODUCTS

Case Lot Pricing
available at
www.HodesCo.com

**USE YOUR CREDIT CARD AT TIME OF PURCHASE AND SAVE 2% ON ALL ORDERS,
SAVE 5% ON ALL ORDERS OVER \$500 OR SAVE 10% ON ALL ORDERS OVER \$1000**

GALVANIZED STEEL NIPPLES



**VALVES,
FITTINGS, AND
PIPE REPAIR**

GALVANIZED 1/8" STEEL NIPPLES



Item	Close	BOX QTY	Price
56-001	Close	(25)	.53¢
77-501	1-1/2"	(25)	.69¢
77-502	2"	(25)	.76¢
77-503	2-1/2"	(25)	.76¢
77-504	3"	(25)	1.33
77-505	3-1/2"	(25)	1.47
77-506	4"	(25)	1.57
77-507	4-1/2"	(25)	1.78
77-508	5"	(25)	1.86
77-509	5-1/2"	(25)	1.78
77-510	6"	(25)	1.75

GALVANIZED STEEL NIPPLES 1/4" IPS



Item	Close	BOX QTY	Price
56-020	Close	(25)	.66¢
56-021	1-1/2"	(25)	.72¢
56-022	2"	(25)	.79¢
77-520	2-1/2"	(25)	.71¢
77-521	3"	(25)	.98¢
77-522	3-1/2"	(25)	1.11
77-523	4"	(25)	1.18
77-524	4-1/2"	(25)	1.34
77-525	5"	(25)	1.57
77-526	5-1/2"	(25)	1.87
77-527	6"	(25)	2.01

GALVANIZED 2" STEEL NIPPLES



Item	Close	BOX QTY	Price
73-651	Close	(25)	2.68
73-652	2-1/2"	(25)	2.96
73-653	3"	(25)	3.38
73-654	3-1/2"	(25)	1.89
73-655	4"	(25)	2.54
73-656	4-1/2"	(25)	4.60
73-657	5"	(25)	4.85
73-658	5-1/2"	(25)	2.73
73-659	6"	(25)	4.83
77-574	10"	(25)	8.13

GALVANIZED STEEL NIPPLES 3/8" IPS



Item	Close	BOX QTY	Price
73-680	Close	(25)	.75¢
73-681	1-1/2"	(25)	.78¢
73-682	2"	(25)	.86¢
73-683	2-1/2"	(25)	.92¢
73-684	3"	(25)	1.00
73-685	3-1/2"	(25)	1.10
73-686	4"	(25)	1.33
73-687	4-1/2"	(25)	1.66
73-688	5"	(25)	1.82
73-689	5-1/2"	(25)	2.11
73-690	6"	(25)	2.35

GALVANIZED STEEL NIPPLES 1/2" IPS



Item	Close	BOX QTY	Price
73-600	Close	(25)	.55¢
73-601	1-1/2"	(25)	.61¢
73-602	2"	(25)	.71¢
73-603	2-1/2"	(25)	.83¢
73-604	3"	(25)	.89¢
73-605	3-1/2"	(25)	.99¢
73-606	4"	(25)	1.05
73-607	4-1/2"	(25)	1.09
73-608	5"	(25)	1.17
73-609	5-1/2"	(25)	1.24
73-610	6"	(25)	1.31

GALVANIZED STEEL NIPPLES 3/4" IPS



Item	Close	BOX QTY	Price
73-611	Close	(25)	.61¢
73-699	1-1/2"	(25)	.51¢
73-612	2"	(25)	.78¢
73-613	2-1/2"	(25)	.82¢
73-614	3"	(25)	.86¢
73-615	3-1/2"	(25)	.94¢
73-616	4"	(25)	1.04
73-617	4-1/2"	(25)	1.09
73-618	5"	(25)	1.15
73-619	5-1/2"	(25)	1.21
73-620	6"	(25)	1.31

GALVANIZED 1" STEEL NIPPLES



Item	Close	BOX QTY	Price
73-621	Close	(25)	1.01
73-622	2"	(25)	1.10
73-623	2-1/2"	(25)	1.18
56-105	3"	(25)	1.40
73-625	3-1/2"	(25)	1.61
73-626	4"	(25)	1.76
73-627	4-1/2"	(25)	1.90
73-628	5"	(25)	2.01
73-629	5-1/2"	(25)	2.09
73-630	6"	(25)	2.36

GALVANIZED 1-1/4" STEEL NIPPLES



Item	Close	BOX QTY	Price
73-631	Close	(25)	1.18
73-632	2"	(25)	1.26
73-633	2-1/2"	(25)	1.33
73-634	3"	(25)	1.73
73-635	3-1/2"	(25)	1.99
73-636	4"	(25)	2.15
73-637	4-1/2"	(25)	2.33
73-638	5"	(25)	2.56
73-639	5-1/2"	(25)	2.88
73-640	6"	(25)	3.14
77-561	10"	(25)	4.70

GALVANIZED 1-1/2" STEEL NIPPLES



Item	Close	BOX QTY	Price
73-641	Close	(25)	1.50
73-642	2"	(25)	1.77
73-643	2-1/2"	(25)	1.87
73-644	3"	(25)	1.99
73-645	3-1/2"	(25)	2.36
73-646	4"	(25)	2.75
73-647	4-1/2"	(25)	3.16
73-648	5"	(25)	3.33
73-649	5-1/2"	(25)	3.72
73-650	6"	(25)	3.98

66 PIECE GALVANIZED STEEL NIPPLE ASSORTMENT

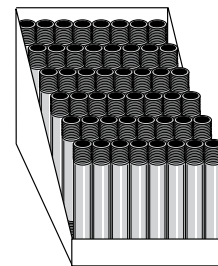

• Includes 6 each of close, 1-1/2", 2", 2-1/2", 3", 3-1/2", 4", 4-1/2", 5", 5-1/2" & 6" lengths
• Packaged in durable cardboard box with handle

73-667	1/2" Assortment	47.20
73-668	3/4" Assortment	59.03

HONOR THY PLUMBER™

**USE YOUR CREDIT CARD AT TIME OF PURCHASE AND SAVE 2% ON ALL ORDERS,
SAVE 5% ON ALL ORDERS OVER \$500 OR SAVE 10% ON ALL ORDERS OVER \$1000**

**FAX
1-800-982-5934**

www.HODES CO.com
PREFERRED PLUMBING PRODUCTS

**PHONE
1-800-777-6500**



PVC SCHEDULE 40 FITTINGS

Perfect Fit™ SCHEDULE 40 PVC SLIP TEE

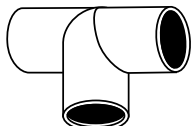

Part No.	Size	Box Qty	Price
72-710	1/2"	(10)	.34¢
72-733	1/2" x 1/2" x 1/2" FIP	(10) NEW	.71¢
72-711	3/4"	(10)	.43¢
72-509	1"	(10)	.73¢
72-575	1-1/4"	(10)	1.61
72-718	2"	(10)	2.00
72-572	3/4" x 3/4" x 1/2"	(10)	1.62
72-581	1" x 1" x 1/2"	(10)	1.66
72-715	1" x 1" x 3/4"	(10)	1.70

Perfect Fit™ SCHEDULE 40 PVC 90° SLIP ELBOW

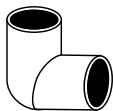

Part No.	Size	Box Qty	Price
72-720	1/2"	(10)	.28¢
72-560	1/2" 90° PVC Elb MIP X FIP	(10)	.88¢
72-561	1/2" Street Elbow	(10)	1.17
72-556	1/2" SLIP x 1/2" FIP	(10)	.46¢
72-721	3/4"	(10)	.31¢
72-564	3/4" Street Elbow	(10) NEW	1.22
72-565	3/4" Slip x MIP	(10) NEW	1.13
72-722	1"	(10)	.55¢
72-616	1" Street	(10) NEW	2.53
72-554	1-1/4"	(10)	1.19
72-724	1-1/2"	(10)	1.31
72-725	2"	(10)	2.33
72-726	2-1/2"	(1)	5.30
72-727	3"	(1)	8.45

Perfect Fit™ SCHEDULE 40 PVC MALE ADAPTER SLIP X MALE

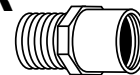

Part No.	Size	Box Qty	Price
72-750	1/2"	(10)	.25¢
72-751	3/4"	(10)	.28¢
72-752	1"	(10)	.48¢
72-753	1-1/4"	(10)	.69¢
72-754	1-1/2"	(10)	1.17
72-793	2"	(10)	1.32

Perfect Fit™ SCHEDULE 40 PVC CROSS

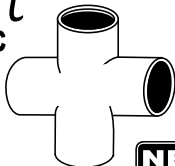

Part No.	Size	Box Qty	Price
72-526	1/2"	(10)	2.05
72-527	3/4"	(10)	3.20
72-528	1"	(10)	3.49

Perfect Fit™ SCHEDULE 40 PVC BUSHING SPG X FIP

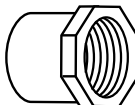

Part No.	Size	Box Qty	Price
72-571	3/4" x 1/2"	(10)	.67¢
72-599	1" x 1/2"	(10)	1.09
72-601	1" x 3/4"	(10)	1.09
72-784	1-1/4" x 1/2"	(10)	1.17
72-785	1-1/4" x 3/4"	(10)	1.17
72-786	1-1/4" x 1"	(10)	1.17
72-789	2" x 3/4"	(10)	1.81
72-790	2" x 1"	(10)	1.85
72-791	2" x 1-1/4"	(10)	2.07
72-792	2" x 1-1/2"	(10)	2.09

Perfect Fit™ SCHEDULE 40 PVC FEMALE ADAPTER SLIP X FEMALE

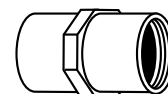

Part No.	Size	Box Qty	Price
72-744	1/2"	(10)	.31¢
72-745	3/4"	(10)	.38¢
72-746	1"	(10)	.45¢
72-747	1-1/4"	(10)	.65¢
72-748	1-1/2"	(10)	1.17
72-795	2"	(10)	1.32

Perfect Fit™ SCHEDULE 40 PVC COUPLING SLIP X SLIP

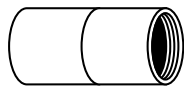

Part No.	Size	Box Qty	Price
72-736	1/2"	(10)	.18¢
72-737	3/4"	(10)	.30¢
72-738	1"	(10)	.42¢
72-085	1-1/4"	(10)	.84¢
72-740	1-1/2"	(10)	.69¢
72-741	2"	(10)	1.41
72-743	3"	(10)	4.23

Perfect Fit™ SCHEDULE 40 PVC SLIP BUSHING SPG X SLIP

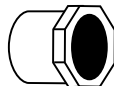

Part No.	Size	Box Qty	Price
72-765	3/4" x 1/2"	(10)	.34¢
72-766	1" x 1/2"	(10)	.71¢
72-598	1" x 3/4"	(10)	.59¢
72-530	1-1/4" x 1"	(10)	.71¢
72-768	1-1/4" x 1/2"	(10)	.71¢
72-769	1-1/4" x 3/4"	(10)	.71¢
72-771	1-1/2" x 3/4"	(10)	.95¢
72-774	2" x 1/2"	(10)	1.44
72-775	2" x 3/4"	(10)	1.44
72-779	2-1/2" x 2"	(10)	2.20
72-780	3" x 2-1/2"	(10)	2.90

Perfect Fit™ SCHEDULE 40 PVC SLIP CAP

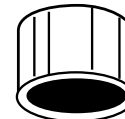

Part No.	Size	Box Qty	Price
72-513	1/2"	(10)	.25¢
72-541	3/4"	(10)	.28¢
72-758	1"	(10)	.45¢
72-760	1-1/2"	(10)	.71¢
72-761	2"	(10)	1.23
72-762	3"	(10)	3.02

Perfect Fit™ SCHEDULE 40 PVC 45° SLIP ELBOW

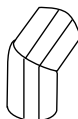

Part No.	Size	Box Qty	Price
72-728	1/2"	(10)	.45¢
72-729	3/4"	(10)	.69¢
72-730	1"	(10)	.82¢
72-731	1-1/4"	(10)	1.18
72-512	1-1/2"	(10)	1.79
72-794	2"	(10)	2.34
72-734	2-1/2"	(1)	5.14
72-735	3"	(1)	7.96

Perfect Fit™ SCHEDULE 40 PVC THREADED CAP

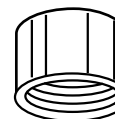

Part No.	Size	Box Qty	Price
72-763	1/2"	(10)	.69¢
72-562	1-1/2"	(10)	1.17
72-563	2"	(10)	2.26

**USE YOUR CREDIT CARD AT TIME OF PURCHASE AND SAVE 2% ON ALL ORDERS,
SAVE 5% ON ALL ORDERS OVER \$500 OR SAVE 10% ON ALL ORDERS OVER \$1000**



CPVC FITTINGS



VALVES, FITTINGS, AND PIPE REPAIR

CPVC COUPLING

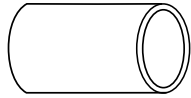

72-845	1/2"	BOX QTY. (20)	.42¢
72-531	3/4"	(20)	.57¢
72-838	3/4" x 1/2"	(20)	.52¢
72-846	1"	(10)	1.51

CPVC 45° ELBOW

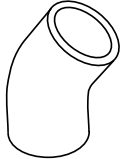

72-543	1/2"	BOX QTY. (20)	.55¢
72-544	3/4"	(20)	.86¢
72-545	1"	(10)	1.76

CPVC 90° STREET ELBOW

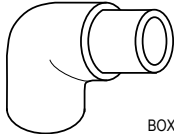

72-549	1/2"	BOX QTY. (10)	.55¢
72-550	3/4"	(10)	1.44

CPVC 45° STREET ELBOW



72-551	1/2"	BOX QTY. (20)	.71¢
72-552	3/4"	(20)	1.05

CPVC BUSHING

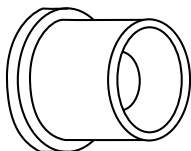

72-566	3/4" x 1/2"	BOX QTY. (10)	.55¢
72-568	1" x 3/4"	(10)	1.22

CPVC 90° ELBOW

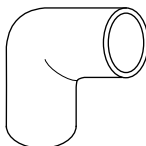

72-537	1/2"	BOX QTY. (20)	.35¢
72-840	3/4"	(20)	.59¢
72-539	1"	(10)	2.11

CPVC CAP

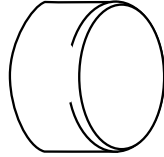

72-850	1/2"	BOX QTY. (10)	.59¢
72-576	3/4"	(10)	.99¢
72-577	1"	(10)	1.05

CPVC TEE

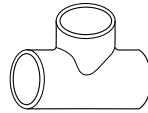

72-553	1/2"	BOX QTY. (20)	.46¢
79-555	3/4"	(20)	.98¢
72-841	3/4" x 1/2" x 1/2"	(20)	1.10
72-842	3/4" x 3/4" x 1/2"	(20)	1.10
72-843	3/4" x 1/2" x 3/4"	(20)	1.15
72-555	1"	(10)	4.12

CPVC MALE ADAPTER

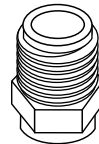

72-849	1/2"	BOX QTY. (20)	.46¢
72-582	3/4"	(20)	.65¢
72-583	1"	(10)	2.84

CPVC FEMALE ADAPTER

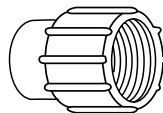

72-587	1/2"	BOX QTY. (20)	1.53
72-588	3/4"	(10)	4.05
72-589	1"	(10)	2.69

CPVC X FIP 90° ELBOW



72-590		BOX QTY.	
72-851	1/2" CPVC x 1/2" FIP	(10)	7.62
72-590	1/2" CPVC x 1/2" FIP	(10)	2.13

CPVC / BRASS METAL HEX TRANSITION ADAPTER

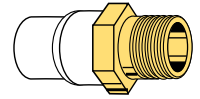

- Injection molded
- Male thread x CPVC socket
- One-piece construction

72-592	1/2"	BOX QTY. (10)	4.42
72-593	3/4"	(10)	4.66
72-603	1"	(10)	5.61

CPVC / BRASS METAL HEX TRANSITION ADAPTER

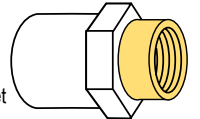

- Injection molded
- Female thread x CPVC socket
- One-piece construction

72-844	1/2"	BOX QTY. (10)	4.42
72-596	3/4"	(10)	4.66
72-607	1"	(10)	4.94

CPVC TRANSITION FITTING FIP OR MIP

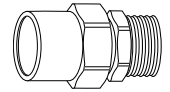

- CPVC Pre-Torqued Fittings
- CPVC Solvent Weld x FIP or MIP Unions
- Eliminates the Need for Tightening on the Job

72-800	1/2" FIP	7.05
72-801	3/4" FIP	10.18
72-803	1/2" MIP (shown)	7.05
72-804	3/4" MIP (shown)	10.18

CPVC X OD TRANSITION FITTING



72-805	3/4" CPVC x 7/8" OD	BOX QTY. (10)	16.09
--------	---------------------	---------------	--------------

CPVC X FIP TRANSITION UNION



72-806	3/4" CPVC x 3/4" FIP	BOX QTY. (10)	7.24
--------	----------------------	---------------	-------------

USE YOUR CREDIT CARD AT TIME OF PURCHASE AND SAVE 2% ON ALL ORDERS, SAVE 5% ON ALL ORDERS OVER \$500 OR SAVE 10% ON ALL ORDERS OVER \$1000

FAX 1-800-982-5934

www.HODES CO.com

PHONE 1-800-777-6500



PVC DWV SCHEDULE 40

**1/4 BEND PVC DWV
SCHEDULE 40
90° ELBOW
HUB X HUB**



CASE QTY

72-860	1-1/2" Hub x Hub	(100)	1.17
72-861	2" Hub x Hub	(50)	1.72
72-862	3" Hub x Hub	(25)	5.33
72-837	4" Hub x Hub	(10)	9.73

**1/4 BEND PVC DWV
SCHEDULE 40
90° STREET
ELBOW
HUB X SPG**



CASE QTY

72-852	1-1/2" Hub x SPG	(100)	1.43
72-853	2" Hub x SPG	(50)	2.21
72-854	3" Hub x SPG	(20)	5.47
72-855	4" Hub x SPG	(10)	10.76

**PVC DWV SCHEDULE 40
90° LONG
SWEEP ELBOW
HUB X HUB**



CASE QTY

72-856	1-1/2" Hub x Hub	(50)	2.68
72-857	2" Hub x Hub	(25)	2.90
72-858	3" Hub x Hub	(10)	6.63
72-859	4" Hub x Hub	(5)	12.64

**PVC DWV SCHEDULE 40
90° VENT ELLS
HUB X HUB**



CASE QTY

72-871	1-1/2" Hub x Hub	(100)	2.23
72-872	2" Hub x Hub	(50)	3.12
72-873	3" Hub x Hub	(25)	7.84

**1/6 BEND PVC DWV
SCHEDULE 40
60° ELBOW
HUB X HUB**



CASE QTY

72-888	1-1/2" Hub x Hub	(50)	2.10
72-889	2" Hub x Hub	(20)	2.80
72-890	3" Hub x Hub	(10)	9.92
72-891	4" Hub x Hub	(5)	14.09

**1/16 STREET BEND
PVC DWV SCHEDULE 40
22-1/2° ELBOW
SPG X HUB**



CASE QTY

72-896	1-1/2" SPG x Hub	(50)	4.34
72-897	2" SPG x Hub	(50)	4.63
72-898	3" SPG x Hub	(20)	7.29
72-899	4" SPG x Hub	(10)	10.63

**1/8 BEND PVC DWV
SCHEDULE 40
45° ELBOW
HUB X HUB**



CASE QTY

72-870	1-1/2" Hub x Hub	(100)	1.07
72-824	2" Hub x Hub	(50)	1.65
72-825	3" Hub x Hub	(20)	4.51
72-826	4" Hub x Hub	(10)	7.75

**1/16 BEND PVC DWV
SCHEDULE 40
22-1/2° ELBOW
HUB X HUB**



CASE QTY

72-892	1-1/2" Hub x Hub	(50)	1.53
72-893	2" Hub x Hub	(50)	1.90
72-894	3" Hub x Hub	(20)	4.87
72-895	4" Hub x Hub	(10)	7.43

**1/8 BEND PVC DWV
SCHEDULE 40
45° STREET
SPG X HUB**



CASE QTY

72-827	1-1/2"	(20)	1.10
72-828	2"	(20)	1.66
72-829	3"	(5)	4.34

**PVC DWV SCHEDULE 40
DOUBLE ELLS
HUB X HUB X HUB**



CASE QTY

72-900	1-1/2" Hub x Hub x Hub	(50)	3.81
72-901	2" Hub x Hub x Hub	(25)	5.34
72-904	2" x 1-1/2" x 1-1/2" Red	(25)	5.09
72-902	3" Hub x Hub x Hub	(10)	16.32
72-903	4" Hub x Hub x Hub	(5)	24.99

**PVC DWV SCHEDULE 40
90° ELLS WITH
LOW HEEL INLET
HUB X HUB X HUB**



CASE QTY

72-905	3" x 3" x 1-1/2"	(20)	8.54
72-906	3" x 3" x 3"	(20)	10.31
72-907	4" x 4" x 2"	(15)	20.35

**PVC DWV SCHEDULE 40
REDUCING
CLOSET BEND
HUB X HUB**



CASE QTY

72-908	4" x 3" Hub x Hub	(10)	8.35
--------	-------------------	------	------

**USE YOUR CREDIT CARD AT TIME OF PURCHASE AND SAVE 2% ON ALL ORDERS,
SAVE 5% ON ALL ORDERS OVER \$500 OR SAVE 10% ON ALL ORDERS OVER \$1000**

PVC DWV SCHEDULE 40



**VALVES,
FITTINGS, AND
PIPE REPAIR**

PVC DWV SCHEDULE 40 90° ELBOW W/SIDE INLET HUB X HUB



CASE QTY
72-910 3" x 3" x 1-1/2" (25) **12.37**
72-911 3" x 3" x 2" (20) **11.67**

PVC DWV SCHEDULE 40 90° CLOSET ELL SPG X HUB



CASE QTY
72-909 4" x 3" SPG x Hub (10) . **11.30**

PVC DWV SCHEDULE 40 SANITARY TEES HUB X HUB X HUB



CASE QTY
72-875 1-1/2" Hub x Hub x Hub (100) **2.01**
72-880 2" x 1-1/2" x 1-1/2" (50) **2.59**
72-881 2" x 1-1/2" x 2" (50) **3.14**
72-882 2" x 2" x 1-1/2" (50) **2.62**
72-876 2" Hub x Hub x Hub (35) **2.96**
72-883 3" x 3" 1-1/2" (20) **4.82**
72-884 3" x 3" x 2" (20) **5.67**
72-877 3" Hub x Hub x Hub (20) **7.58**
72-885 4" x 4" x 1-1/2" (10) **13.68**
72-886 4" x 4" x 2" (10) **12.36**
72-887 4" x 4" x 3" (10) **16.78**
72-878 4" Hub x Hub x Hub (10) **13.20**

PVC DWV SCHEDULE 40 2-WAY CLEANOUT TEES HUB X HUB X HUB



CASE QTY
72-914 3" Hub x Hub x Hub (10) **18.10**
72-915 4" Hub x Hub x Hub (5) **23.42**

PVC DWV SCHEDULE 40 FITTING TRAP ADAPTERS W/NUT & WASHER SPG X MIPT



CASE QTY
72-988 1-1/2" Spg x 1-1/4" Mip. . (50) **NEW** **1.97**
72-912 1-1/2" Spg x Mip. (50) **1.51**
72-913 2" Spg x Mip (25) **5.16**

PVC DWV SCHEDULE 40 DOUBLE SANITARY TEES HUB X HUB X HUB X HUB



CASE QTY
72-924 1-1/2" (50) **4.12**
72-928 2" x 2" x 1-1/2" x 1-1/2" . (25) **4.56**
72-925 2" (25) **6.04**
72-929 3" x 3" x 1-1/2" x 1-1/2" . (20) **9.69**
72-930 3" x 3" x 2" x 2" Red (20) **10.19**
72-926 3" (5) **16.90**
72-931 4" x 4" x 2" x 2" Red (5) **22.46**
72-932 4" x 4" x 3" x 3" Red (5) **23.05**
72-927 4" (5) **27.16**

PVC DWV SCHEDULE 40 TEST TEES HUB X HUB X FIPT



CASE QTY
72-916 1-1/2" Hub x Hub x Fipt . (50) **3.64**
72-917 2" Hub x Hub x Fipt (20) **4.49**
72-918 3" Hub x Hub x Fipt (10) **8.96**
72-919 4" Hub x Hub x Fipt (10) **16.65**

PVC DWV SCHEDULE 40 TEST TEE WITH PLUGS HUB X HUB X FIPT



CASE QTY
72-920 1-1/2" Hub x Hub x Fipt . (50) **5.09**
72-921 2" Hub x Hub x Fipt (50) **5.88**
72-922 3" Hub x Hub x Fipt (10) **11.22**
72-923 4" Hub x Hub x Fipt (10) **17.66**

PVC DWV SCHEDULE 40 DOUBLE FIXTURE TEE HUB X HUB X HUB X HUB



CASE QTY
72-933 2" (25) **11.39**

HODES CO
PROFFERED PLUMBING PRODUCTS
Case Lot Pricing
available at
www.HodesCo.com

**USE YOUR CREDIT CARD AT TIME OF PURCHASE AND SAVE 2% ON ALL ORDERS,
SAVE 5% ON ALL ORDERS OVER \$500 OR SAVE 10% ON ALL ORDERS OVER \$1000**

FAX 1-800-982-5934 www.HODES CO .com PHONE 1-800-777-6500
PROFFERED PLUMBING PRODUCTS **147**

DWV SCHEDULE 40



PVC DWV SCHEDULE 40

**PVC DWV SCHEDULE 40
TEE WITH 90°
LEFT INLET
HUB X HUB X HUB X HUB**



CASE QTY

72-934	3" x 3" x 3" x 1-1/2"	(15)	16.28
72-935	3" x 3" x 3" x 2"	(10)	16.38
72-936	4" x 4" x 4" x 2"	(5)	28.04

**PVC DWV SCHEDULE 40
TEE WITH 90°
RIGHT INLET
HUB X HUB X HUB X HUB**



CASE QTY

72-937	3" x 3" x 3" x 1-1/2"	(15)	16.28
72-938	3" x 3" x 3" x 2"	(10)	16.38
72-939	4" x 4" x 4" x 2"	(5)	28.04

**PVC DWV SCHEDULE 40
MALE
ADAPTERS
HUB X MIPT**



CASE QTY

72-865	1-1/2" Hub x Mipt	(100)	1.07
72-866	2" Hub x Mipt	(100)	1.39
72-867	3" Hub x Mipt	(20)	3.99
72-868	4" Hub x Mipt	(10)	8.84

**PVC DWV SCHEDULE 40
TRAP
ADAPTERS
HUB X SJ**



CASE QTY

72-940	1-1/2" Hub x SJ	(100)	1.51
72-941	1-1/2" x 1-1/4" Hub x SJ	(100)	1.60

**PVC DWV SCHEDULE 40
SOIL PIPE
ADAPTER
HUB X NO HUB**



CASE QTY

72-942	2" Hub x No Hub	(10)	2.88
72-943	3" Hub x No Hub	(10)	4.16
72-944	4" Hub x No Hub	(10)	5.34

**PVC DWV SCHEDULE 40
FITTING CLEANOUT
ADAPTERS
SPG X FIPT**



CASE QTY

72-945	1-1/2" Spg x Fipt	(50)	1.19
72-946	2" Spg x Fipt	(50)	1.69
72-947	3" Spg x Fipt	(20)	4.75
72-948	4" Spg x Fipt	(10)	7.77

**PVC DWV SCHEDULE 40
FEMALE
ADAPTERS
HUB X FIPT**



CASE QTY

72-820	1-1/2" Hub x Fipt	(50)	1.04
72-821	2" Hub x Fipt	(50)	1.76
72-822	3" Hub x Fipt	(20)	4.73
72-823	4" Hub x Fipt	(10)	6.33

**PVC DWV SCHEDULE 40
45° DOUBLE
WYES
HUB X HUB X HUB X HUB**



CASE QTY

72-953	1-1/2"	(25)	6.96
72-957	2" x 2" x 1-1/2" x 1-1/2"	(20)	7.59
72-954	2"	(20)	7.49
72-958	3" x 3" x 2" x 2"	(10)	14.38
72-955	3"	(10)	19.31
72-959	4" x 4" x 2" x 2"	(5)	23.49
72-960	4" x 4" x 3" x 3"	(5)	31.00
72-956	4"	(5)	39.16

**PVC DWV SCHEDULE 40
WYES
HUB X HUB X HUB**



CASE QTY

72-810	1-1/2" Hub x Hub x Hub	(50)	3.07
72-811	2" Hub x Hub x Hub	(25)	3.60
72-812	3" Hub x Hub x Hub	(20)	9.30
72-813	4" Hub x Hub x Hub	(10)	17.21
72-949	2" x 2" x 1-1/2"	(50)	4.45
72-950	3" x 3" x 1-1/2"	(20)	6.22
72-951	3" x 3" x 2"	(20)	7.03
72-952	4" x 4" x 3"	(10)	13.69

**PVC DWV SCHEDULE 40
SANITARY STREET
TEES
SPG X HUB X HUB**



CASE QTY

72-961	1-1/2" Spg x Hub x Hub	(50)	6.01
72-962	2" Spg x Hub x Hub	(20)	6.55
72-963	3" Spg x Hub x Hub	(30)	10.91
72-964	4" Spg x Hub x Hub	(10)	28.48

**USE YOUR CREDIT CARD AT TIME OF PURCHASE AND SAVE 2% ON ALL ORDERS,
SAVE 5% ON ALL ORDERS OVER \$500 OR SAVE 10% ON ALL ORDERS OVER \$1000**

PVC DWV SCHEDULE 40



**VALVES,
FITTINGS, AND
PIPE REPAIR**

PVC DWV SCHEDULE 40 LONG TURN TEES WYE HUB X HUB X HUB



CASE QTY

72-965	1-1/2" Hub x Hub x Hub (20)	4.37
72-966	2" Hub x Hub x Hub (20)	5.21
72-967	3" Hub x Hub x Hub (10)	12.62
72-968	4" Hub x Hub x Hub (5)	22.44
72-969	2" x 2" x 1-1/2" (10)	6.29
72-970	3" x 3" x 2" (20)	8.33
72-971	4" x 4" x 3" (5)	16.95

PVC DWV SCHEDULE 40 COUPLINGS WITH STOP HUB X HUB



CASE QTY

72-831	1-1/2" Hub x Hub (100)	.53¢
72-832	2" Hub x Hub (100)	.84¢
72-833	3" Hub x Hub (50)	2.55
72-834	4" Hub x Hub (25)	4.31

PVC DWV SCHEDULE 40 REPAIR COUPLINGS LESS STOP HUB X HUB



CASE QTY

72-972	1-1/2" Hub x Hub (20)	3.01
72-973	2" Hub x Hub (20)	2.11
72-974	3" Hub x Hub (20)	5.31
72-975	4" Hub x Hub (20)	10.19

PVC DWV SCHEDULE 40 FLUSH REDUCER BUSHINGS SPG X HUB



CASE QTY

72-976	2" x 1-1/2" Spg x Hub . . . (100)	1.05
72-977	3" x 1-1/2" Spg x Hub . . . (50)	5.06
72-978	3" x 2" Spg x Hub (30)	2.64
72-979	4" x 3" Spg x Hub (10)	4.06

PVC DWV SCHEDULE 40 PRESSURE CAP HUB



CASE QTY

72-980	1-1/2" Hub (25)	2.21
72-981	2" Hub (25)	4.07
72-982	3" Hub (10)	6.36
72-983	4" Hub (10)	9.09

PVC DWV SCHEDULE 40 LA PATTERN P-TRAP W/SLIP JOINT INLET HUB X SLIP JOINT



CASE QTY

56-416	1-1/2" x (1-1/4" or 1-1/2") (35)	8.42
--------	----------------------------------	-------------

PVC DWV SCHEDULE 40 P-TRAP W/CLEANOUT PLUG HUB X HUB



CASE QTY

56-417	1-1/2" Hub x Hub (50)	6.37
56-418	2" Hub x Hub (25)	10.81

PVC DWV SCHEDULE 40 P-TRAPS HUB X HUB



CASE QTY

56-412	1-1/2" Hub x Hub (25)	3.87
56-413	2" Hub x Hub (20)	5.08
56-414	3" Hub x Hub (10)	17.64
56-415	4" Hub x Hub (5)	40.22

PVC DWV SCHEDULE 40 P-TRAP WITH UNION JOINT HUB X HUB



CASE QTY

56-109	1-1/2" Hub x Hub (50)	5.86
56-117	2" Hub x Hub (25)	10.72



**PAY BY MAJOR CREDIT CARD
WHEN YOU PLACE YOUR ORDER
AND SAVE UP TO AN
ADDITIONAL 10%
OFF OUR ALREADY
INDUSTRY-LOW PRICES!!**

PVC DWV SCHEDULE 40 RETURN BEND HUB X HUB



CASE QTY

72-984	1-1/2" Hub x Hub (20)	3.09
72-985	2" Hub x Hub (35)	5.92
72-986	3" Hub x Hub (10)	16.43
72-987	4" Hub x Hub (5)	32.46

**USE YOUR CREDIT CARD AT TIME OF PURCHASE AND SAVE 2% ON ALL ORDERS,
SAVE 5% ON ALL ORDERS OVER \$500 OR SAVE 10% ON ALL ORDERS OVER \$1000**

FAX 1-800-982-5934 www.HODESCO.com PHONE 1-800-777-6500
PROFFERED PLUMBING PRODUCTS 149

DWV SCHEDULE 40

**VALVES,
FITTINGS, AND
PIPE REPAIR**



AIR CHAMBERS

**MINI-RESTER™
WATER HAMMER
ARRESTER
HOSE TEE**

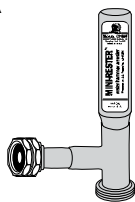

- 4" long
- Can be installed at any angle
- Engineered especially for single fixture residential and commercial installations
- Absorbs water hammer caused by quick-closing valves in washing machines, sinks, tub/showers, toilets, icemakers and dishwashers
- Always remember to install mini-resters on both the hot and cold lines to a plumbing fixture causing water hammer
- Designed especially for in-line use with washing machines
- Lifetime warranty

12 PER BOX
71-530 3/4" M Hose x 3/4" F Hose **21.23**

**MINI-RESTER
WATER HAMMER
ARRESTER**

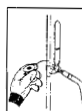

- Installs into any 1/2" female sweat fitting
- Use 95/5 lead-free solder when installing
- Heat female portion of fitting (as shown below)
- Do not braze—do not overheat

12 PER BOX
71-534 1/2" Male Sweat **15.35**

AIR CHAMBER

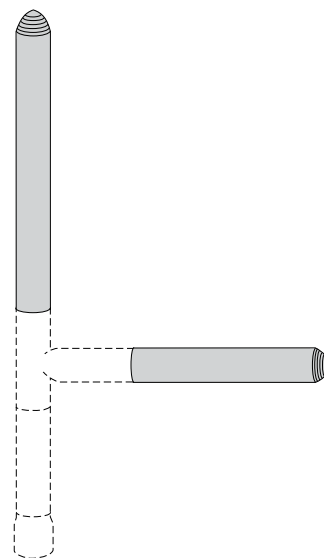

- Preformed copper spun closed
- Straight pattern
- Used as stub-out
- Cut off end after test

TYPE L		100 PER BOX	
71-510	1/2" x 6"	2.35
71-511	1/2" x 8"	2.93
71-513	1/2" x 12"	4.46
TYPE M		100 PER BOX	
71-500	1/2" x 6"	2.11
71-503	1/2" x 12"	3.90

AIR CHAMBERS

**MINI-RESTER™
WATER HAMMER
ARRESTER
1/2" MIP**



- Can be installed at any angle
- Install in-line with 1/2" C x C x FIP brass tee or into any 1/2" FIP port
- Lifetime warranty

12 PER BOX
71-531 1/2" MIP Straight **15.64**

**STUB-OUT
ELBOW
FOR PEX WITH
SQUARE O-STRAP**

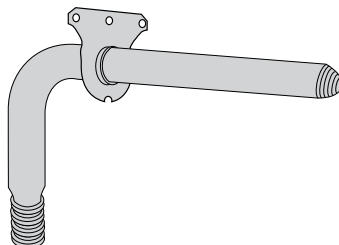

- Preformed copper
- For PEX crimp connection

50 PER BOX
71-193 1/2" PEX x 6-1/2" **4.71**

**MINI-RESTER™
WATER HAMMER
ARRESTER
LIGHT COMMERCIAL & RESIDENTIAL**

(For 1/2" Copper Tube)



Now the famous Hydrarester is available for single fixture use. Install either vertical, horizontal or angled. Install on both hot & cold lines. Internal piston eliminates loss of air over time.

Lifetime warranty

71-533 Tee 5/8" OD x 5/8" OD Comp **23.51**

**USE YOUR CREDIT CARD AT TIME OF PURCHASE AND SAVE 2% ON ALL ORDERS,
SAVE 5% ON ALL ORDERS OVER \$500 OR SAVE 10% ON ALL ORDERS OVER \$1000**

FAX 1-800-982-5934 www.**HODES CO**.com **PHONE 1-800-777-6500**
150

COUPLINGS

See www.HodesCo.com
for Case Lot Pricing



**VALVES,
FITTINGS, AND
PIPE REPAIR**

FERNCO FLEXIBLE COUPLINGS
1056 SERIES
FLEXIBLE
COUPLINGS



HODESCO
FLEXIBLE COUPLINGS
FOR ANY PIPE



NEW

Made of tough PVC, they are strong, resilient, unaffected by soil conditions, resistant to chemicals and normal sewer gases. Leak proof and rust proof.
Used with any pipe: cast iron, plastic, asbestos, cement, clay concrete, steel, fibre, ductile iron, or lead. Furnished with two stainless steel clamps.

Item No.	Size	Qty	Each	Reference No.	Item No.	Size	Case Lot	Price Ea.
70-734	1-1/4" x 1-1/4"	12	4.66	1056-125	78-734	1-1/4" x 1-1/4"	40	3.73
70-775	1-1/2" x 1-1/4"	12	5.30	1056-150/125	78-775	1-1/2" x 1-1/4"	40	4.23
				1056-22/125	78-735	2" x 1-1/4"	40	3.65
70-720	1-1/2" x 1-1/2"	12	4.99	1056-15	78-720	1-1/2" x 1-1/2"	40	4.00
70-733	2" x 1-1/2"	12	5.41	1056-215	78-733	2" x 1-1/2"	40	4.32
70-721	2" x 2"	12	5.26	1056-22	78-721	2" x 2"	40	4.21
				1056-315	78-737	3" x 1-1/2"	20	13.24
70-730	3" x 2"	12	6.23	1056-32	78-730	3" x 2"	20	4.98
70-722	3" x 3"	12	6.79	1056-33	78-722	3" x 3"	40	4.87
				1056-415	78-739	4" x 1/2"	50	19.34
				1056-42	78-742	4" x 2"	50	17.74
70-723	4" x 3"	12	9.09	1056-42	78-723	4" x 3"	40	7.27
70-724	4" x 4"	12	8.44	1056-44	78-724	4" x 4"	40	6.76
70-731	6" x 4"	12	19.64	1056-64	78-731	6" x 4"	20	15.71
70-778	6" x 6"	12	18.05	1056-66	78-778	6" x 6"	20	14.45

FERNCO
FLEXIBLE COUPLING
CLAY TO CAST IRON
(PLASTIC)

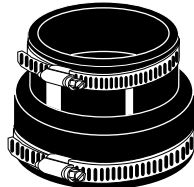

HODESCO
FLEXIBLE COUPLING
CLAY TO CAST IRON
(PLASTIC)



NEW

Made of tough PVC, they are strong, resilient, unaffected by soil conditions, resistant to chemicals and normal sewer gases. Leak proof and rust proof.
Used with any pipe: cast iron, plastic, asbestos, cement, clay concrete, steel, fibre, ductile iron, or lead. Furnished with two stainless steel clamps.

Item No.	Size	Qty	Each	Reference No.	Item No.	Size	Case Lot	Price Ea.
70-735	4" x 3"	12	8.10	1002-43				
70-728	4" x 4"	12	8.44	1002-44	78-728	4" x 4"	10	6.76
70-729	6" x 4"	12	19.64	1002-64	78-729	6" x 4"	10	15.71
70-784	6" x 6"	12	18.06	1002-66	78-784	6" x 6"	10	14.45

MISSION
NO HUB
COUPLING
FLEXIBLE
IAPMO APPROVED



HODESCO
NO HUB
COUPLING



NEW

Item No.	Size	Qty	Each	Reference No.	Item No.	Size	Case Lot	Price Ea.
70-810	1-1/2"	25	5.74	NH 150	78-810	1-1/2"	100	4.59
70-811	2"	25	5.91	NH 22	78-811	2"	100	4.73
70-812	3"	25	6.68	NH 33	78-812	3"	100	5.34
70-813	4"	25	7.53	NH 44	78-813	4"	100	6.02
70-814	2" x 1-1/2"	25	6.68	NH 215	78-814	2" x 1-1/2"	100	5.34
70-817	4" x 3"	25	11.81	NH 43				

**USE YOUR CREDIT CARD AT TIME OF PURCHASE AND SAVE 2% ON ALL ORDERS,
SAVE 5% ON ALL ORDERS OVER \$500 OR SAVE 10% ON ALL ORDERS OVER \$1000**

FAX 1-800-982-5934 www.HODESCO.com PHONE 1-800-777-6500





COUPLINGS

FERNCO FLEXIBLE TUBULAR COUPLING

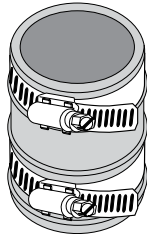

Connects either 1-1/4" or 1-1/2" to either plastic or brass or any drain line

HODESCO FLEXIBLE TUBULAR COUPLING



NEW

Item No.	Size	Qty	Price Ea.	Reference No.	Item No.	Size	Case Lot	Price Ea.
70-828	1-1/4" x 1-1/2"	20	2.68	TC-150	78-828	1-1/4" x 1-1/2"	20	2.15

HODESCO FLEXIBLE TEE



NEW

HODESCO QUICK ELBOW



NEW

Item No.	Ref No.	Size	Qty	Price Ea.
78-761	QT-150	1-1/2" x 1-1/2" x 1-1/2"	20	11.88
78-762	QT-200	2" x 2" x 2"	20	12.86
78-763	QT-300	3" x 3" x 3"	10	19.65
78-764	QT-400	4" x 4" x 4"	5	27.62

Item No.	Ref No.	Size	Qty	Price Ea.
78-765	QL-150	1-1/2" x 1-1/2"	20	9.51
78-766	QL-200	2" x 2"	20	10.09
78-767	QL-300	3" x 3"	10	14.99
78-768	QL-400	4" x 4"	5	22.37

HODESCO FLEXIBLE COUPLING CLAY TO CLAY



NEW

HODESCO



78-770



78-746 thru 78-750



NEW

Item No.	Ref No.	Size	Qty	Price Ea.
78-744	101-44	4" Clay to Clay Coupling	40	13.76

Item No.	Ref No.	Size	Qty	Price Ea.
78-769	KR-64	6" x 4" O-ring	40	7.03
78-770	KT-150	Quick Trap	20	8.34
78-746	1006-44	4" Concrete to CI or PL	20	14.86
78-748	1006-64	6" Concrete to 4" CI or PL	10	31.97
78-750	1006-66	6" Concrete to CI or PL	10	30.11

FERNCO COMPRESSION HUB SEAL "DO-NUTS"

APPROVED BY
SBCC,
BOCA,
UPS

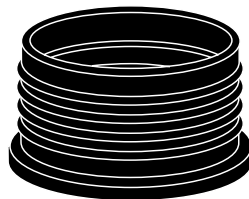

12 PER BOX

- A plasticized do-nut shaped ring to seal sewer pipe joints.
- Eliminates use of cement, mastic or mortar. Used to connect any cast iron, clay, concrete, plastic, fibre or steel Hub to plain end pipe.

70-741	2" SW HUB x 2" CAST IRON, XH	3.13
70-702	3" SW HUB x 3" CAST IRON, XH	4.18
70-704	4" SW HUB x 3" CAST IRON, XH	4.82
70-705	4" SW HUB x 4"	4.40

FLEXIBLE TEST CAP

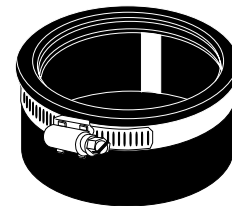

- Neoprene rubber
- Meets Southern Building Code, IAPMO, UPC

EACH OR
QTY PER
SLEEVE

70-396	1-1/2"	(12)	1.99
70-397	2"	(12)	2.21
70-398	3"	(12)	3.12
70-399	4"	(12)	3.93

**USE YOUR CREDIT CARD AT TIME OF PURCHASE AND SAVE 2% ON ALL ORDERS,
SAVE 5% ON ALL ORDERS OVER \$500 OR SAVE 10% ON ALL ORDERS OVER \$1000**

COUPLINGS



**VALVES,
FITTINGS, AND
PIPE REPAIR**

FERNCO® CONDENSATE PIPE CONNECTORS

(1056-075)
(1056-100)



- Easy installation of condensate lines on air conditioning units
- Ideal for any drain application that uses 3/4" & 1" PVC, CPVC or copper drain lines.

70-835 3/4" Sch 40, CPVC or 3/4" & 1" Copper ... **8.72**
70-836 1" Sch 40, CPVC or 1-1/4" Copper ... **8.72**

FERNCO® FLEXIBLE COUPLING ASBESTOS TO CAST IRON (PLASTIC)

(1051-44)



- Made of tough PVC, they are strong, resilient, unaffected by soil conditions, resistant to chemicals and normal sewer gases. Leak proof and rust proof. Used with any pipe: cast iron, plastic, asbestos, cement, clay concrete, steel, fibre, ductile iron, or lead. Furnished with two stainless steel clamps.

EACH OR QTY PER SLEEVE

70-781 4" x 4" (12) .. **8.44**

MISSION SHIELDED TRANSITION COUPLING

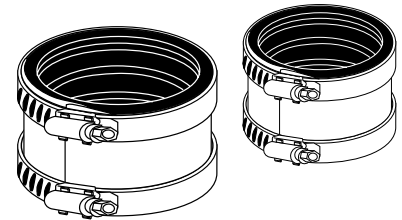

- Band-Seal Couplings are a specially designed coupling for making transitions between different types of pipe. The advantages of these couplings are:
- An exact sized coupling to join Cast Iron, ABS/PVC, Steel and Copper
- Makes transitions between different types of pipe easy and economical
- Conveniently labeled for easy identification of application and sizing
- Neoprene inner sleeve with a heavy 300 Series Stainless Steel Shield
- Shield provides additional support to the joint as well as protection
- Code approved by UPC, B.O.C.A., Southern Building Codes and Canadian Standards Association
- Many code agencies require a shielded coupling to be used for transitioning above ground agencies will not allow a flexible coupling for above ground use
- Over 30 years of proven performance

70-841 1-1/2" CI, PL, **9.29**
(CP 150) or ST to 1-1/2" PL or ST
70-842 2" CI, PL, **9.29**
(CP 200) or ST to 2" PL or ST
70-844 3" CI to 3" PL, **14.31**
(CP 33) ST or XH CI
70-845 4" CI, to 4" PL, **15.72**
(CP 44) ST or XH CI
70-846 1-1/2" CI, PL, **13.19**
(CK 115) or ST to 1-1/2" Copper or 1-1/4" PL
70-847 2" CI, PL, **17.30**
(CK 22) or ST to 2" Copper
or 1-1/4" PL
70-848 2" CI, PL, ST, **15.94**
(CK 215) to 1-1/2" K
or 1-1/4" PL, ST
70-849 3" CI to 3" Copper **18.38**
(CK 33)

FERNCO® FLEXIBLE COUPLING TUBULAR TO CAST IRON (PLASTIC)

(PTC-150)
(PTC-215)

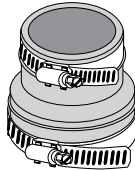

- Made of tough PVC, they are strong, resilient, unaffected by soil conditions, resistant to chemicals and normal sewer gases. Leak proof and rust proof. Used with any pipe: cast iron, plastic, asbestos, cement, clay concrete, steel, fibre, ductile iron, or lead. Furnished with two stainless steel clamps.

QTY PER SLEEVE

70-725 1-1/2" or 1-1/4" x 1-1/2" (12) .. **3.45**
70-788 1-1/2" or 1-1/4" x 2" (12) .. **4.60**

PREMIUM MARINE STYLE HIGHEST GRADE 100% STAINLESS STEEL BAND AND HOUSING

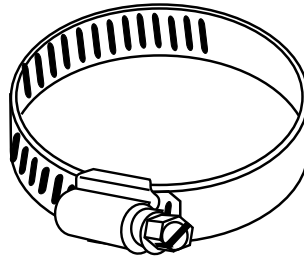

- 300 series stainless steel band and housing
- 305 stainless steel slotted hex head screw
- For use in high corrosion, marine and underground applications
- 100 per case

SOLD 10 CLAMPS PER BOX ONLY

ITEM#	TRADE	MIN.	MAX.	PRICE
SIZE	DIA.	DIA.	EACH	
70-479	6	7/16"	25/32"	1.18
70-753	8	1/2"	29/32"	1.18
70-754	10	9/16"	1-1/16"	1.18
70-755	12	11/16"	1-1/4"	1.18
70-756	16	13/16"	1-1/2"	1.67
70-757	20	13/16"	1-3/4"	1.67
70-408	24	1-1/16"	2"	1.67
70-403	28	1-15/16"	2-1/4"	1.67
70-404	36	1-13/16"	2-3/4"	1.67
	MINI			
70-405	4	7/32"	5/8"	1.39

FERNCO® STAINLESS STEEL 1056 SERIES BANDS FOR FLEXIBLE COUPLINGS

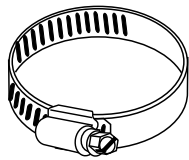

SOLD 10 PER PACKAGE ONLY

(TRADE SIZE)

70-800 1-1/2" (32) **2.87**
70-801 2" (42) **3.17**
70-802 3" (64) **3.67**
70-803 4" (80) **4.23**
70-804 6" (116) **4.99**
70-805 8" (116) **4.99**

**USE YOUR CREDIT CARD AT TIME OF PURCHASE AND SAVE 2% ON ALL ORDERS,
SAVE 5% ON ALL ORDERS OVER \$500 OR SAVE 10% ON ALL ORDERS OVER \$1000**

**FAX
1-800-982-5934**

www.HODES CO.com



**PHONE
1-800-777-6500**



**CLEANOUT
BUSHING KIT**



- Bushing fits inside SCH 40 pipe
- Kit Includes:
- Bushing
- 16 GA SS cleanout cover
- 3/4" SS screw

NEW

70-326 4" Cleanout Bushing Kit **14.57**

**16 GAUGE
POLISHED STAINLESS STEEL
EXTENSION FLOOR COVER**

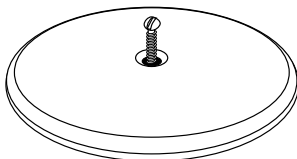

- Includes heavy bolt
 - Heavy polished stainless steel
- 10 PER PACKAGE

70-341 4" **2.63**
70-342 5" **4.07**
70-343 6" **5.56**

**EXTENSION WALLCOVER
POLISHED STAINLESS STEEL
24 GAUGE**

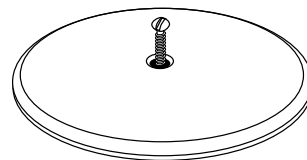

- Includes screw
 - Heavy polished stainless steel
- 10 PER PACKAGE

70-321 4" **1.41**
70-322 6" **2.35**
70-323 8" **4.30**

**DRUM TRAP
COVER
ASSEMBLY**

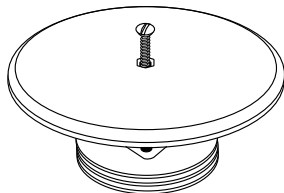

- 5-1/2" polished cover with 2-1/4" stainless steel bolt & 3" countersunk plug

70-336 1/4" x 2-1/4" **10.32**

**DRUM TRAP
COVER
ASSEMBLY**

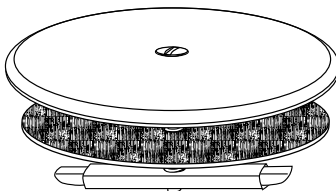

SOLD 6 PER PACKAGE ONLY

- 5-3/8" polished cover with gaskets and spring grip prongs

70-335 Drum Trap Cover **11.82**

**CAST IRON
REPLACEMENT
FLOOR DRAIN
COVERS**

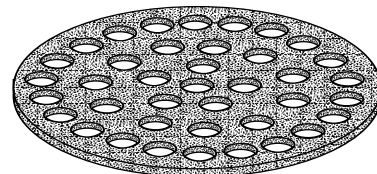

- Green Color

55-100 5" O.D. 1/4" Thick **16.53**
55-101 6" O.D. 1/4" Thick **18.69**
55-102 6-1/4" O.D. 1/4" Thick **20.91**
55-103 6-1/2" O.D. 1/4" Thick **26.59**
55-104 6-5/8" O.D. 1/4" Thick **27.58**
55-105 6-3/4" O.D. 1/4" Thick **27.14**
55-106 7" O.D. 1/4" Thick **30.60**
55-107 7-1/4" O.D. 1/4" Thick **31.56**
55-110 8" O.D. 1/4" Thick **35.48**
55-114 9" O.D. 5/16" Thick **60.45**

**STAINLESS STEEL BOLTS
FOR EXTENSION COVERS**

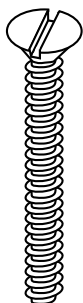

SOLD 10 PER PACKAGE ONLY

70-347 1/4" x 2-1/4" **.94¢**
70-348 1/4" x 4" **1.75**

**CHROMED ZINC
DRUM TRAP
COVER
WITH GASKET**

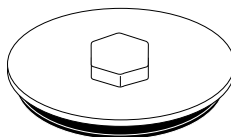

12 PER BOX

70-328 4-1/4" OD 3" MIP **5.32**
GASKETS
52-152 Fibre - Sold 5 Per Package Only .. **.35¢**
52-153 Rubber - Sold 5 Per Package Only .. **.69¢**

**USE YOUR CREDIT CARD AT TIME OF PURCHASE AND SAVE 2% ON ALL ORDERS,
SAVE 5% ON ALL ORDERS OVER \$500 OR SAVE 10% ON ALL ORDERS OVER \$1000**

PLUGS

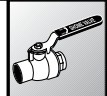

VALVES, FITTINGS, AND PIPE REPAIR

ECONO TEST PLUG

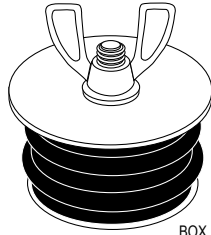

- For capping low or no pressure pipes
- Galvanized steel flanges with molded rubber gaskets
- Galvanized bolt & wing nut

	BOX QTY	
90-566 1-1/2"	(10)	1.63
90-567 2"	(10)	2.54
90-568 3"	(10)	2.94
90-569 4"	(10)	4.70

TEST TITAN™

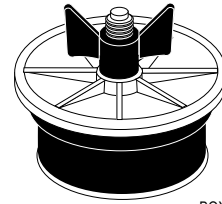

- 100% corrosion resistant
- 4 piece simple design
- Top, plate, wing nut, and bottom plate/bolt made of nylon 66
- Gasket is flexible PVC
- Leak free seal at 7 times the PSI of ordinary plugs

	BOX QTY	
70-930 1-1/2"	(10)	3.49
70-931 2"	(10)	4.00
70-932 3"	(10)	5.55
70-934 3-5/8"	(10)	8.07
70-933 4"	(10)	7.04

CLEAN-OUT GRIPPER PLUG



- For use in cast iron and plastic test tees
- Replace brass plug even when threads are damaged!

	(270168)	(270178)	(270138)	(270188)
	BOX	QTY		
90-590 2"	(10)			10.73
90-591 3"	(10)			12.21
90-592 3-1/2"	(10)			14.37
90-593 4"	(10)			15.76

EXPANDABLE DOLLAR PLUG

The design of the "Gripper"™ uses the mechanical advantage of the inclined planes on the end plates and o-ring. When pressure is applied to the end plates by tightening the wing nut – the o-ring is effortlessly expanded by moving along the inclined surfaces of the plastic end plates – YOU CAN ACTUALLY FEEL THE SMOOTH, EASY MOVEMENT TAKING PLACE!

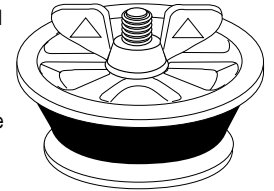

90-555 1-1/2"	5.26
90-556 2"	5.30
90-557 3"	7.30
90-558 4"	8.21

T-CONE EXPANDABLE CLEAN OUT PLUG FOR PLASTIC

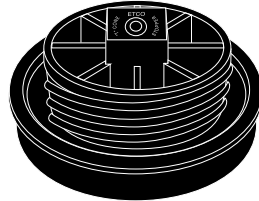

- Raised head
- Reuseable

70-290 1-1/2"	5.48
70-291 2"	5.52
70-292 3"	7.94
70-293 3-1/2"	9.44
70-294 4"	10.25

REAL-TITE PLUG

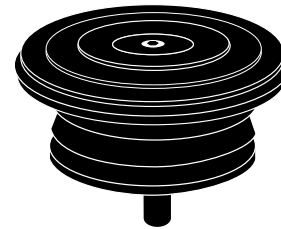

70-330 3"	22.21
70-331 3-1/2"	22.78
70-332 4"	23.64

T-CONE EXPANDABLE CLEAN OUT PLUG FOR IPS THREAD

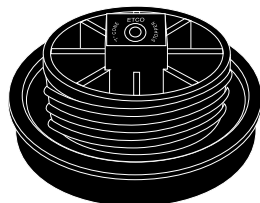

- Raised head
- Reuseable
- For IPS thread

70-295 4"	9.48
-----------------	------



PAY BY MAJOR CREDIT CARD
WHEN YOU PLACE YOUR ORDER
AND SAVE UP TO AN
ADDITIONAL 10%
OFF OUR ALREADY
INDUSTRY-LOW PRICES!!

USE YOUR CREDIT CARD AT TIME OF PURCHASE AND **SAVE 2% ON ALL ORDERS,**
SAVE 5% ON ALL ORDERS OVER \$500 OR SAVE 10% ON ALL ORDERS OVER \$1000

FAX **1-800-982-5934** www. **HODES CO.** .com PHONE **1-800-777-6500**
PROFFERED PLUMBING PRODUCTS 155

**VALVES,
FITTINGS, AND
PIPE REPAIR**



PLUGS

**CAST BRASS
CLEANOUT PLUG
SQUARE HEAD**

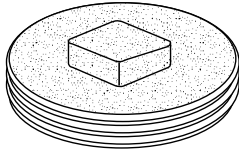

70-300	1-1/2" IPS (1-15/16" DIA)	2.92
70-301	2" IPS (2-3/8" DIA)	3.99
70-302	2-1/2" IPS (2-13/16" DIA)	5.17
70-303	3" IPS (3-7/16" DIA)	6.68
70-304	3-1/2" IPS (3-15/16" DIA)	10.35
70-305	4" IPS (4-7/16" DIA)	11.55
70-313	5" IPS (5-7/16" DIA)	19.92
70-333	6" IPS (6-9/16" DIA)	35.65

**CAST BRASS
CLEANOUT PLUG
COUNTERSUNK HEAD**

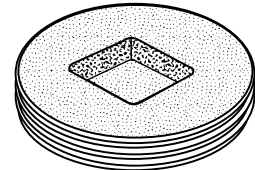

70-306	1-1/2" IPS (1-15/16" DIA)	3.32
70-307	2" IPS (2-3/8" DIA)	4.40
70-308	2-1/2" IPS	7.19
70-309	3" IPS (3-7/16" DIA)	7.78
70-338	3" Tapped for 1/4"-20 Bolt (3-7/16" DIA)	8.19
70-310	3-1/2" IPS (3-15/16" DIA)	9.76
70-311	4" IPS (4-7/16" DIA)	9.96

**LEAD
CLEANOUT PLUG**

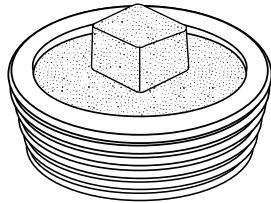

70-451	2" IPS	5.30
70-453	3" IPS	7.80
70-454	3-1/2" IPS	10.64
70-455	4" IPS	11.07
70-456	4-1/2" IPS	14.37

**PLASTIC
CLEANOUT PLUG
COUNTERSUNK HEAD
WITH THREADED
BRASS INSERT**

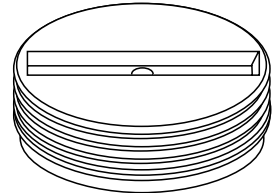

70-410	1-1/2" IPS (1-15/16" DIA)	1.95
70-411	2" IPS (2-3/8" DIA)	2.36
70-413	3" IPS (3-7/16" DIA)	2.94
70-414	3-1/2" IPS (3-15/16" DIA)	3.52
70-415	4" IPS (4-7/16" DIA)	4.13

**GRIP TIP
KNOCKOUT
TEST PLUG**

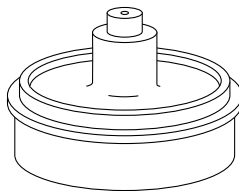

- 2 tips that allow DWV system to be air or water tested
- Perfect debris cover that knocks out in one piece
- Easy to hold stem and a deeper glue surface provides easier installation than standard plugs!

70-416	1-1/2"	PKG QTY	(25)59¢
70-417	2"	(25)71¢	
70-418	3"	(10)82¢	
70-419	4"	(10)94¢	

**URINAL
PLUG
EXPANSION TYPE**

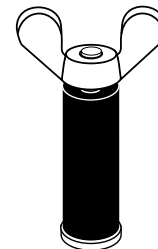

90-525	1/2" Round x 3/4" High	6.50
90-526	3/4" Round x 1 1/8" High	6.94
90-868	1" Round	8.76
90-869	1-1/4"	9.12

PVC PLUGS

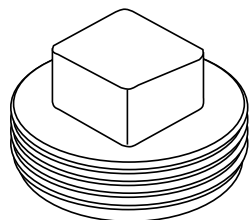

70-315	1-1/2" IPS	1.07
70-316	2" IPS	1.11
70-317	3" IPS	2.16
70-319	4" IPS	2.95
70-324	6" IPS	10.57

HODES CO
PREFERRED PLUMBING PRODUCTS

Case Lot Pricing
available at
www.HodesCo.com

**USE YOUR CREDIT CARD AT TIME OF PURCHASE AND SAVE 2% ON ALL ORDERS,
SAVE 5% ON ALL ORDERS OVER \$500 OR SAVE 10% ON ALL ORDERS OVER \$1000**

HANGERS



VALVES, FITTINGS, AND PIPE REPAIR

PERFORATED STEEL STRAP 3/4" 24 GAUGE

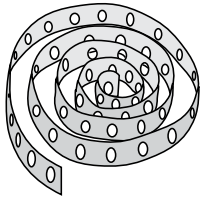

GALVANIZED	
70-200 3/4" x 10'	1.53
70-201 3/4" x 100'	13.81
70-203 10' Rolls – Case of 50 Qty. Price	1.22
COPPER COATED	
70-202 3/4" x 10'	2.37
PLASTIC	
70-620 3/4" x 100' Coil	13.96

SINGLE STUD SUPPORT BRACKET

- Used to reinforce studs or joists when drilled or notched for pipe runs
- 25% more strength than conventional stud support
- 18 gauge galvanized steel

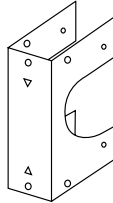

SOLD 25 PER BOX ONLY

70-910 Single Stud Support Bracket	3.11
------------------------------------	------

DOUBLE STUD SUPPORT BRACKET

- Used to reinforce studs or joists when drilled or notched for pipe runs
- 25% more strength than conventional stud support
- 18 gauge galvanized steel

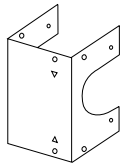

70-911 Double Stud Support Bracket	2.76
------------------------------------	------

TRIPLE STUD SUPPORT BRACKET

- Used to reinforce studs or joists when drilled or notched for pipe runs
- 25% more strength than conventional stud support
- 16 gauge galvanized steel

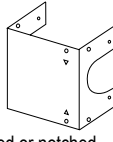

70-912 Triple Stud Support Bracket	3.33
------------------------------------	------

COPPER J HOOKS

- Copper coated—round
- Won't split the wood
- No nails needed

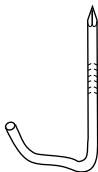

SOLD 100 PER PACKAGE ONLY

70-219 3/4" ID (7/8" OD)	.23¢
--------------------------	------

PERFORATED STEEL STRAP 3/4" 28 GAUGE

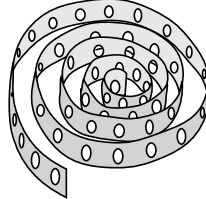

GALVANIZED	
70-198 10' Rolls	1.05
70-199 Box of 50 10' Rolls	.95¢
70-197 100' Roll	9.38

COPPER PLATED TUBE STRAPS WITH EXTRA LONG NAILS

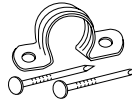

SOLD 100 PER PACKAGE ONLY

70-206 1/2" ID Strap with Nails	.31¢
77-206 1/2" ID Strap Only	.21¢
70-207 3/4" ID Strap with Nails	.31¢
77-207 3/4" ID Strap Only	.21¢
70-208 1" ID Strap Only with Nails NEW	.34¢
COPPER NAILS ONLY	
70-210 Sold in Boxes of 200 Only	.12¢

GALVANIZED WIRE PIPE OR TUBE HOOK

- "Kinked" to grip pipe
- Galvanized

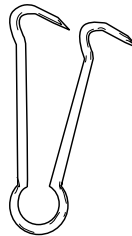

SOLD 50 PER BOX ONLY

70-237 1/2" IP x 6"	.44¢
70-239 3/4" IP x 6"	.46¢
70-245 1" IP x 6"	.53¢

GALVANIZED 2-HOLE PIPE STRAP



NEW

70-180 1/2" 2-Hole Pipe Strap	.13¢
70-181 3/4" 2-Hole Pipe Strap	.22¢
70-182 1" 2-Hole Pipe Strap	.26¢
70-183 1-1/4" 2-Hole Pipe Strap	.36¢
70-184 1-1/2" 2-Hole Pipe Strap	.48¢
70-185 2" 2-Hole Pipe Strap	.69¢

STEEL STUD GUARD

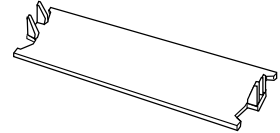

- Protects plumbing pipe from lath nails, etc.
- Heavy 18 gauge steel

SOLD 100 PER BOX ONLY

70-255 1-1/2" X 3"	.23¢
70-254 1-1/2" X 5"	.35¢
70-247 1-1/2" X 6"	.41¢

SOLDER O STRAP COPPER TUBE HANGER 17 GAUGE

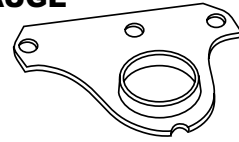

- 17 gauge hanger spot solders to copper tube
- Holes on 1 5/8" centers
- 1/2" & 3/4" nom. tube sizes

SOLD 100 PER PACKAGE ONLY

70-673 1/2" Nom.	.59¢
------------------	------

COPPER COATED WIRE PIPE OR TUBE HOOK

- "Kinked" to grip pipe
- Copper-coated

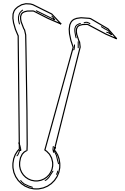

SOLD 50 PER BOX ONLY

70-240 1/2" C x 4"	.44¢
70-249 3/4" C x 2-1/2"	.35¢
70-242 3/4" C x 4"	.46¢
70-243 3/4" C x 6"	.50¢

SINGLE SHOT CLAMP WITH NAIL

- Insulator

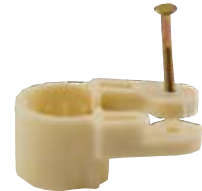

70-628 1/2" Single Shot Clamp w/Nail	.30¢
70-629 3/4" Single Shot Clamp w/Nail	.32¢

RIGHT STRAP

- Multi-functional pipe clamp
- w/preloaded nail



NEW

70-215 1/2" Right Strap CTS	.16¢
70-216 3/4" Right Strap CTS	.21¢
70-217 1" Right Strap CTS	.42¢

USE YOUR CREDIT CARD AT TIME OF PURCHASE AND SAVE 2% ON ALL ORDERS, SAVE 5% ON ALL ORDERS OVER \$500 OR SAVE 10% ON ALL ORDERS OVER \$1000

FAX 1-800-982-5934

www.HODES CO.com

PHONE 1-800-777-6500



**PIPE CLAMP
WHITE-FOR NOM. TUBE**

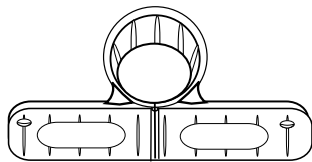

SOLD 100 PER BOX ONLY

70-610	1/2"28¢
70-611	3/4"35¢

**INSULATED SUSPENSION
CLAMP
WHITE-FOR NOM. TUBE**

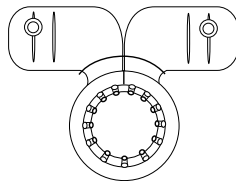

SOLD IN PACKAGE QTY. ONLY

70-605	1/2"(100).....	.28¢
70-606	3/4"(100).....	.35¢
70-607	1"(50).....	.66¢

**PADLOCK™
TUBE STRAP**

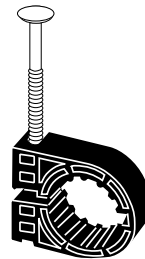

- Pre-loaded nails included
- Perfect for Copper, CPVC, PEX & PB
- Extra strong – full circle strap
- Durable, high density polyethylene is corrosion proof
- Insulates and isolates the tube from the mounting surface reducing water line noise
- Allows tube to expand and contract

SOLD IN PACKAGE QTY. ONLY

70-635	1/2" Padlock Tube Strap	(100)23¢
70-636	3/4" Padlock Tube Strap.	(50)35¢

**TWIN TALON
1/2" OR 3/4" PIPE**

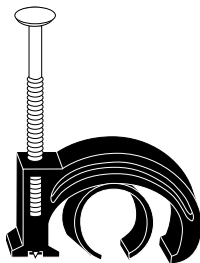

- For copper or plastic
- Furnished with nail
- Accepts both 1/2" & 3/4" pipe— one talon for both jobs!

SOLD 100 PER BOX ONLY

70-229	Twin Talon Combo18¢
--------	------------------	-------	-------------

**TUBE TALON
PLASTIC PIPE HOOK**

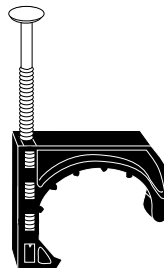

- Non-sag truss design
- For copper or plastic
- Pre-loaded nail
- No corrosion
- Insulates against water line noise
- "Grips" the tube
- Cannot be over-driven

SOLD IN PACKAGE QTY. ONLY

70-220	1/2" Nom.(100).....	.14¢
70-221	3/4" Nom.(100).....	.18¢
70-222	1" Nom.(50).....	.42¢

PLASTIC PIPE STRAP

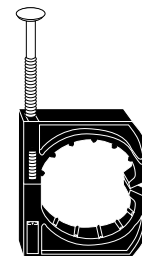

- Non-sag truss design
- Insulates tube completely from wall or ceiling
- Wide band gives secure grip
- Pre-loaded nail

SOLD IN PACKAGE QTY. ONLY

70-223	1/2" Nom.(100).....	.18¢
70-224	3/4" Nom.(100).....	.23¢
70-227	1" Nom.(25).....	.53¢

pipe-tytes inc. U.S. PATENT #419477

METAL STUD INSULATORS

Protects copper & polybutylene tubing from sharp edges of metal studs. Eliminates pipe rattle & electrolysis by completely isolating the pipe from the metal stud. Fits all 1/2", 3/4", & 1" copper or poly pipe tubing. For use on all metal studs 18 gauge or lighter. Installs in seconds for a neat professional job. Patented offset hole makes for better pipe alignment. Made of tough durable polymer (plastic). Withstands temperatures of 212° Fahrenheit.

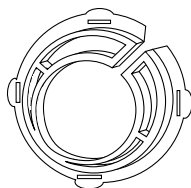

SOLD 100 PER PACKAGE ONLY

70-280	1/2" Pipe-Tytes37¢
70-281	3/4" Pipe-Tytes42¢
70-282	1" Pipe-Tytes46¢

**PIPE INSULATOR
FOR NOM. TUBE**

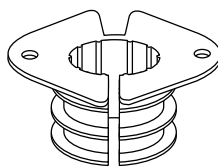

70-622
70-623

SOLD 25 PER PACKAGE ONLY

70-622	1/2" Nom (Short Pattern White)59¢
70-623	3/4" Nom (Short Pattern White)64¢

**MULTI-PURPOSE
HANGERS**

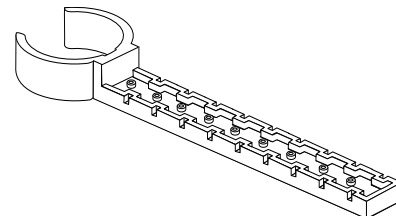

- Can be glued to PVC pipe for support between floors
- Nail holes are 3/4" on center

QTY PER CASE

70-608	1-1/2"-2" White PVC(50).....	2.95
70-609	3"-4" White PVC(25).....	3.17

**USE YOUR CREDIT CARD AT TIME OF PURCHASE AND SAVE 2% ON ALL ORDERS,
SAVE 5% ON ALL ORDERS OVER \$500 OR SAVE 10% ON ALL ORDERS OVER \$1000**

HANGERS



VALVES, FITTINGS, AND PIPE REPAIR

Twin Hangs Tuff Jr.

WITH NAILS

Perfect for CTS piping (copper, CPVC, PB). Great for hydronic heat piping. Minimal heat transfer. Allows for pipe expansion & contraction. Produces straight consistent piping installations with professional results. Safe working temperature: 225°F(107°C). No heat distortion at 250°F.

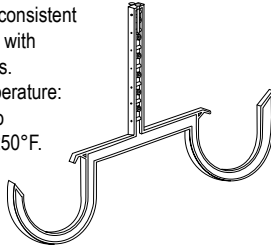

SOLD 50 PER PACKAGE ONLY

70-685 3/4" x 3/4" CTS 1.41

The Hangs Tuff Jr.

WITH NAILS

Perfect for CTS piping (copper, CPVC, PB). Great for hydronic heat piping. Minimal heat transfer. Allows for pipe expansion & contraction. Produces straight consistent piping installations with professional results. Safe working temperature: 225°F(107°C). No heat distortion at 250°F.

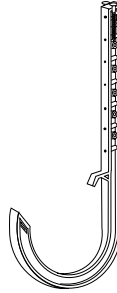

SOLD 50 PER PACKAGE ONLY

70-680 1/2" CTS94¢
 70-681 3/4" CTS 1.05
 70-682 1" CTS 1.18

The Hangs Tuff Jr.

WITH NAILS

Incredibly fast pipe installations. Super-strong "I" beam design. Stem finger locks pipe into hanger. Each hanger comes complete and ready to use with two ring-shank nails preloaded onto the stem. Scooped tip cradles pipe during layout. Nail holes spaced for easy calculation of drainage fall.

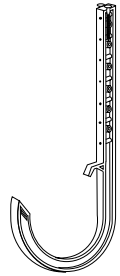

SOLD IN PKG QTY ONLY

70-686 1-1/2" DWV PVC50 1.05
 70-687 2" DWV PVC50 1.08
 70-688 3" DWV PVC50 1.12
 70-689 4" DWV PVC25 1.30

ONE BOLT STAINLESS STEEL PIPE CLAMP

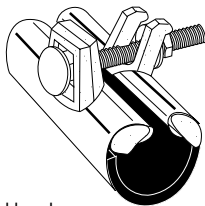

- One piece stainless steel band
- Nickel plated extra wide neoprene
- Gasket molded to the band
- Cadmium iridite plated iron lugs and bolts
- 3" long

PKG QTY.

70-381 1/2" IPS (6) 6.02
 70-382 3/4" IPS (6) 6.11
 70-383 1" IPS (6) 5.90

TWO BOLT STAINLESS STEEL PIPE CLAMP

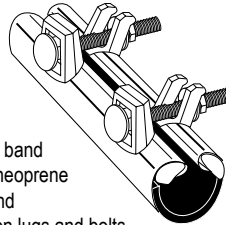

- One piece stainless steel band
- Nickel plated extra wide neoprene
- Gasket molded to the band
- Cadmium iridite plated iron lugs and bolts
- 6" long

PKG QTY.

70-391 1/2" IPS (6) 10.03
 70-392 3/4" IPS (6) 10.98
 70-393 1" IPS (6) 11.71
 70-190 1-1/4" IPS (6) 11.75
 70-191 1-1/2" IPS (6) 13.67
 70-192 2" IPS (6) 15.89

ZIPSTICK™ UNIVERSAL PIPE HANGER

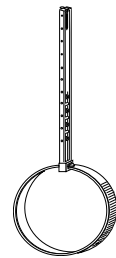

- Includes preloaded rust resistant ring shank nails
- I-beam shank is strong and shatter resistant
- One piece, nylon 66
- No loose parts to find
- Universal cradle hangs any pipe from
- 3/4" IPS to 4" IPS

BUNDLE QTY

70-640 14" White Zipstick Pipe (25) 3.15
 70-641 26" White Zipstick Pipe (25) 4.90

"3 IN 1" ANCHOR KIT



- 100 anchors
- 100 screws
- Drill

70-250 1/4" - 20 Kit (1/4" Drill) 9.10
 70-251 3/16" - 24 Kit (3/16" Drill) 9.10

BELL TYPE HANGER

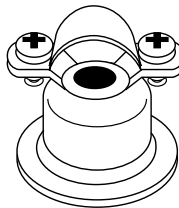

- Hangers for nominal tube size
- Use 1" nominal tubing for stand-off extrusions
- Mounting screen is self-tapping and can penetrate metal studs
- Includes 2 clamps and 1 mounting screw

25 PER BOX

70-692 1/2" 1.77
 70-693 3/4" 1.89
 70-694 1" 2.00

BEAM CLAMP

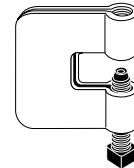

- For 3/8" rod

20 PER BOX

70-445 "C" Clamp 2.13

ZIP-IT WALL ANCHOR



Drills its own hole in wallboard with #2 or #3 Phillips Screwdriver. Then insert screw into anchor to expand the nose. Large collar sets flush, takes paint easily.

SOLD 100 PER BOX ONLY

70-359 Zip-it Anchor with Large Screw 46¢

TOP BEAM CLAMP



- For 3/8" rod
- Malleable iron

70-443 Top Beam Clamp 2.13

USE YOUR CREDIT CARD AT TIME OF PURCHASE AND SAVE 2% ON ALL ORDERS, SAVE 5% ON ALL ORDERS OVER \$500 OR SAVE 10% ON ALL ORDERS OVER \$1000

FAX 1-800-982-5934 www.HODES CO.com PHONE 1-800-777-6500
 PROFFERED PLUMBING PRODUCTS 159

HANGERS



**TOP PLATE
CONNECTOR**



70-441 SHOWN

• Maximum recommended load 180 lbs

70-441	For 3/8" Rod (Galvanized)	1.28
70-437	For 3/8" Rod (Black)	1.63
70-439	For 3/8" Rod (copper)	1.63

**BLACK CLAD
SPLIT RING HANGER**



• Malleable iron
• For 3/8" all thread rod

NEW

70-493	1/2"	.74¢
70-494	3/4"	.83¢
70-495	1"	.94¢
70-496	1-1/4"	1.01
70-497	1-1/2"	1.39
70-498	2"	1.57

**GALVANIZED
CLEVIS HANGER**



70-446	1-1/4"	2.08
70-447	1-1/2"	2.38
70-448	2"	2.65

**16 GAUGE
SHIELD PLATE**



• 16 nail holes

70-196	1-1/2" x 18" Shield Plate	1.15
--------	---------------------------	------

**GALVANIZED
SPLIT RING HANGER**



• Malleable iron
• For 3/8" all thread rod

NEW

70-449	1/2" IPS	1.33
70-450	3/4" IPS	1.55
70-457	1" IPS	1.60
70-458	1-1/4" IPS	2.00
70-459	1-1/2" IPS	2.24
70-460	2" IPS	2.24

**COPPER CLAD
SPLIT RING HANGER**



• Malleable iron
• For 3/8" all thread rod

NEW

70-462	1/2"	1.84
70-463	3/4"	2.01
70-464	1"	2.13
70-468	1-1/4"	2.42
70-469	1-1/2"	2.38

**COPPER CONDUIT
HANGER
W/BOLTS AND NUTS**



• For 3/4" rigid and thin walled copper tubing

SOLD 10 PER PACKAGE ONLY

NEW

70-492	Copper Conduit Hanger	.96¢
--------	-----------------------	------

**16 GAUGE
SHIELD PLATE**



70-194	3-1/2" x 6" Shield Plate	.81¢
--------	--------------------------	------

**HANGER
HARDWARE**



NEW

SOLD PACKAGE QTY ONLY		PKG QTY
70-444	3/8" All Thread Rod	(1) . . . 4.51
70-470	3/8" Rod Coupling	(10)91¢
70-476	3/8" Hex Nut	(25)19¢
70-477	3/8" Flat Steel Washer	(25)19¢

**SIDE BEAM
CONNECTOR**



• Malleable iron
• Maximum recommended load 250 lbs

SOLD 10 PER PACKAGE ONLY

70-442	Side Beam Connector	.98¢
--------	---------------------	------

**AUTO
GRIP RING
HANGER
W/NUT**



• Zinc plated
• For 3/8" rod except 2" to 4" rod

NEW

70-420	1/2" Autogrip Ring Hanger	1.46
70-421	3/4" Autogrip Ring Hanger	1.46
70-422	1" Autogrip Ring Hanger	1.52
70-424	1-1/2" Autogrip Ring Hanger	1.58
70-425	2" Autogrip Ring Hanger	1.99

**GALVANIZED
DWV HANGER**



• Locking screw keeps pipe secure
• Vinyl coated

70-645	1-1/2"	4.60
70-646	2"	4.79
70-647	3"	4.93
70-648	4"	6.00

**GALVANIZED
MINI HANGER
RING
W/BOLTS**



SOLD 25 PER PACKAGE ONLY

NEW

70-427	3/4" Galvanized Mini Hanger	.55¢
70-428	1" Galvanized Mini Hanger	.60¢

**USE YOUR CREDIT CARD AT TIME OF PURCHASE AND SAVE 2% ON ALL ORDERS,
SAVE 5% ON ALL ORDERS OVER \$500 OR SAVE 10% ON ALL ORDERS OVER \$1000**

PIPING ACCESSORIES



VALVES, FITTINGS, AND PIPE REPAIR

ROOF FLASHING

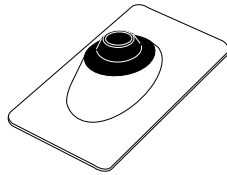

ALUMINUM WITH NEO. COLLAR

53-242	2"	6.04
53-243	3"	6.50
53-244	4"	8.25
GALVANIZED WITH NEO. COLLAR		
53-260	1-1/4" or 1-1/2"	4.79
53-261	2"	6.86
53-262	3"	7.46

COPPER PLATED STEEL SUPPORT BRACKET

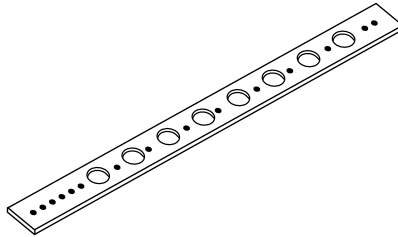

- Designed to position water supplies for sinks, lavatories & other fixtures.
- 1/2" Holes on 2" centers
- Brackets require soldering

70-160	1-1/4" x 20" x 16 GA.	BOX QTY. (50) ..	3.90
--------	----------------------------	------------------	------

UNIVERSAL SLIDER BRACKET

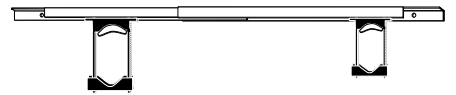

- Clamps fasten any pipe from 1/4" OD to 1-1/8" OD
- Use for 14-26" openings
- Includes:
 - 1 bracket
 - 2 TD clamps
 - 4 mounting screws

70-922	Bracket with Clamps.	4.73
--------	---------------------------	------

ROOF FLASHING

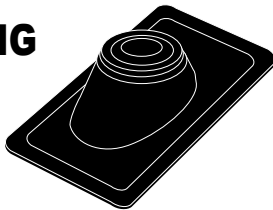

PLASTIC WITH NEO. COLLAR

53-251	2"	4.70
53-252	3"	4.95
ALL NEOPRENE		
53-248	3"	6.14
53-249	4"	9.56

HIGH-RISE FLASHING

53-274	1-1/2" or 2"	17.66
53-275	3" or 4"	18.62

COPPER PLATED STEEL SUPPORT BRACKET

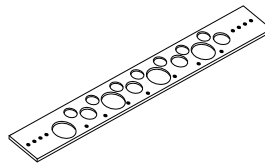

- Designed to position water supplies for lavatories, water heaters and other fixtures where pipes vary in size.
- 1/2" holes on 2" centers
- 70-162 - 3/4" & 1" holes on 4" centers
- 70-166 - 1/2" holes on 2" centers
- Brackets require soldering

SOLD IN BOXES OF 50 ONLY

70-162	3/4", 1" x 18" x 16 GA.	3.90
70-166	1/2", 3/4", 1" x 18" x 16 GA.	3.90

SUPPORT BRACKET

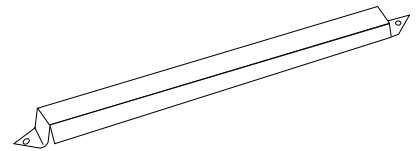

- Bracket adjusts from 12" to 19"
- Nail between studs/joist hold
- Spot solder to copper plated models

SOLD 50 PER BOX ONLY

GALVANIZED STEEL

70-920	Support Bracket	1.53
--------	-----------------------	------

COPPER PLATED

70-921	Support Bracket	2.72
--------	-----------------------	------

MASTER FLASH

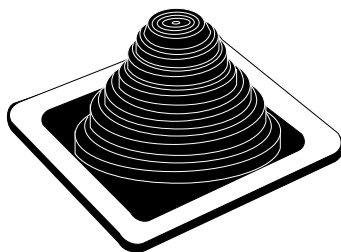

- 1/4" - 4"
- EPDM Master Flash 8" x 8" base

53-272	1/4" - 4" Roof Flashing	35.43
--------	-------------------------------	-------

COPPER TUBE BRACKET 1/2" ANGLE x 16"

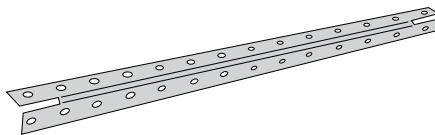

100 PER BOX

70-621	Bracket	1.77
--------	---------------	------

IRON STOVE BOLT ROUND HEAD WITH NUT

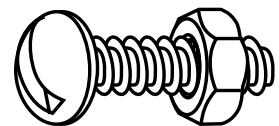

SOLD 100 PER PACKAGE ONLY

70-260	1/4" x 3/4"22¢
70-262	1/4" x 1"24¢
70-263	1/4" x 1-1/4"26¢

USE YOUR CREDIT CARD AT TIME OF PURCHASE AND **SAVE 2% ON ALL ORDERS,**
SAVE 5% ON ALL ORDERS OVER \$500 OR SAVE 10% ON ALL ORDERS OVER \$1000

FAX
1-800-982-5934

www. **HODES CO.** .com
PREFERRED PLUMBING PRODUCTS

PHONE
1-800-777-6500